



Chipsmall Limited consists of a professional team with an average of over 10 year of expertise in the distribution of electronic components. Based in Hongkong, we have already established firm and mutual-benefit business relationships with customers from,Europe,America and south Asia,supplying obsolete and hard-to-find components to meet their specific needs.

With the principle of “Quality Parts,Customers Priority,Honest Operation,and Considerate Service”,our business mainly focus on the distribution of electronic components. Line cards we deal with include Microchip,ALPS,ROHM,Xilinx,Pulse,ON,Everlight and Freescale. Main products comprise IC,Modules,Potentiometer,IC Socket,Relay,Connector.Our parts cover such applications as commercial,industrial, and automotives areas.

We are looking forward to setting up business relationship with you and hope to provide you with the best service and solution. Let us make a better world for our industry!



Contact us

Tel: +86-755-8981 8866 Fax: +86-755-8427 6832

Email & Skype: info@chipsmall.com Web: www.chipsmall.com

Address: A1208, Overseas Decoration Building, #122 Zhenhua RD., Futian, Shenzhen, China



IEC Appliance Inlet C14 with Fuseholder 1- or 2-pole

Plug removal necessary for fuse replacement



Order required accessories separately Snap-in version

Screw-On Version



Description

- Panel Mount :
Screw-on version from front or rear side, snap-in version from front side
- 3 Functions :
Appliance Inlet Protection class I , Fuseholder for fuse-links 5 x 20 mm 1- or 2-pole , with or without voltage selector (step switch)
- V-Lock notch standard
- Quick connect terminals 4.8 x 0.8 mm

Unique Selling Proposition

- Very compact design
- Components internally wired
- Integrated voltage selector
- V-Lock cord retaining

Approvals

- VDE Certificate Number: 40030338
- UL File Number: E93617
- CSA File Number: 38456

Characteristics

- Available with or without internal connections
- Plug removal necessary for fuse-link replacement
- Suitable for use in equipment according to IEC/UL 60950

Other versions on request

- With solder terminals
- Fuse drawer with other voltage values
- For protection class II

References

Alternative: version with line filter [KFA](#)

Weblinks

[pdf datasheet](#), [html-datasheet](#), [General Product Information](#), [RoHS](#), [CHINA-RoHS](#), [REACH](#), [Distributor-Stock-Check](#), [Accessories](#), [Detailed request for product](#)

Technical Data

Ratings IEC	10A / 250VAC; 50Hz	appliance inlet/-outlet	C14 acc. to IEC 60320-1, UL 498, CSA C22.2 no. 42 (for cold conditions) pin-temperature 70 °C, 10A, Protection Class I
Ratings UL/CSA	10A / 250VAC; 60Hz	Fuseholder	1 or 2 pole, Shocksafe category PC2 acc. to IEC 60127-6, for fuse-links 5 x 20mm
Dielectric Strength	> 3kVAC between L-N > 4kVAC between L/N-PE (1 min/50Hz)	Rated Power Acceptance @ Ta 23 °C	5 x 20: 2W (1 pole)/ 1.6W (2-pole) per pole
Allowable Operation Temperature	-25 °C to 70 °C	Power Acceptance @ Ta > 23°C	Admissible power acceptance at higher ambient temperature see derating curves
IP-Protection	from front side IP 40 acc. to IEC 60529	Voltage Selector	optional, step, 2-4 digits
Insulation cover	Suitable for appliances with protection class I acc. to IEC 61140		
Terminal	Quick connect terminals 4.8 x 0.8 mm		
Panel Thickness s	Screw: max 8 mm Mounting screw torque max 0.5Nm Snap-in: 1.5/2/2.5 mm		
Material: Housing	Thermoplastic, black, UL 94V-0		

Detailed information on product approvals, code requirements, usage instructions and detailed test conditions can be looked up in [General Product Information](#)

Dimensions

Screw-on mounting type KEA

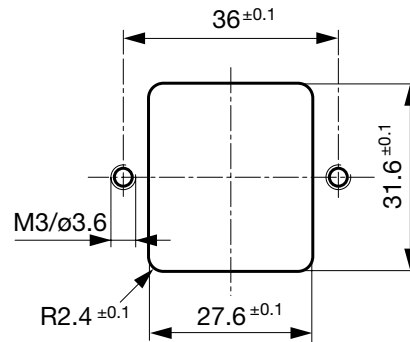
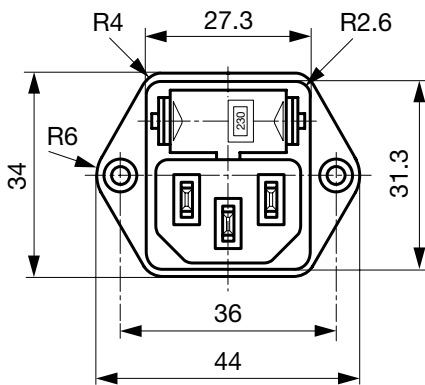
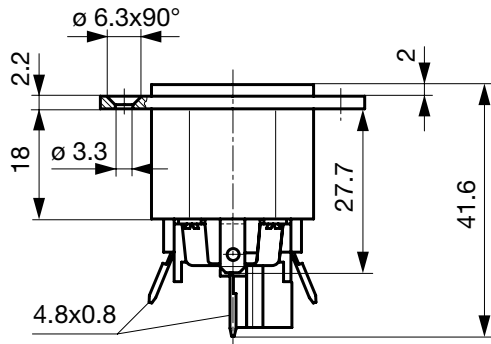

Snap-in mounting type KEA

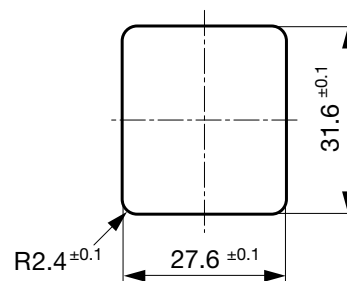
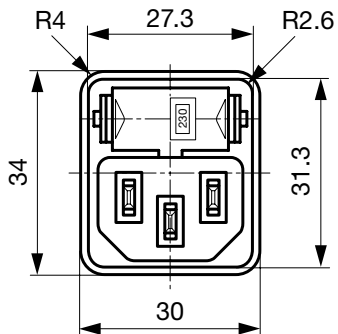
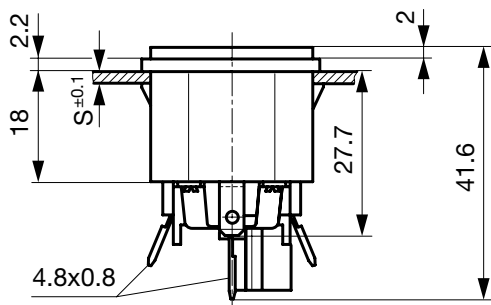

Diagrams

without internal connections
Voltage selector
4-positions, 1-pole

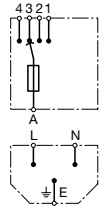

without internal connections
Voltage selector
4-positions, 2-pole

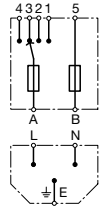

with internal connections
Voltage selector
3-positions, 1-pole

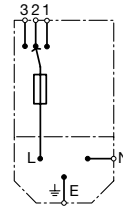

with internal connections
Voltage selector
3-positions, 2-pole

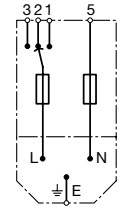

Voltage selector
2-positions
1-pole

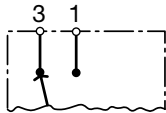

Voltage selector
2-positions
2-pole

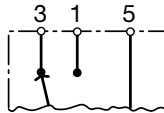

without voltage selector
1-pole

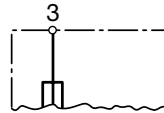

without voltage selector
2-pole

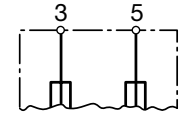

Derating Curves

1-pole

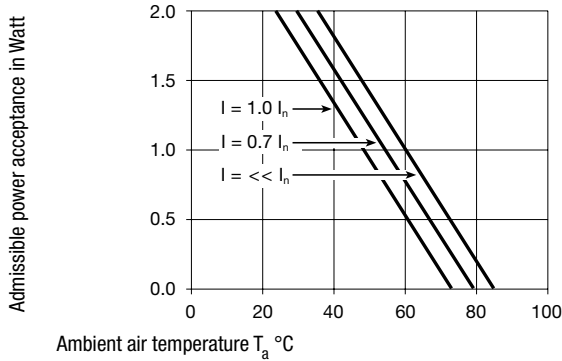

2-pole

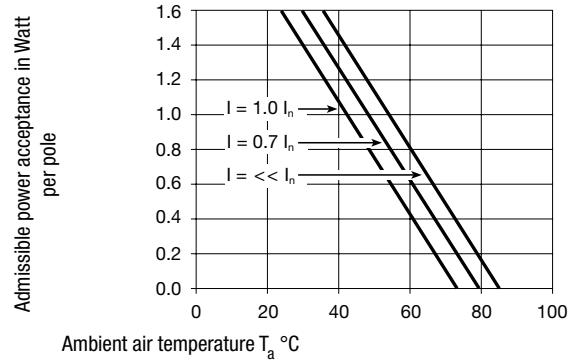

All Variants

Type	Panel mounting	Panel Thickness s [mm]	Fuseholder	Voltage Selector	Internally wired	Order Number
KEA	Snap-in	1.5	1-pole	-	●	4301.0522
KEA	Snap-in	1.5	1-pole	-		4301.2022
KEA	Snap-in	2	1-pole	-	●	4301.0523
KEA	Snap-in	2	1-pole	-		4301.2023
KEA	Snap-in	2.5	1-pole	-	●	4301.0524
KEA	Snap-in	2.5	1-pole	-		4301.2024
KEA	Snap-in	1.5	1-pole	2 pos.		4301.2142
KEA	Snap-in	2	1-pole	2 pos.		4301.2143
KEA	Snap-in	1.5	1-pole	3 pos.	●	4301.0022
KEA	Snap-in	2	1-pole	3 pos.	●	4301.0023
KEA	Snap-in	2.5	1-pole	3 pos.	●	4301.0024
KEA	Snap-in	1.5	1-pole	3/4 digits		4301.2062
KEA	Snap-in	2	1-pole	3/4 digits		4301.2063
KEA	Snap-in	2.5	1-pole	3/4 digits		4301.2064
KEA	Snap-in	1.5	2-pole	-	●	4301.0502
KEA	Snap-in	1.5	2-pole	-		4301.2002
KEA	Snap-in	2	2-pole	-	●	4301.0503

Type	Panel mounting	Panel Thickness s [mm]	Fuseholder	Voltage Selector	Internally wired	Order Number
KEA	Snap-in	2	2-pole	-		4301.2003
KEA	Snap-in	2.5	2-pole	-	●	4301.0504
KEA	Snap-in	2.5	2-pole	-		4301.2004
KEA	Snap-in	1.5	2-pole	2 pos.		4301.2122
KEA	Snap-in	2	2-pole	2 pos.		4301.2123
KEA	Snap-in	2.5	2-pole	2 pos.		4301.2124
KEA	Snap-in	1.5	2-pole	3 pos.	●	4301.0002
KEA	Snap-in	2	2-pole	3 pos.	●	4301.0003
KEA	Snap-in	2.5	2-pole	3 pos.	●	4301.0004
KEA	Snap-in	1.5	2-pole	3/4 digits		4301.2042
KEA	Snap-in	2	2-pole	3/4 digits		4301.2043
KEA	Snap-in	2.5	2-pole	3/4 digits		4301.2044
KEA	Screw	-	1-pole	-	●	4301.0521
KEA	Screw	-	1-pole	-		4301.2021
KEA	Screw	-	1-pole	2 pos.		4301.2141
KEA	Screw	-	1-pole	3 pos.	●	4301.0021
KEA	Screw	-	1-pole	3/4 digits		4301.2061
KEA	Screw	-	2-pole	-	●	4301.0501
KEA	Screw	-	2-pole	-		4301.2001
KEA	Screw	-	2-pole	2 pos.		4301.2121
KEA	Screw	-	2-pole	3 pos.	●	4301.0001
KEA	Screw	-	2-pole	3/4 digits		4301.2041

Most Popular.

Availability for all products can be searched real-time: <http://www.schurter.com/en/Stock-Check/Stock-Check-SCHURTER>

Packaging unit 50 Pcs

Required Accessory

Description

Fusedrawer 2

Fusedrawer für Fuse Links 5x20 mm, with or without Voltage Selector Insert



Fingergrip, 2-pole, Voltage Selector, 110, 150, 220	4301.1014.01
Fingergrip, 2-pole, Voltage Selector, 120, 240	4301.1014.02
Fingergrip, 2-pole, Voltage Selector, 110, 220	4301.1014.03
Fingergrip, 2-pole, Voltage Selector, 115, 220	4301.1014.04

...

Accessories



Wire Harness
Wire harness for SCHURTER products

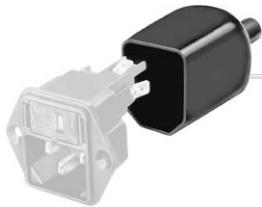

Assorted Covers
Rear Cover

0859.0047



Cord retaining kits
Cord retaining strain relief

Flat head, A

4700.0001

Countersunk, B

4700.0002

Mating Outlets/Connectors

Category / Description

Appliance Outlet Overview complete



IEC Appliance Outlet F, Screw-on Mounting, Front Side, Solder Terminal

4787

IEC Appliance Outlet F, Snap-in Mounting, Front Side, Solder or Quick-connect Terminal

4788

IEC Appliance Outlet F or H, Screw-on Mounting, Front Side, Solder, PCB or Quick-connect Terminal

5091

[Appliance Outlet further types to KEA](#)

Connector Overview complete



4782 Mounting: Power Cord, 3 x 1 mm² / 3 x 18 AWG, Cable, Connector: IEC C13

4782

4022 Mounting: Power Supply Cord, 3 x 1.5 mm², Screw clamps, Connector: IEC C13

4022

4785 Mounting: Power Cord, 3 x 1 mm² / 3 x 18 AWG, Cable, Connector: IEC C13

4785

4300-06 Mounting: Power Cord, 3 x 1 mm² / 3 x 18 AWG, Cable, Connector: IEC C13

4300-06

4012 Mounting: Power Supply Cord, 3 x 1.5 mm², Screw clamps, Connector: IEC C13

4012

[Connector further types to KEA](#)

...

Mating Outlets/Connectors shuttered

Power Cord Overview complete



VAC17KS, North America, V-Lock cord retaining, 3.0 m, Connector C17, SJT 2x18 AWG, black

3-101-794

VAC17KS, North America, V-Lock cord retaining, 2.0 m, Connector C17, SJT 2x18 AWG, black

6051.2801

VAC17KS, North America, V-Lock cord retaining, 2.0 m, Connector C17, SJT 2x18 AWG, white

6051.2811

VAC17KS, United Kingdom, V-Lock cord retaining, 2.0 m, Connector IEC C17, H05VV-F2G1, black

3-101-184

VAC17KS, Switzerland, V-Lock cord retaining, 2.0 m, Connector IEC C17, H05VV-F2G1, black

3-101-185

[Power Cord further types to KEA](#)

...