



Chipsmall Limited consists of a professional team with an average of over 10 year of expertise in the distribution of electronic components. Based in Hongkong, we have already established firm and mutual-benefit business relationships with customers from,Europe,America and south Asia,supplying obsolete and hard-to-find components to meet their specific needs.

With the principle of “Quality Parts,Customers Priority,Honest Operation,and Considerate Service”,our business mainly focus on the distribution of electronic components. Line cards we deal with include Microchip,ALPS,ROHM,Xilinx,Pulse,ON,Everlight and Freescale. Main products comprise IC,Modules,Potentiometer,IC Socket,Relay,Connector.Our parts cover such applications as commercial,industrial, and automotives areas.

We are looking forward to setting up business relationship with you and hope to provide you with the best service and solution. Let us make a better world for our industry!



Contact us

Tel: +86-755-8981 8866 Fax: +86-755-8427 6832

Email & Skype: info@chipsmall.com Web: www.chipsmall.com

Address: A1208, Overseas Decoration Building, #122 Zhenhua RD., Futian, Shenzhen, China



PART CHARACTERISTICS		
NUMBER OF POSITION	ASSEMBLY ITEM NUMBER	MATERIAL
02	43025-0200	'B'
04	43025-0400	
06	43025-0600	
08	43025-0800	
10	43025-1000	
12	43025-1200	'A'
14	43025-1400	'B'
16	43025-1600	'A'
18	43025-1800	'B'
20	43025-2000	
22	43025-2200	
24	43025-2400	'A'

CKT. NO.	DIM. "A" +0.14 -0.10 +0.35 -0.25	DIM. "B"
2	.152/(3.86)	N/A
4	.270/(6.85)	.118/(3.00)
6	.388/(9.85)	.236/(6.00)
8	.506/(12.85)	.354/(9.00)
10	.624/(15.85)	.472/(12.00)
12	.742/(18.85)	.591/(15.00)
14	.860/(21.85)	.709/(18.00)
16	.978/(24.85)	.827/(21.00)
18	1.096/(27.85)	.945/(24.00)
20	1.215/(30.85)	1.063/(27.00)
22	1.333/(33.85)	1.181/(30.00)
24	1.451/(36.85)	1.299/(33.00)

- NOTES:**
- HOUSING MATERIAL:
'A' - UNFILLED POLYESTER, RATED UL, 94V-0, COLOR IS BLACK.
'B' - UNFILLED NYLON, RATED UL, 94V-0, HALOGEN-FREE, COLOR IS BLACK.
 - FINISH: N/A
 - PRODUCT SPECIFICATION: PS-43045
 - PACKAGING SPECIFICATION: PK-43025-001
 - THIS RECEPTACLE MATES WITH 43020, 43045.
 - THIS RECEPTACLE TO BE USED WITH MOLEX FEMALE TERMINAL SERIES 43030 OR 46235. SEE SECTION 'A'-A' FOR TERMINAL ORIENTATION IN HOUSING.
 - FOR OVERMOLDING PARAMETERS SEE ENGINEERING SPECIFICATION #SDS-43025-1000.
 - TOP PULL TABS ARE NOT AVAILABLE ON 2 AND 4 CIRCUIT PARTS.
 - MOLEX RECOMMENDS THE USE OF MICRO-FIT TEST PLUG, SERIES NO. 44242-***** WHENEVER TESTING IS PERFORMED. TEST PLUGS MUST NOT BE USED FOR MAKE OR BREAK UNDER LOAD. MOLEX DOES NOT RECOMMEND USING STANDARD MATING COMPONENTS FOR HARNESS TESTING PURPOSES.
 - SOME HOUSINGS MAY HAVE A SMALL GATE BLEMISH NEAR THE GATE THAT DOES NOT AFFECT FUNCTIONALITY.
 - HOUSINGS HAVE EITHER AN IDENTIFIER RIB OR ENGRAVED '1' SYMBOL TO INDICATE CIRCUIT #1. IDENTIFIER TYPE IS TOOL DEPENDENT AND NOT SELECTABLE.
 - DIMENSION 'A' MEASURED AT DATUM \square -A-
 - THIS PART CONFORMS TO CLASS 'B' REQUIREMENTS OF COSMETIC SPECIFICATION PS-45499-002.

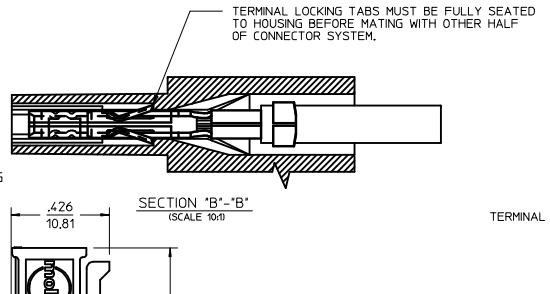
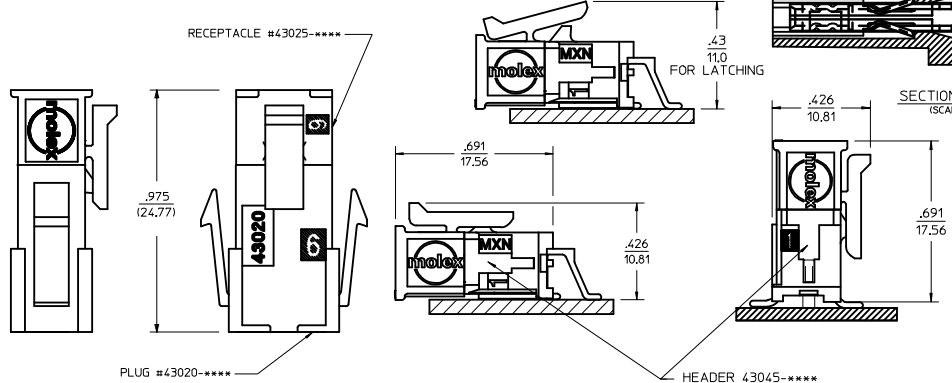
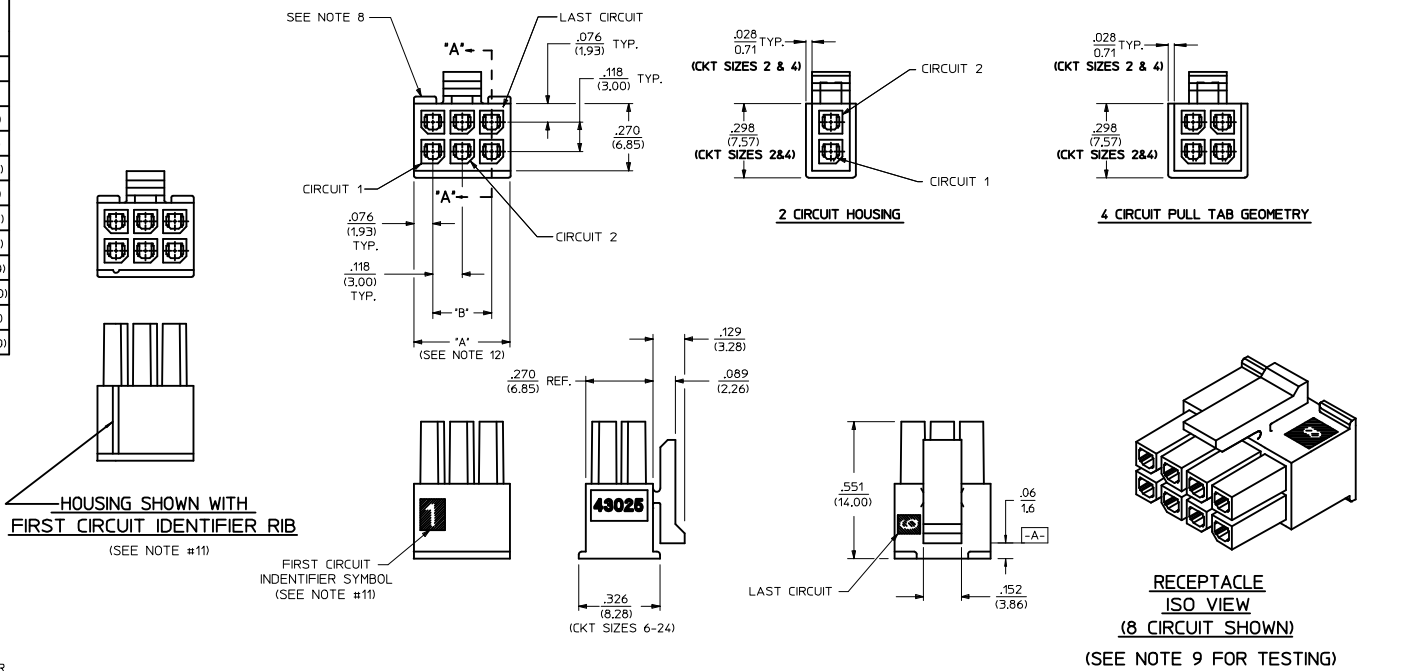

ADD MATED VIEW IEC NO: UCP2016-4677 DRAWN BY: DRYNWAPELDOORN CHKD: JDOX APPR: FMSMTH DATE: 2016/06/03 DATE: 2016/06/09	QUALITY SYMBOLS	GENERAL TOLERANCES (UNLESS SPECIFIED)	DIMENSION STYLE	SCALE	DESIGN UNITS	THIRD ANGLE PROJECTION
	▽=0	4 PLACES ±.010	IN/MM		METRIC	
	▽=0	3 PLACES ±.025		DRAWN BY: A. F. G.	DATE: 1993/01/14	TITLE: MICRO-FIT (3.0) 2 THRU 24 CIRCUIT RECEPTACLE
	▽=0	1 PLACE ±.035		CHECKED BY: B. A. P.	DATE: 1993/01/14	
		ANGULAR ±1/2°	MATERIAL NO.	DOCUMENT NO.		SHEET NO.
		DRAFT WHERE APPLICABLE MUST REMAIN WITHIN DIMENSIONS	SEE CHART	SDA-43025-****		1 OF 1
			THIS DRAWING CONTAINS INFORMATION THAT IS PROPRIETARY TO MOLEX INCORPORATED AND SHOULD NOT BE USED WITHOUT WRITTEN PERMISSION			

NOTES:

- 1) OVERMOLDED MATERIAL SHOULD NOT ENCAPSULATE THE TERMINAL IN AND AROUND THE WIRE CRIMP AREA.
- 2) TERMINALS MUST BE CENTERED AND PERPENDICULAR INSIDE THE RECEPTACLE HOUSING BEFORE AND AFTER OVERMOLDING.
- 3) DEVICE USED TO CENTER TERMINALS MUST NOT EXCEED .020 SQUARE IN ORDER TO PREVENT TERMINAL DEFORMATION.
- 4) OVERMOLD TOOLING MUST NOT DAMAGE INTERNAL OR EXTERNAL FEATURES OF CABLE ASSEMBLY.
- 5) THE OVERMOLDING TEMPERATURES DURING PROCESSING MUST NOT EXCEED 320°F
- 6) REMOVAL OF CABLE ASSEMBLY FROM THE TOOLING MUST NOT IN ANY WAY DAMAGE THE SUPPLIED COMPONENTS.
- 7) MOLEX IS RESPONSIBLE ONLY FOR COMPONENTS SUPPLIED TO THE OVERMOLDER, BUT NOT FOR NONCONFORMANCES INDUCED DURING THE OVERMOLDING PROCESS, SUCH AS OVERMOLD MATERIAL IN THE CONTACT AREA, TERMINALS THAT ARE EITHER OUT OF CENTER OR LACK OF TERMINAL MOBILITY AFTER BEING OVERMOLDED, AND ANY DEFORMATION TO TERMINALS OR HOUSINGS IN GENERAL.

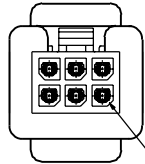
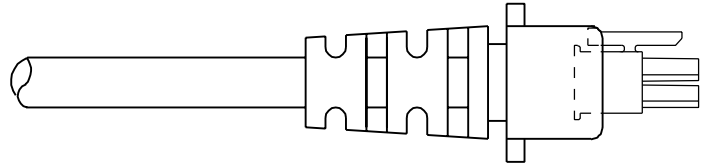

TERMINALS MUST BE CENTERED IN RECEPTACLE PRIOR TO OVERMOLDING

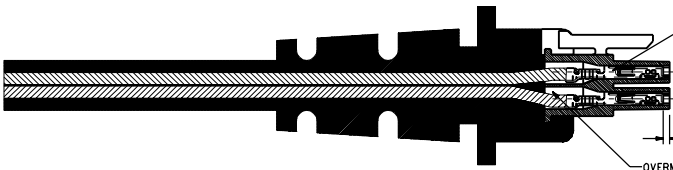
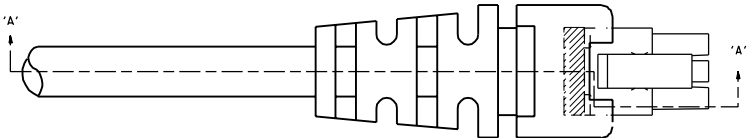

TERMINALS SHOULD BE FULLY SEATED (APPROXIMATELY .030/(0.76) FROM TOP OF SILOS) BEFORE OVERMOLDING

.030 (0.76) REF.

OVERMOLD MATERIAL SHOULD NOT PROCEED PASS WIRE CRIMP

SECTION 'A-A'

B	REVISED PER EEM 10-0172	BAP
A	REVISED PER EEM 14-0130	BAP
	06/23/94	BAP

DIMS: SHOWN METRIC; DIMS: UNLESS OTHERWISE SPECIFIED		REVISE ONLY ON CAD SYSTEM	
TITLE: MICRO-FIT (3.0) OVERMOLDING SPECIFICATIONS		DATE: 06/23/94	
DRAWN BY: BAP		PART NO: SDES-43025-1000	
CHECKED BY: BAP		SCALE: 4:1	
DATE: 06/23/94		MOLEX INCORPORATED	
MOLEX INCORPORATED		MOLEX INCORPORATED	