



Chipsmall Limited consists of a professional team with an average of over 10 year of expertise in the distribution of electronic components. Based in Hongkong, we have already established firm and mutual-benefit business relationships with customers from,Europe,America and south Asia,supplying obsolete and hard-to-find components to meet their specific needs.

With the principle of “Quality Parts,Customers Priority,Honest Operation,and Considerate Service”,our business mainly focus on the distribution of electronic components. Line cards we deal with include Microchip,ALPS,ROHM,Xilinx,Pulse,ON,Everlight and Freescale. Main products comprise IC,Modules,Potentiometer,IC Socket,Relay,Connector.Our parts cover such applications as commercial,industrial, and automotives areas.

We are looking forward to setting up business relationship with you and hope to provide you with the best service and solution. Let us make a better world for our industry!



Contact us

Tel: +86-755-8981 8866 Fax: +86-755-8427 6832

Email & Skype: info@chipsmall.com Web: www.chipsmall.com

Address: A1208, Overseas Decoration Building, #122 Zhenhua RD., Futian, Shenzhen, China



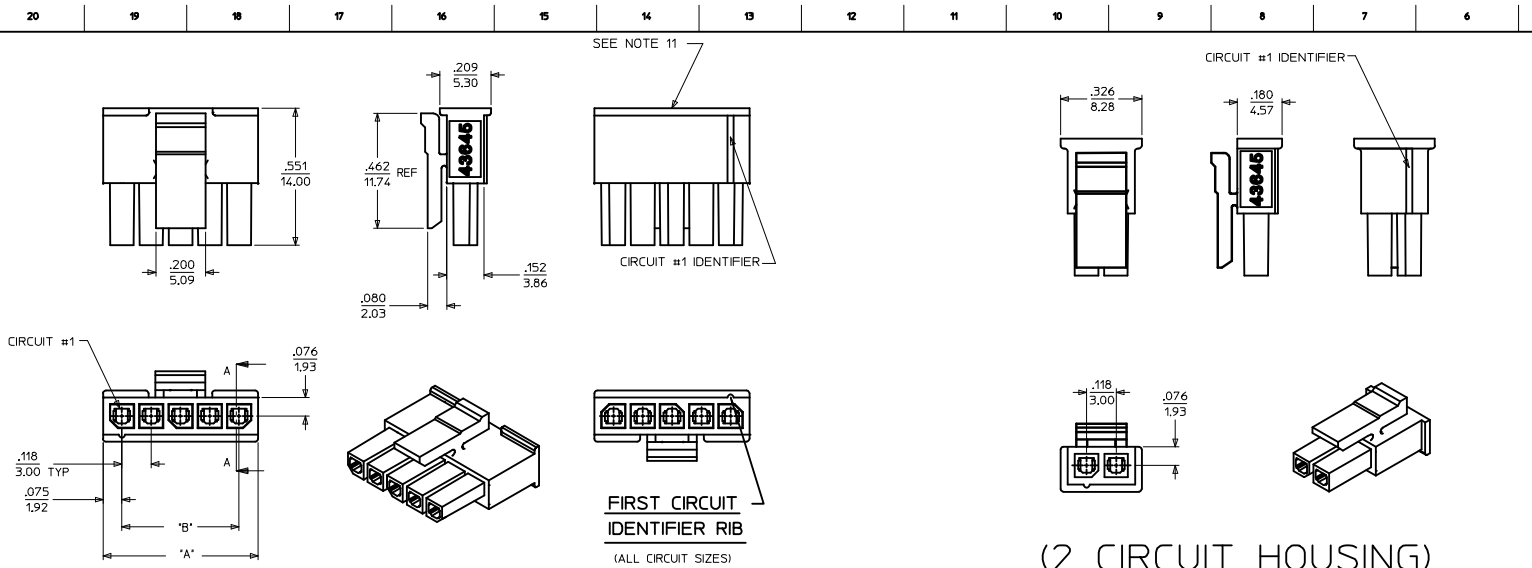

(3-12 CIRCUIT HOUSING)

ITEM NUMBER	NUMBER OF CIRCUIT	DIM. 'A'	DIM. 'B'	MATERIAL
43645-0200	02	SEE DETAIL	.118/(3.00)	'B'
43645-0300	03	.388/(9.85)	.236/(6.00)	
43645-0400	04	.506/(12.85)	.354/(9.00)	'A'
43645-0500	05	.624/(15.85)	.472/(12.00)	
43645-0600	06	.742/(18.85)	.591/(15.00)	
43645-0700	07	.860/(21.85)	.709/(18.00)	
43645-0800	08	.978/(24.85)	.827/(21.00)	
43645-0900	09	1.096/(27.85)	.945/(24.00)	
43645-1000	10	1.215/(30.85)	1.063/(27.00)	
43645-1100	11	1.333/(33.85)	1.181/(30.00)	
43645-1200	12	1.451/(36.85)	1.299/(33.00)	

(2 CIRCUIT HOUSING)

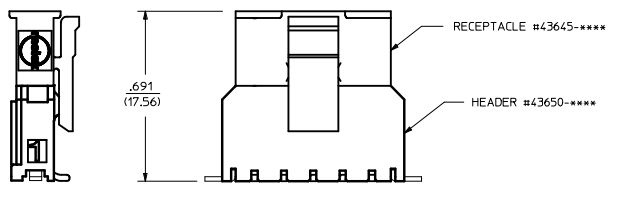

MATED MICRO-FIT CONNECTOR

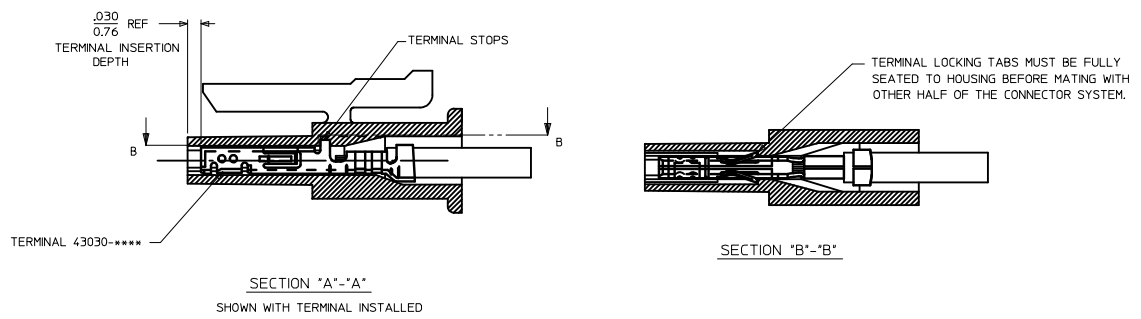

NOTES:

- HOUSING MATERIAL:
 "A" - UNFILLED POLYESTER, RATED UL, 94V-0, COLOR IS BLACK.
 "B" - UNFILLED NYLON, RATED UL, 94V-0, HALOGEN-FREE, COLOR IS BLACK.
 FINISH : N/A
- PRODUCT SPECIFICATION : PS-43650
- PACKAGING SPECIFICATION: PK-43645-001
- THIS RECEPTACLE ACCEPTS MOLEX MICRO FIT FEMALE CRIMP TERMINALS ONLY. SEE MOLEX DRAWING SD-43030-**** FOR SPECIFICATIONS.
- SEE SECTION 'A'-'A' FOR TERMINAL ORIENTATION IN HOUSING.
- FOR OVERMOLDING PARAMETERS SEE ENGINEERING SPECIFICATION #SDS-43025-1000.
- THIS RECEPTACLE MATES WITH MOLEX PCB HEADER 43650 SERIES AND MOLEX PLUG 43640 SERIES (WIRE TO WIRE APPLICATIONS).
- SOME HOUSINGS MAY HAVE A SMALL GATE BLEMISH NEAR THE GATE LOCATION THAT DOES NOT AFFECT FUNCTIONALITY.
- MOLEX RECOMMENDS THE USE OF MICRO-FIT TEST PLUG, SERIES 44242-**** WHENEVER CONTINUITY TESTING IS PERFORMED. TEST PLUGS MUST NOT BE USED TO MAKE OR BREAK UNDER LOAD. MOLEX DOES NOT RECOMMEND USING STANDARD MATING COMPONENTS FOR HARNESS TESTING PURPOSES.
- THIS RIB IS DISCONTINUOUS ON CIRCUIT SIZES 7 THROUGH 12
- PART CONFORMS TO CLASS 'B' REQUIREMENTS OF COSMETIC SPECIFICATION PS-45499-002.

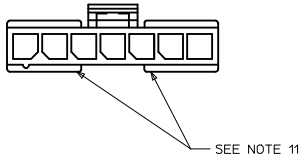

ADD PK SPEC EC NO: UCP2012-450 DFW/MW/STROH 2012/07/03 CHIKDS/SAISEK 2012/07/05 APPRE/SMITH 2012/07/09 F2	QUALITY SYMBOLS ▽=0 ▽=0 ▽=0	GENERAL TOLERANCES (UNLESS SPECIFIED) <table border="1"> <tr> <th></th> <th>mm</th> <th>INCH</th> </tr> <tr> <td>4 PLACES</td> <td>± .10</td> <td>± .004</td> </tr> <tr> <td>3 PLACES</td> <td>± .15</td> <td>± .006</td> </tr> <tr> <td>2 PLACES</td> <td>± .25</td> <td>± .010</td> </tr> <tr> <td>1 PLACE</td> <td>± .35</td> <td>± .014</td> </tr> <tr> <td>0 PLACE</td> <td>± .50</td> <td>± .020</td> </tr> </table>		mm	INCH	4 PLACES	± .10	± .004	3 PLACES	± .15	± .006	2 PLACES	± .25	± .010	1 PLACE	± .35	± .014	0 PLACE	± .50	± .020	DIMENSION STYLE IN/MM DRAWN BY DATE A.F.G. 1995/11/15 CHECKED BY DATE B.A.P. 1995/11/15 APPROVED BY DATE R.J.F. 1995/11/15	SCALE 4:1 DESIGN UNITS METRIC THIRD ANGLE PROJECTION	TITLE MICRO-FIT (3.0) 2 THRU 12 SINGLE ROW RECEPTACLE molex	MATERIAL NO. SEE CHART DOCUMENT NO. SDA-43645-****	SHEET NO. 1 OF 1
		mm	INCH																						
	4 PLACES	± .10	± .004																						
	3 PLACES	± .15	± .006																						
2 PLACES	± .25	± .010																							
1 PLACE	± .35	± .014																							
0 PLACE	± .50	± .020																							
DRAFT WHERE APPLICABLE MUST REMAIN WITHIN DIMENSIONS		SIZE D		THIS DRAWING CONTAINS INFORMATION THAT IS PROPRIETARY TO MOLEX INCORPORATED AND SHOULD NOT BE USED WITHOUT WRITTEN PERMISSION																					

NOTES:

- 1) OVERMOLDED MATERIAL SHOULD NOT ENCAPSULATE THE TERMINAL IN AND AROUND THE WIRE CRIMP AREA.
- 2) TERMINALS MUST BE CENTERED AND PERPENDICULAR INSIDE THE RECEPTACLE HOUSING BEFORE AND AFTER OVERMOLDING.
- 3) DEVICE USED TO CENTER TERMINALS MUST NOT EXCEED .020 SQUARE IN ORDER TO PREVENT TERMINAL DEFORMATION.
- 4) OVERMOLD TOOLING MUST NOT DAMAGE INTERNAL OR EXTERNAL FEATURES OF CABLE ASSEMBLY.
- 5) THE OVERMOLDING TEMPERATURES DURING PROCESSING MUST NOT EXCEED 328° F
- 6) REMOVAL OF CABLE ASSEMBLY FROM THE TOOLING MUST NOT IN ANY WAY DAMAGE THE SUPPLIED COMPONENTS.
- 7) MOLEX IS RESPONSIBLE ONLY FOR COMPONENTS SUPPLIED TO THE OVERMOLDER, BUT NOT FOR NONCONFORMANCES INDUCED DURING THE OVERMOLDING PROCESS, SUCH AS OVERMOLD MATERIAL IN THE CONTACT AREA, TERMINALS THAT ARE EITHER OUT OF CENTER OR LACK OF TERMINAL MOBILITY AFTER BEING OVERMOLDED, AND ANY DEFORMATION TO TERMINALS OR HOUSINGS IN GENERAL.

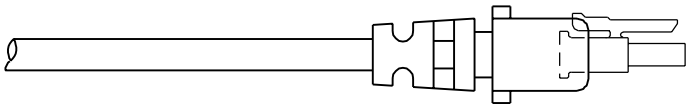
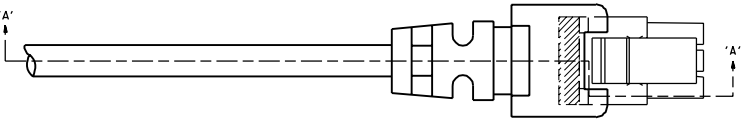

TERMINALS MUST BE CENTERED IN RECEPTACLE PRIOR TO OVERMOLDING

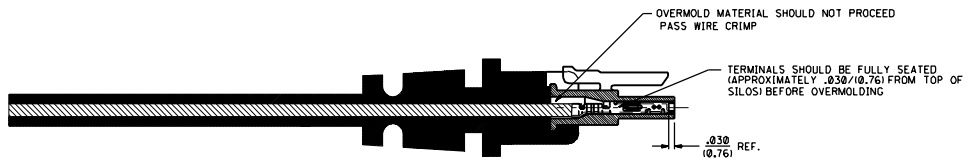

SECTION 'A-A'

A FINAL RELEASE ECN# US-1018 96-82-26 A.0021K

MOLEX INCORPORATED		REV. 1	DATE
PART NO. SDES-43645-1000		REV. 1	DATE 02/26/96
TITLE MICRO-FIT (3.0) SINGLE ROW OVERMOLDING SPECIFICATIONS		DRAWING NO. 1 OF 1	
SCALE 4:1		SHEET NO. 1 OF 1	
DESIGNED BY BAP		DRAWN BY	
CHECKED BY		APPROVED BY	

REVISIONS: REVISE ONLY ON CAD SYSTEM

FOR ORDERING CONTACT MOLEX INC. 1455 S. STANLEY ST. MOLEX INC. 60608