



Chipsmall Limited consists of a professional team with an average of over 10 year of expertise in the distribution of electronic components. Based in Hongkong, we have already established firm and mutual-benefit business relationships with customers from,Europe,America and south Asia,supplying obsolete and hard-to-find components to meet their specific needs.

With the principle of “Quality Parts,Customers Priority,Honest Operation,and Considerate Service”,our business mainly focus on the distribution of electronic components. Line cards we deal with include Microchip,ALPS,ROHM,Xilinx,Pulse,ON,Everlight and Freescale. Main products comprise IC,Modules,Potentiometer,IC Socket,Relay,Connector.Our parts cover such applications as commercial,industrial, and automotives areas.

We are looking forward to setting up business relationship with you and hope to provide you with the best service and solution. Let us make a better world for our industry!



Contact us

Tel: +86-755-8981 8866 Fax: +86-755-8427 6832

Email & Skype: info@chipsmall.com Web: www.chipsmall.com

Address: A1208, Overseas Decoration Building, #122 Zhenhua RD., Futian, Shenzhen, China



SMD ■ Low Power LED 45-21/XK2C-BXXXXXXXXXX/2T



Features

- PLCC-2 package
- Top view white LED
- High luminous intensity output
- Wide viewing angle
- Pb-free
- RoHS compliant

Description

The Everlight 45-21 package has high efficacy, high CRI, low power consumption, wide viewing angle and a compact form factor. These features make this package an ideal LED for all lighting applications.

Applications

- General lighting
- Decorative and Entertainment Lighting
- Indicators
- Illumination
- Switch lights

Product Number Explanation

45-21 / X K 2 C – B XX XX XX XX XX / 2T

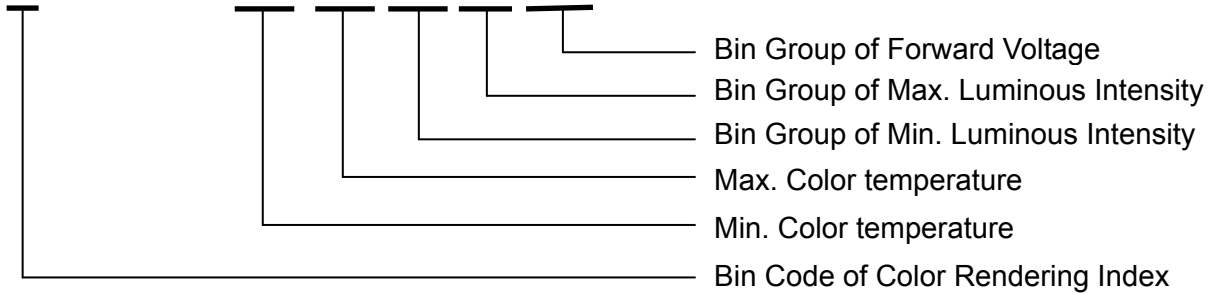

Table of Color Rendering Index

Symbol	Description
M	CRI(Min.) : 60
N	CRI(Min.) : 65
L	CRI(Min.) : 70
Q	CRI(Min.) : 75
K	CRI(Min.) : 80
H	CRI(Min.) : 90

Note:
 Tolerance of Color Rendering Index: ±2

Example:
 45-21/LK2C-B4556AC2CB2/2T

CRI	70(Min.)
CCT	4500K~5650K
I _v	1800mcd~2200mcd
VF	2.9V~3.6V
I _F	20mA

Mass Production list

Product	CRI Min.	CCT(K)	Iv (mcd) Min.	Iv(mcd) Typ.	Iv(mcd) Max.	Φ(lm) Typ.
45-21/LK2C-B56702C4CB2/2T	70	5650K~7000K	2000	2200	2400	6.8
45-21/LK2C-B50634C6CB2/2T	70	5000K~6300K	2200	2400	2600	7.4
45-21/LK2C-B45562C4CB2/2T	70	4500K~5650K	2000	2200	2400	6.8
45-21/LK2C-B38452C4CB2/2T	70	3800K~4500K	2000	2200	2400	6.8
45-21/LK2C-B2832AC2CB2/2T	70	2850K~3250K	1800	2000	2200	6.2

Mass Production list

Product	CRI Min.	CCT(K)	Iv (mcd) Min.	Iv(mcd) Typ.	Iv(mcd) Max.	Φ(lm) Typ.
45-21/QK2C-B56702C4CB2/2T	75	5650K~7000K	2000	2200	2400	6.8
45-21/QK2C-B50632C4CB2/2T	75	5000K~6300K	2000	2200	2400	6.8
45-21/QK2C-B45562C4CB2/2T	75	4500K~5650K	2000	2200	2400	6.8
45-21/QK2C-B3845AC2CB2/2T	75	3800K~4500K	1800	2000	2200	6.2
45-21/QK2C-B2832AC2CB2/2T	75	2850K~3250K	1800	2000	2200	6.2

Note:

1. Tolerance of Luminous flux: ±11%.
2. Lm (Typ.) value just for reference.

Device Selection Guide

Chip Materials	Emitted Color	Resin Color
InGaN	Cool White Neutral White Warm White	Water Clear

Absolute Maximum Ratings (T_{Soldering}=25°C)

Parameter	Symbol	Rating	Unit
Forward Current	I _F	30	mA
Peak Forward Current (Duty 1/10 @10ms)	I _{FP}	100	mA
Power Dissipation	P _d	110	mW
Operating Temperature	T _{opr}	-40 ~ +85	°C
Storage Temperature	T _{stg}	-40 ~ +100	°C
Thermal Resistance (Junction / Soldering point)	R _{th J-S}	75	°C/W
Junction Temperature	T _j	125	°C
Soldering Temperature	T _{sol}	Reflow Soldering : 260 °C for 10 sec. Hand Soldering : 350 °C for 3 sec.	

Note:

The products are sensitive to static electricity and must be carefully taken when handling products

Electro-Optical Characteristics (T_{Soldering}=25°C)

Parameter	Symbol	Min.	Typ.	Max.	Unit	Condition
Luminous intensity	I _v	1800	-----	2600	mcd	I _F =20mA
Forward Voltage	V _F	2.9	-----	3.6	V	I _F =20mA
Viewing Angle	2θ _{1/2}	-----	120	-----	deg	I _F =20mA

Notes:

1. Tolerance of Luminous flux: ±11%.
2. Tolerance of Forward Voltage : ±0.1V.

Bin Range of Luminous intensity

Bin Code	Min.	Max.	Unit	Condition
AC	1800	2000	mcd	I _F =20mA
2C	2000	2200		
4C	2200	2400		
6C	2400	2600		

Note:
 Tolerance of Luminous Intensity: ±11%

Bin Range of Forward Voltage

Group	Bin Code	Min.	Max.	Unit	Condition
B2	36	2.9	3.0	V	I _F =20mA
	37	3.0	3.1		
	38	3.1	3.2		
	39	3.2	3.3		
	40	3.3	3.4		
	41	3.4	3.5		
	42	3.5	3.6		

Note:
 Tolerance of Forward Voltage: ±0.1V.

Bin Range of Chromaticity Coordinates

CCT	Bin Code	CIE_x	CIE_y	CCT	Bin Code	CIE_x	CIE_y
7000K ~6300K	X5	0.3031	0.3327	5650K ~5000K	V5	0.3288	0.3569
		0.3148	0.3444			0.3469	0.3717
		0.3160	0.3332			0.3458	0.3592
		0.3052	0.3224			0.3290	0.3451
	X6	0.3052	0.3224		V6	0.3290	0.3451
		0.3160	0.3332			0.3458	0.3592
		0.3175	0.3204			0.3444	0.3442
		0.3076	0.3108			0.3292	0.3313
6300K ~5650K	W5	0.3148	0.3444	5000K ~4500K	U5	0.3469	0.3717
		0.3288	0.3569			0.3642	0.3829
		0.3290	0.3451			0.3622	0.3716
		0.3160	0.3332			0.3458	0.3592
	W6	0.3160	0.3332		U6	0.3458	0.3592
		0.3290	0.3451			0.3622	0.3716
		0.3292	0.3313			0.3594	0.3557
		0.3175	0.3204			0.3444	0.3442

Note:

1. The value is based on driving current by 20mA.
2. Tolerance of Chromaticity Coordinates: ±0.01

Bin Range of Chromaticity Coordinates

CCT	Bin Code	CIE_x	CIE_y	CCT	Bin Code	CIE_x	CIE_y
4500K ~4100K	T5	0.3642	0.3829	3800K ~3500K	R5	0.3963	0.4035
		0.3811	0.3937			0.4148	0.4161
		0.3783	0.3825			0.4086	0.3995
		0.3622	0.3716			0.3924	0.3909
	T6	0.3622	0.3716		R6	0.3924	0.3909
		0.3783	0.3825			0.4086	0.3995
		0.3741	0.3658			0.4021	0.3822
		0.3594	0.3557			0.3871	0.3739
4100K ~3800K	S5	0.3811	0.3937	3500K ~3250K	Q5	0.4148	0.4161
		0.3963	0.4035			0.4312	0.4234
		0.3924	0.3909			0.4240	0.4065
		0.3783	0.3825			0.4086	0.3995
	S6	0.3783	0.3825		Q6	0.4086	0.3995
		0.3924	0.3909			0.4240	0.4065
		0.3871	0.3739			0.4165	0.3890
		0.3741	0.3658			0.4021	0.3822
3250K ~3050K	P5	0.4312	0.4234	3050K ~2850K	N5	0.4456	0.4287
		0.4456	0.4287			0.4614	0.4333
		0.4376	0.4116			0.4525	0.4162
		0.4240	0.4065			0.4376	0.4116
	P6	0.4240	0.4065		N6	0.4376	0.4116
		0.4376	0.4116			0.4525	0.4162
		0.4294	0.3943			0.4436	0.3991
		0.4165	0.3890			0.4294	0.3943

Note:
 1. The value is based on driving current by 20mA.
 2. Tolerance of Chromaticity Coordinates: ±0.01

The C.I.E. 1931 Chromaticity Diagram

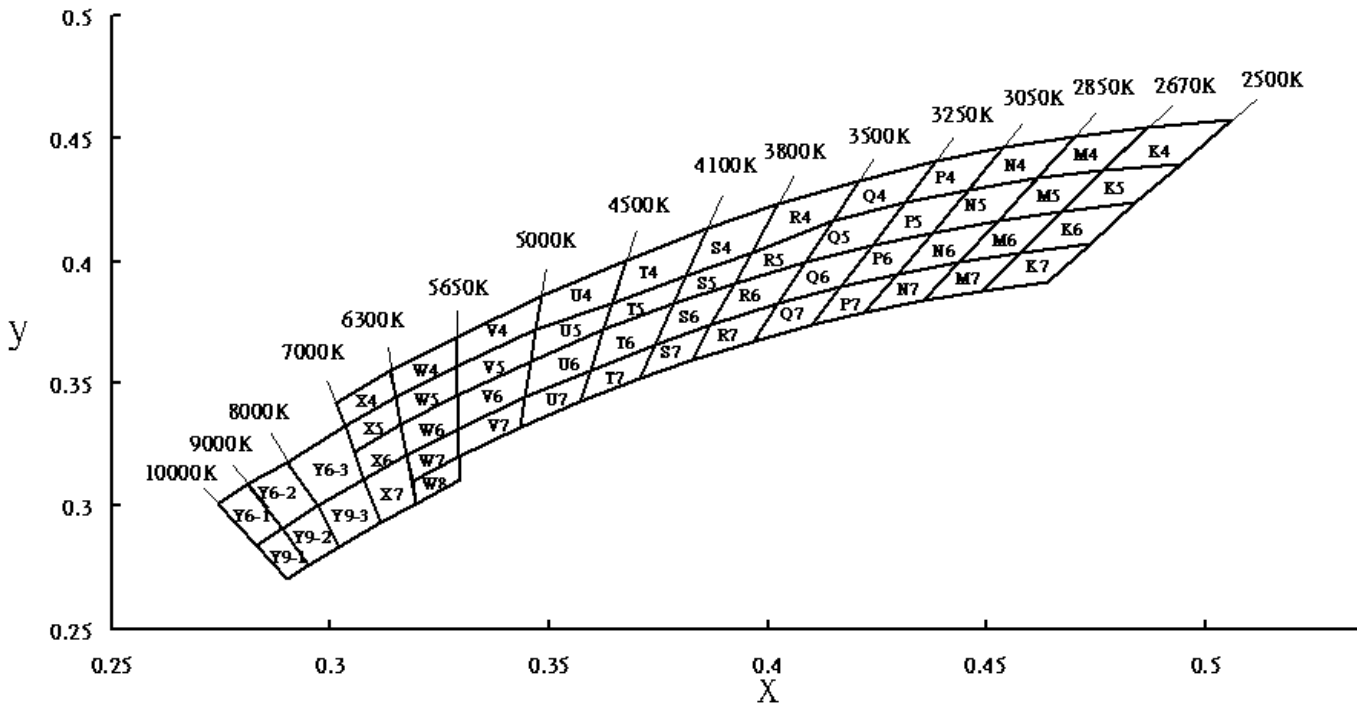

Spectrum Distribution

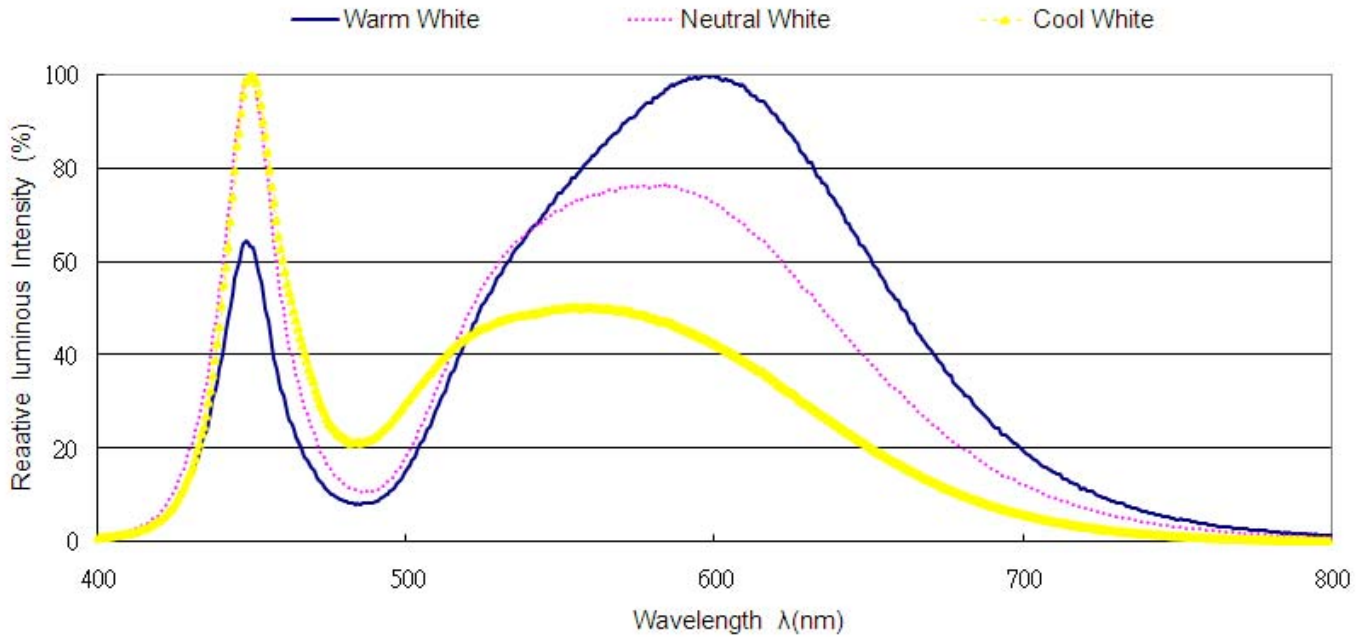

Typical Electro-Optical Characteristics Curves

Fig.1 - Forward Voltage Shift vs. Junction Temperature

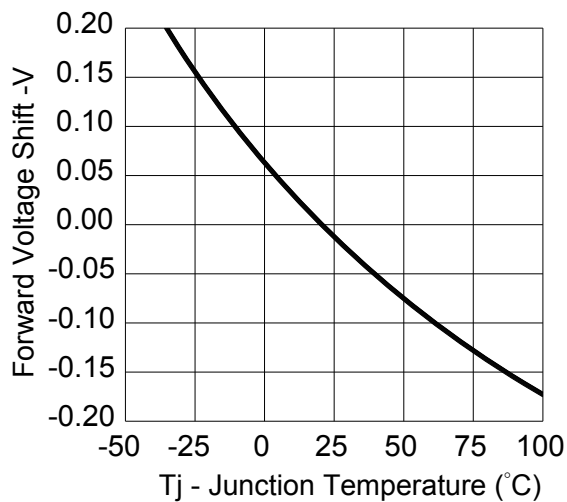
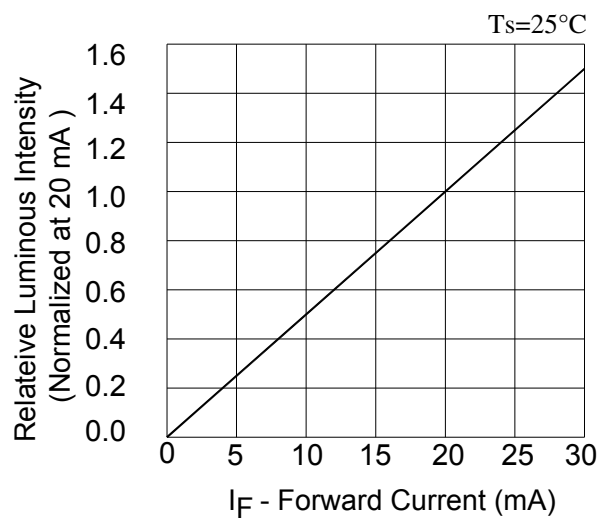

Fig.2 - Relative Luminous Intensity vs. Forward Current



Typical Electro-Optical Characteristics Curves

Fig.3 - Relative Luminous Intensity vs. Junction Temperature

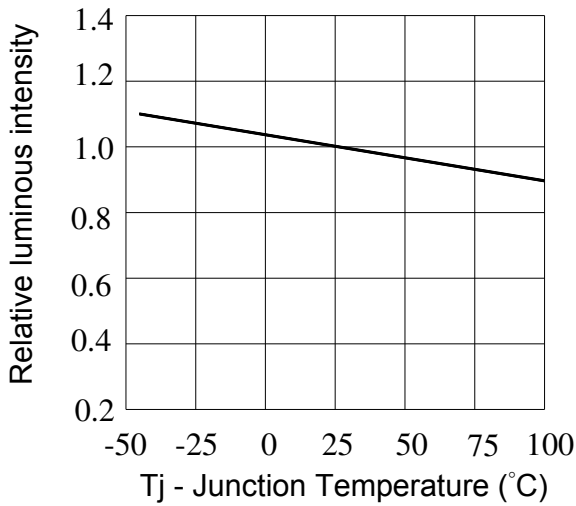

Fig.4 - Forward Current vs. Forward Voltage

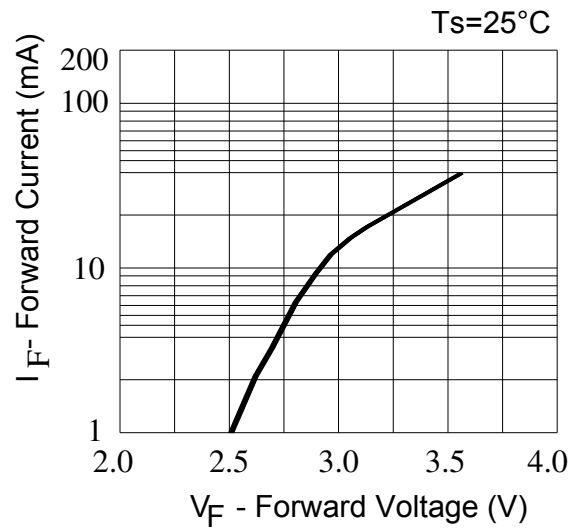

Fig.5 - Max. Driving Forward Current vs. Soldering Temperature

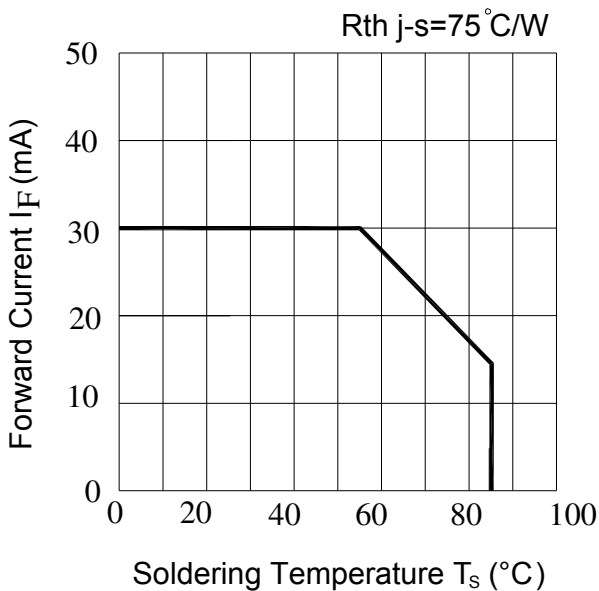
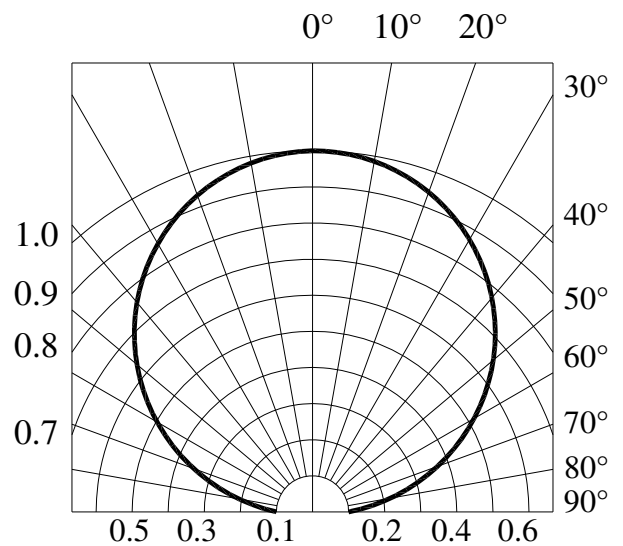
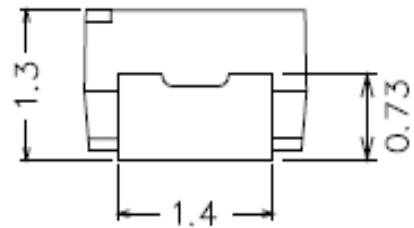
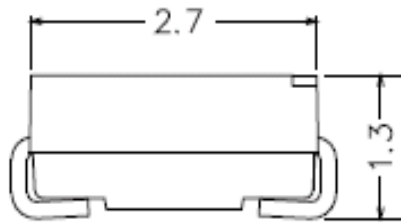
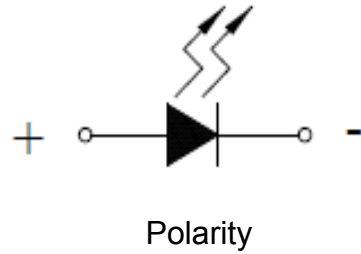
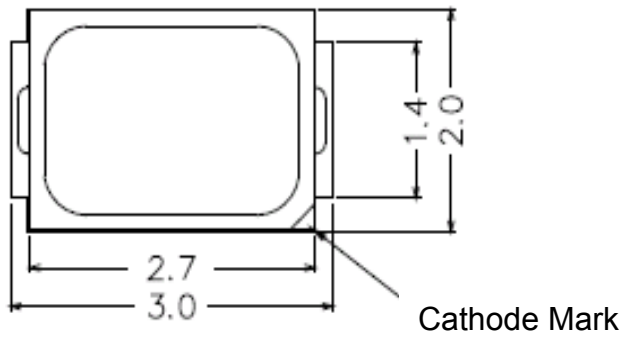

Fig.6 - Radiation Diagram



Package Dimension



Recommended Solder Pad

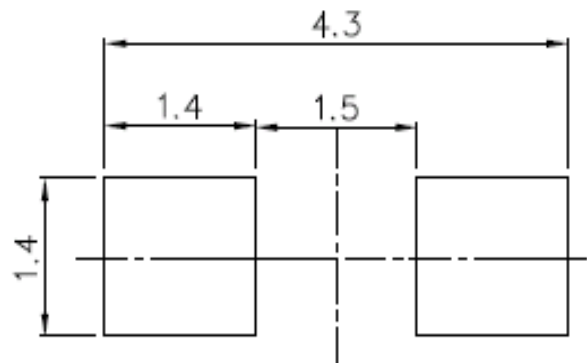
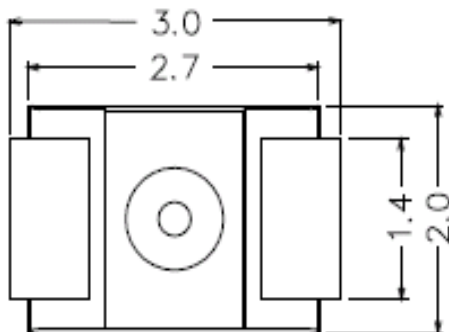

Note:
Tolerance unless mentioned is $\pm 0.2\text{mm}$; Unit = mm

Moisture Resistant Packing Materials

Label Explanation



- CPN: Customer's Product Number
- P/N: Product Number
- QTY: Packing Quantity
- CAT: Luminous Intensity Rank
- HUE: Dom. Wavelength Rank
- REF: Forward Voltage Rank
- LOT No: Lot Number

Reel Dimensions

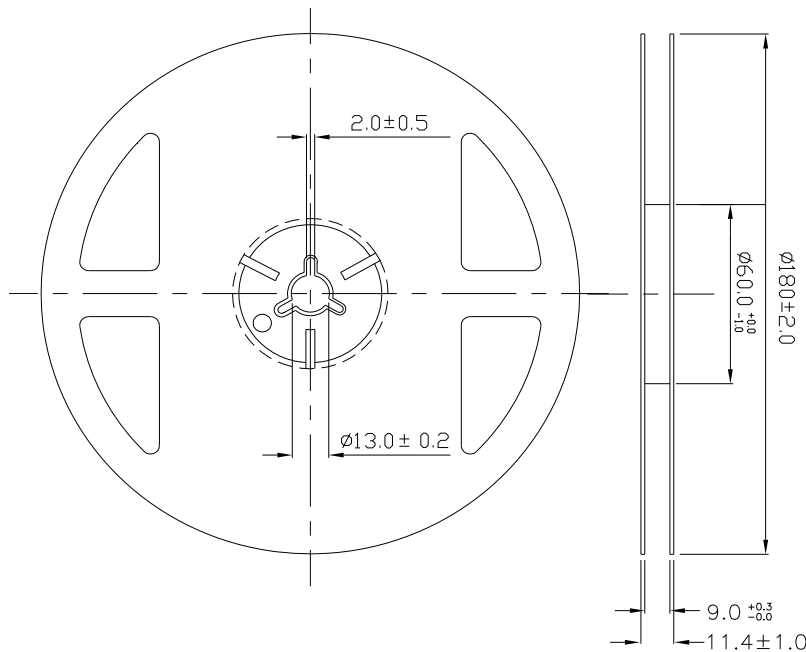

Note:
 Tolerances unless mentioned ± 0.1 mm. Unit = mm

Carrier Tape Dimensions: Loaded Quantity 2000 pcs Per Reel

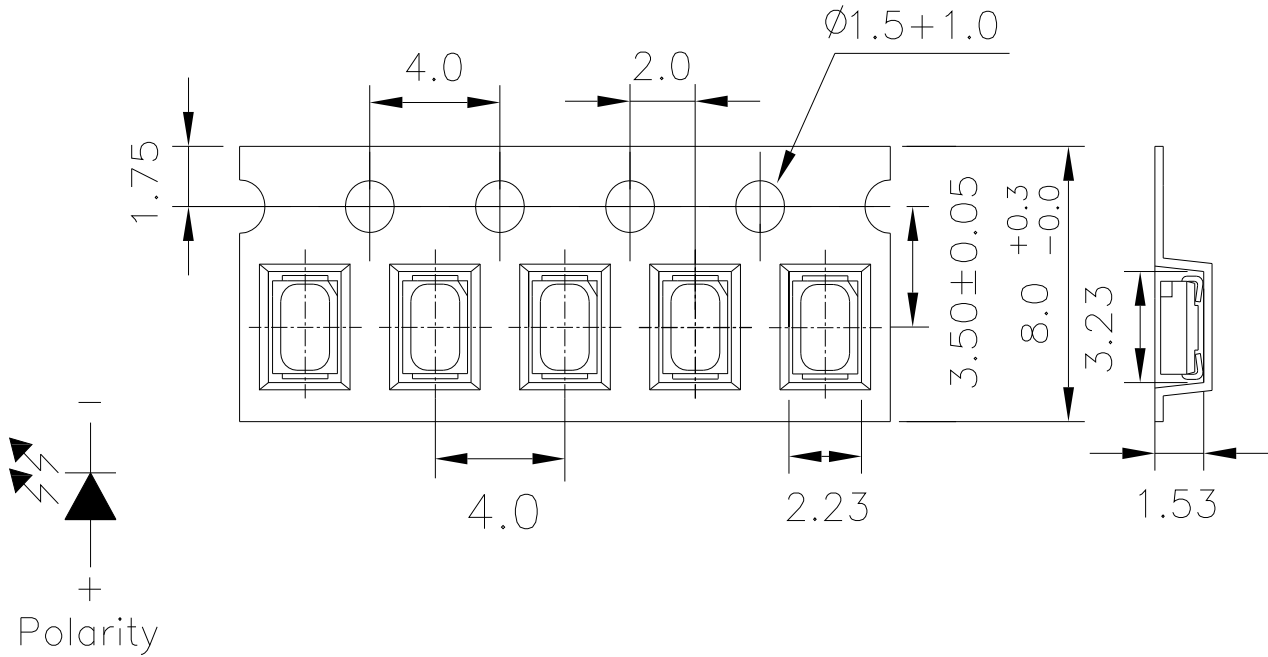

Note:
 Tolerances unless mentioned ± 0.1 mm. Unit = mm

Moisture Resistant Packing Process

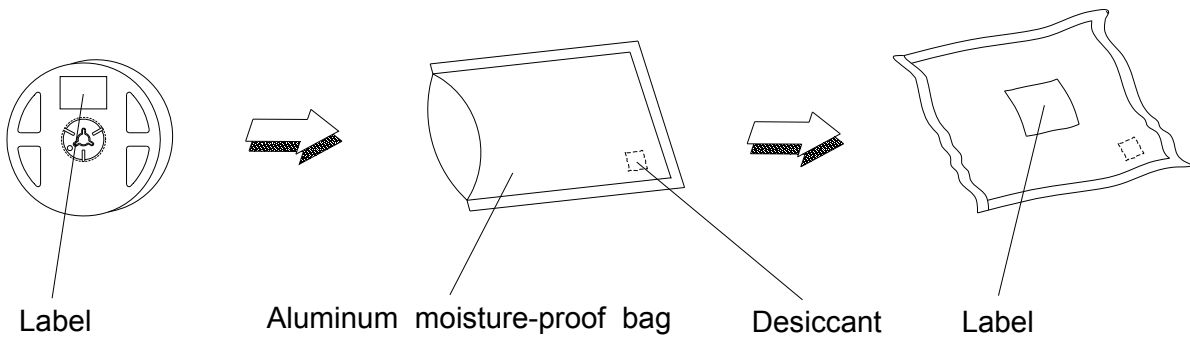

Reliability Test Items and Conditions

The reliability of products shall be satisfied with items listed below.

Confidence level : 90%

LTPD : 10%

No.	Items	Test Condition	Test Hours/Cycles	Sample Size	Ac/Re
1	Reflow Soldering	Temp. : 260°C/10sec.	6 Min.	22 PCS.	0/1
2	Thermal Shock	H : +100°C 5min ∫ 10 sec L : -10°C 5min	200 Cycles	22 PCS.	0/1
3	Temperature Cycle	H : +100°C 15min ∫ 5 min L : -40°C 15min	200 Cycles	22 PCS.	0/1
4	High Temperature/Humidity Reverse Bias	Ta=85°C,85%RH	1000 Hrs.	22 PCS.	0/1
5	High Temperature/Humidity Operation	Ta=85°C,85%RH, I _F = 20 mA	1000 Hrs.	22 PCS.	0/1
6	Low Temperature Storage	Ta=-40°C	1000 Hrs.	22 PCS.	0/1
7	High Temperature Storage	Ta=85°C	1000 Hrs.	22 PCS.	0/1
8	Low Temperature Operation Life	Ta=-40°C, I _F = 30 mA	1000 Hrs.	22 PCS.	0/1
9	High Temperature Operation/ Life#1	Ta=25°C, I _F = 30 mA	1000 Hrs.	22 PCS.	0/1
10	High Temperature Operation/ Life#2	Ta=55°C, I _F =30 mA	1000 Hrs.	22 PCS.	0/1
11	High Temperature Operation/ Life#3	Ta=85°C, I _F = 20 mA	1000 Hrs.	22 PCS.	0/1

Precautions for Use

1. Over-current-proof

Customer must apply resistors for protection; otherwise slight voltage shift will cause big current change (Burn out will happen).

2. Storage

2.1 Do not open moisture proof bag before the products are ready to use.

2.2 Before opening the package: The LEDs should be kept at 30°C or less and 90%RH or less.

2.3 After opening the package: The LED's floor life is 168 Hrs under 30°C or less and 60% RH or less. If unused LEDs remain, it should be stored in moisture proof packages.

2.4 If the moisture absorbent material (silica gel) has faded away or the LEDs have exceeded the storage time, baking treatment should be performed using the following conditions.

Baking treatment: 60±5°C for 24 hours.

3. Soldering Condition

3.1 Pb-free solder temperature profile

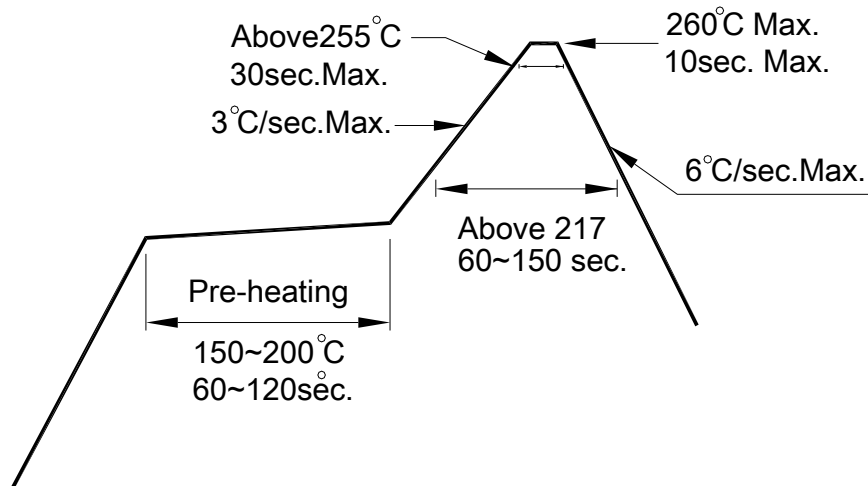

3.2 Reflow soldering should not be done more than two times.

3.3 When soldering, do not put stress on the LEDs during heating.

3.4 After soldering, do not warp the circuit board.

4. Soldering Iron

Each terminal is to go to the tip of soldering iron temperature less than 350°C for 3 seconds within once in less than the soldering iron capacity 25W. Leave two seconds and more intervals, and do soldering of each terminal. Be careful because the damage of the product is often started at the time of the hand solder.

5. Repairing

Repair should not be done after the LEDs have been soldered. When repairing is unavoidable, a double-head soldering iron should be used (as below figure). It should be confirmed beforehand whether the characteristics of the LEDs will or will not be damaged by repairing.

