



Chipsmall Limited consists of a professional team with an average of over 10 year of expertise in the distribution of electronic components. Based in Hongkong, we have already established firm and mutual-benefit business relationships with customers from,Europe,America and south Asia,supplying obsolete and hard-to-find components to meet their specific needs.

With the principle of “Quality Parts,Customers Priority,Honest Operation,and Considerate Service”,our business mainly focus on the distribution of electronic components. Line cards we deal with include Microchip,ALPS,ROHM,Xilinx,Pulse,ON,Everlight and Freescale. Main products comprise IC,Modules,Potentiometer,IC Socket,Relay,Connector.Our parts cover such applications as commercial,industrial, and automotives areas.

We are looking forward to setting up business relationship with you and hope to provide you with the best service and solution. Let us make a better world for our industry!



## Contact us

Tel: +86-755-8981 8866 Fax: +86-755-8427 6832

Email & Skype: info@chipsmall.com Web: www.chipsmall.com

Address: A1208, Overseas Decoration Building, #122 Zhenhua RD., Futian, Shenzhen, China



**3M**

# Cable and Pipe Locating Techniques

for use with 3M™ Dynatel™  
Cable and Pipe Locators



# Table of Contents

## Section 1 The Basics of Cable Locating

1. Introduction .....	7
2. Applying the Signal: The Direct Connect Method .....	8
3. Applying the Signal: The Induction Method .....	9
4. Applying the Signal: The Dyna-Coupler Method .....	10
5. Other Locating Signal Sources .....	10
A. Passive Signals .....	10
B. Power Frequencies .....	11
C. Radio signals .....	11
D. Cable TV Signals .....	11
E. Other Transmitted Signal Sources .....	11
6. Choosing Trace Modes .....	12
7. One Touch Gain adjustment .....	13
8. Locating Techniques .....	14
A. Sweeping .....	14
B. Positioning .....	14
C. Tracing .....	14
D. Identifying Cable By Depth-Current Measurement .....	15
E. Tracing Currents .....	16
9. External DC Power and 5 Watt Output .....	17
A. External DC Power .....	17
B. 5 Watt Output .....	17

## Section 2 Telephone Cable Locating Techniques

1. Introduction .....	9
2. Applying Signal to Telephone Cable: Induction Method .....	9
3. Applying Signal to Telephone Cable: Direct-connect Method .....	20
4. Applying Signal to Telephone Cable: Dyna-Coupler Method .....	21
5. Locating Slack Loops and Butt Splices .....	23
6. Locating Unknown Laterals .....	23
7. Locating Cables from Pedestals .....	24
8. Locating Service Drops .....	25
9. Locating an Open End .....	25
10. Identifying Cables .....	25
11. Pair Identification .....	26
12. Locating Splits .....	27
13. Fiber Optic Locating .....	28
A. Can the Fiber Be Traced? .....	28
B. Applying the Trace Signal .....	29
Attaching at CO or Remote Terminal Office .....	29
Attaching at the Splice Point .....	29
C. Tracing the Fiber Optic Cable .....	30

## Section 3 Power Cable Locating Techniques

1. Introduction .....	31
2. Applying Signal to Power Cables: Direct-connect Method .....	31
A. Applying Signal to the Transformer .....	31
B. Applying Signal at the Meter .....	31
C. Applying Signal to De-Energized Secondaries .....	32
3. Applying Signal to Power Cables: Induction Method .....	32

4. Applying Signal to Power Cables: Dyna-Coupler Method .....	33
A. Applying Signal to Primary Cables .....	33
B. Applying Signal to Secondary Cables .....	34
5. Identifying Slack Loops .....	35
6. Identifying A Cable Open End .....	35
7. Identifying Primary Power Cables .....	36
8. Locating Open Concentric Neutrals .....	37
9. Locating Buried Streetlight Cables .....	38

## **Section 4 CATV Cable Locating Techniques**

1. Introduction .....	39
2. Applying Signal to CATV Cables: Induction Method .....	39
3. Applying Signal to CATV Cables: Direct-Connect Method .....	40
4. Applying Signal to CATV Cables: Dyna-Coupler Method .....	41
5. Locating Cable Slack Loops .....	42
6. Locating Cables from Pedestals .....	42

## **Section 5 Pipe Locating Techniques**

1. Introduction .....	43
2. Applying Signal to Pipe: Induction Method .....	43
3. Applying Signal to Pipe: Direct-connect Method .....	44
A. Direct-connect Method on Tracer Wires .....	45
4. Apply Signal to Pipe: Dyna-Coupler Method .....	45
5. Locating Nonmetallic Pipe .....	46
6. Locating Pipe with Impressed Cathodic Protection .....	47

## **Section 6 Locating Faults**

1. Introduction .....	49
2. Locating Sheath Faults .....	50
A. Locating Sheath Faults Near Pedestals .....	52
B. Locating Sheath Faults Under Pavement .....	53
Perpendicular Method .....	53
Triangulation Method .....	53
Extended Frame Methods .....	54
C. Finding a Fault without Tracing the Cable Path .....	55
D. Multiple Faults .....	56
3. Locating Aerial Faults .....	57
4. Locating Earth Faults Near the Meter Box .....	58
5. Locating Earth Faults in Secondary Cable .....	58

## **Section 7 Locating Active Duct Probes**

1. Introduction .....	59
2. Locating the Active Duct Probe .....	59
3. Determining the Depth of the ADP .....	61
A. Determining ADP Depth with 500A/573A Cable Locators .....	62
4. Locating Blockage or Collapsed Ducts .....	63
5. Locating Sewer Pipe Problems Using a Video Camera .....	63
6. Locating a Flushing Hose Nozzle .....	63

*"Dynatel" is a Trademark of 3M*

This manual has been prepared to provide the most important written instruction material to date for cable locating with 3M's Cable and fault Locating products. It assumes a basic understanding of the commonly used terms in telephone transmission and switching. Whenever this manual is reissued, the reason(s) for reissue will be listed here. Comments concerning the contents or organization of this document, as well as suggestions for improvement are welcomed.

Direct comments to: **3M Telecom Systems Division  
Lab - Technical Communications  
6801 River Place Boulevard  
Austin, Texas 78726-9000**

**For Technical Service call: 800/426 8688  
(outside the USA call 512/984 2575)**

## Glossary

<b>AC</b>	Abbreviation for Alternating Current.
<b>Amplitude</b>	The maximum value of a varying quantity. A signal on a buried cable will have a certain amplitude which may be different from the signal on another buried cable. The receiver electronics can detect and display the difference.
<b>Attenuated</b>	A general term used to denote a decrease in the magnitude of a signal from one point to another.
<b>Audio</b>	A signal which can be heard by the human ear, typically from about 15 Hz to 15 kHz.
<b>Conductive</b>	Property of a material which allows the passage of a signal or current.
<b>Hz</b>	Abbreviation for Hertz. A unit of frequency equaling one cycle per second.
<b>Induction</b>	A method of putting signal on a buried conductor by using a varying current in one circuit (the transmitter) to produce a voltage in another nearby circuit (the buried conductor).
<b>kHz</b>	Abbreviation for kilo-Hertz. Hertz times 1000; Example: 2.7 kHz equals 2700 Hertz.
<b>k ohm</b>	Abbreviation for kilo-Ohms. Ohms times 1000; Example: 2.5 kohms equals 2500 ohms.
<b>LCD</b>	Liquid Crystal Display.
<b>Megohms</b>	Abbreviation for mega-Ohms. Ohms times 1,000,000. Example: 2.5 megohms equals 2,500,000 ohms.
<b>Mode</b>	Method of operation.
<b>Null</b>	A receiver trace mode where the receiver will respond to signal on a buried cable by indicating minimum signal directly over the cable.
<b>Ohmmeter</b>	Device for measuring electrical resistance.
<b>Peak</b>	A receiver trace mode where the receiver will respond to signal on a buried cable by indicating maximum signal directly over the cable.
<b>Resistance</b>	Property of a conductor which determines the current which will flow through it when a particular voltage is applied. Measured in Ohms.
<b>RMS</b>	Abbreviation for root-mean-square. Used to designate the measurement of a voltmeter when measuring 60 Hz. Example: 110 volts RMS.
<b>Secondary</b>	A cable transmitting approximately 600 volts or less.
<b>Triangulate</b>	A method of finding the location of a point by taking observations at two of the corners of a triangle. The point where the two observations cross is the third corner of the triangle and the target location.
<b>Voltmeter</b>	Device for measuring electrical potential difference.



# Section 1 The Basics of Cable Locating

## 1. Introduction

- 1.1 Cable locating is not an exact science, yet. To do a good job, you must know your equipment, and use your intuition and good judgment. Certain techniques can alert you to potential problems and make the difference between a good locate and a bad one. In this manual, we discuss the basics of locating buried cable or pipe by using a Transmitter to apply a signal to the conductor, and tracing the conductor's path using a Receiver.
- 1.2 There are three methods of applying signal with a 3M™ Dynatel™ Transmitter:
- Direct connect method
  - Induction method
  - Dyna-Coupler method
- 1.3 With any method of applying signal, frequency choice is important to get the “most” signal on the cable. Any signal applied to an insulated, buried cable or pipe leaks off to ground; as it gets farther away from the transmitter, the signal gets weaker and finally disappears. How fast it leaks off is determined by:
- Cable diameter,
  - wet or dry soil conditions, and
  - signal frequency.

Since these conditions vary, the Dynatel Transmitters offer more than one frequency choice:

**Low (<10 kHz):** These frequencies usually provide the most accurate locate in congested areas (the lower the frequency, the better). They are best for tracing over long distances and do not couple easily to other buried cables. These frequencies are generally too low to be used with the Dyna-Coupler or the induction mode and so the direct-connect method should be used (direct-connect is the preferred method).

**Medium (30 kHz - 90 kHz):** Medium frequency allows the use of the Dyna-Coupler and the induction mode. Although it will couple to other nearby cables, medium frequency does not do so as strongly as high frequency. Medium frequency travels less far than low frequency but farther than the high frequency. It is best when the Dyna-Coupler or the induction mode is used (when the direct-connect method cannot be used) and the tracing distance is one mile or less.

**High (130 kHz - 350 kHz):** High frequency attenuates rapidly and so is intended for shorter runs. High frequency will couple strongly to other nearby cables. It will work best with the Dyna-Coupler and the induction mode. High frequency is best for sweeping a large area to locate all buried cables. If the receive signal is weak at the beginning of the trace, first try high power, then a higher frequency.



## 2. Applying the Signal: The Direct-connect Method

- 2.1 Connecting directly to the cable or pipe you want to trace (power cables only if they can be de-energized) is the most accurate method of cable locating. Connecting the Transmitter directly isolates the signal to one cable.

**Danger!** *Voltage greater than 240 volts will damage equipment and cause personal injury and death. Make all direct test connections before turning on the Transmitter. Then activate the Transmitter in the Ohms mode and check the display for voltage readings. Follow standard procedures for reducing the voltage.*

- 2.2 Set the Transmitter frequency to a lower frequency (where applicable); low frequencies do not couple to other grounded cables as easily as higher frequencies, and they travel further down the cable.
- 2.3 There are several methods for direct-connecting the transmitter, depending on your application. These may include applying signal to a telephone or CATV pedestal, a power transformer or meter, or directly to the cable or pipe. You can find detailed instructions for your application in later sections of this manual.

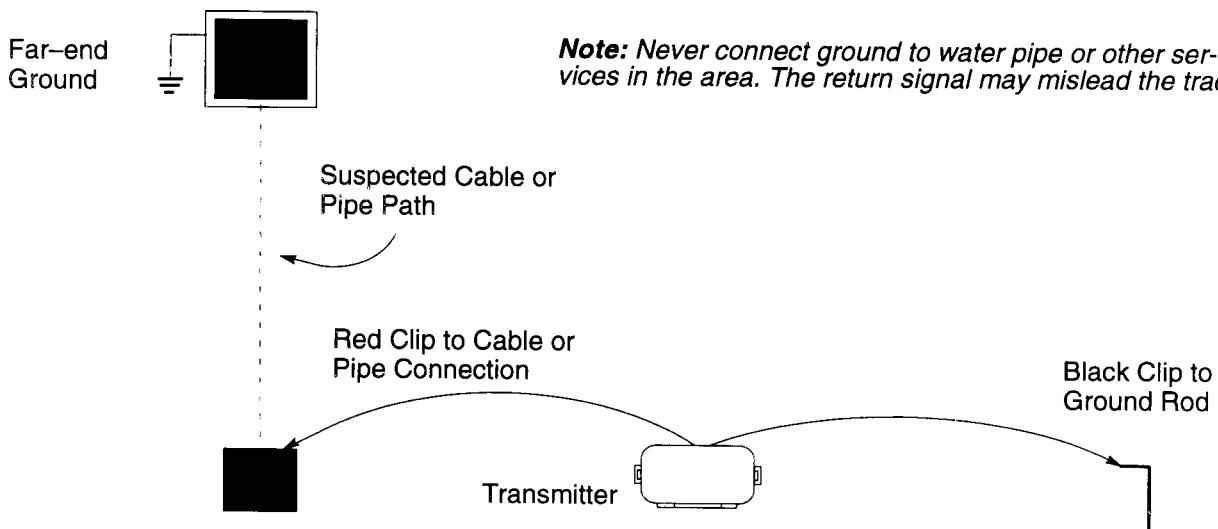

### A Few Important Points About Grounding

- 2.4 Grounding can “make or break” a locate when you are using the direct-connect method. The Transmitter connects electrically to the cable or pipe to be located and sends signal current through it. The signal goes to ground at the far-end, and returns to the Transmitter through the ground rod. If the conductor is not well grounded, or if the Transmitter connection to the ground rod is poor, the signal will also be poor and not detectable. The better the ground, the stronger the signal.
- 2.5 Place the Transmitter ground rod as far from the far-end ground and as far from the trace path as possible. In general, this means placing the ground rod at a ninety-degree angle to the suspected path, as shown above. If necessary, you can extend the ground lead with any insulated wire.

### 3. Applying the Signal: The Induction Method

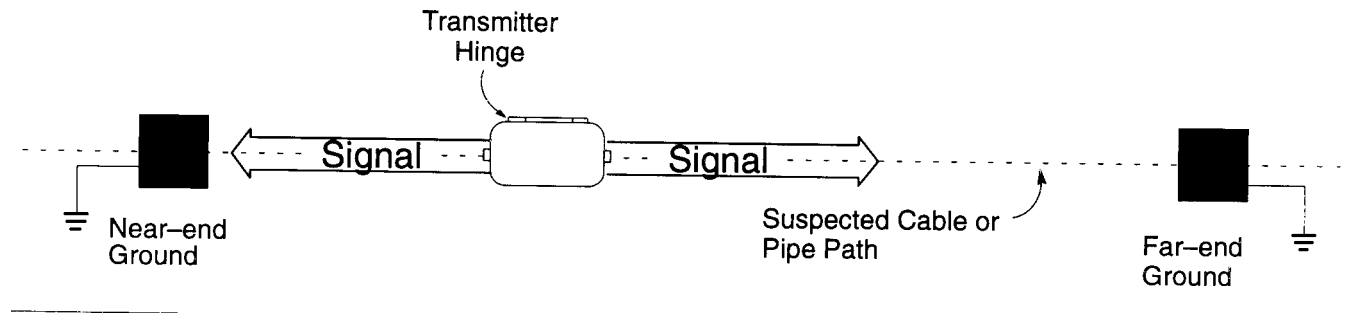

- 3.1 The simplest way to put signal on a buried cable or pipe is with induction, where you merely set the Transmitter on the ground directly over the cable and turn the Transmitter on. The Transmitter induces signal current (tone) into any parallel conductor within range.
  - 3.2 It is important to place the unit directly over the cable, with the hinge parallel to the cable path, as shown above. The signal drops off rapidly if you place the Transmitter even 5 or 10 feet to either side of the path.
- Note:** *In congested situations where services such as gas or water pipes, cable TV, and lawn-watering control circuits are all buried nearby, you should not use the induction method to apply signal. The induction mode applies signal to all nearby conductors and confuses the trace.*
- 3.3 The strength of the induced signal depends on three things: the Transmitter frequency, how well the conductor is grounded, and how deep the conductor is buried.
  - 3.4 From the Transmitter, a higher frequency travels farther than lower frequencies and couples to nearby conductors (such as the cable or pipe to be traced). When using the Induction method, set the Transmitter frequency to 33 kHz or higher frequency. Keep in mind that higher frequencies and the high output level setting also put signal on conductors other than the one you are tracing. Also, the Receiver can pick up signal from the Transmitter up to about 50 feet away, even if no cable exists between them. For best results, keep the Receiver away from the Transmitter by at least that distance.
  - 3.5 The conductor must be well-grounded at both ends to produce a good locate. In all methods, the better the ground to the conductor, the stronger the signal.
  - 3.6 You can find detailed instructions for using the Induction method in your application in later sections of this manual.

## 4. Applying the Signal: The Dyna-Coupler Method

**Note:** The coupler jaws must fully close for signal transmission.

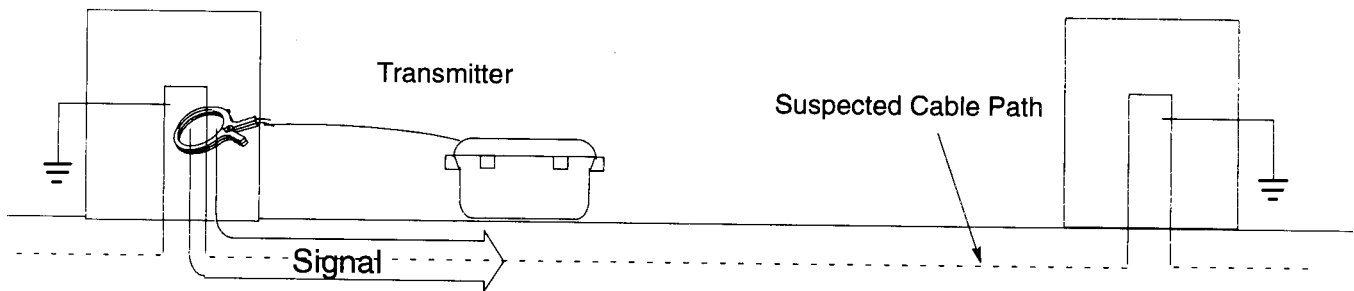

- 4.1 The easiest way to put signal on a cable is with the Dyna-Coupler. When its jaws close around a cable or pipe, the Dyna-Coupler couples the Transmitter signal onto it. As with the other methods, the cable or pipe must be grounded to form a complete circuit path for the signal to follow.
- 4.2 When you apply the Dyna-Coupler between grounds, signal will be on the section between the grounds.
- 4.3 You can find detailed instructions for using the Dyna-Coupler in your application in later sections of this manual.

## 5. Other Locating Signal Sources

### A. Passive Signals

- 5.1 Passive signals are naturally present on many conductors and allow you to locate cables without using the Transmitter. For example, power cables carry 50 or 60 Hz currents. Less obvious are low frequency currents resulting from local broadcast radio transmissions that penetrate the earth and flow along metallic cables.
- 5.2 Passive signals let you locate conductors but not identify them because the same signals may appear on all conductors. Their value is in enabling buried conductors to be detected and avoided using only the Receiver. Be aware that all passive signals may change without notice.
- 5.3 When you plan to excavate to a conductor that has been located and identified with an active signal, you should give the area a passive sweep to check for other nearby lines that are at risk during the excavation. Lines that you locate during a passive sweep can then be traced and identified with an active signal.

## **B Power Frequencies**

- 5.4 An energized cable carrying AC power produces a 50 or 60 Hz signal. Although these are relatively low frequencies, they can still couple into other conductors buried nearby. You can detect the conductor because of the signal, but identification is impossible. The signal could be coming from a power cable, a nearby pipe, or concrete reinforcing bars. However, the knowledge that these conductors exist is useful.
- 5.5 Most energized power cables are easy to detect but sometimes power cables are designed to minimize the strength of radiated signals by twisting the wires so that the 'go' and 'return' current fields cancel each other. These cables are difficult to detect. All Dynatel Receivers detect the 9<sup>th</sup> harmonic of the 50 or 60 Hz frequency (450 or 540 Hz). The 9<sup>th</sup> harmonic works especially well with three-phase cables. The fundamental frequency normally cancels in a three-phase installation but the 9<sup>th</sup> harmonic reinforces, generating a stronger signal to trace. Some Receivers detect the 5<sup>th</sup> harmonic as well as the 9<sup>th</sup>. The 9<sup>th</sup> harmonic is best for most passive power frequency locating, but if the signal is weak or intermittent, the 5<sup>th</sup> harmonic may be able to help. These harmonics are displayed as low (5<sup>th</sup>) or high (9<sup>th</sup>). For 60 Hz the selection on the display would read L60 or H60 and for 50 Hz it would read L50 or H50.
- 5.6 Some Receivers have a selection for the second harmonic of the 50 or 60 Hz frequency (100 or 120 Hz). This passive power frequency is useful for tracing a conductor carrying a rectified AC signal. Such signals are used in impressed cathodic protection systems for pipe. The display will read either 100 or 120 when this frequency is selected.

## **C Radio Signals**

- 5.7 Low frequency radio signals from local broadcast transmitters will cause currents to flow in buried conductors. These signals are then reradiated from the conductor and can be detected by the Receiver. The Receiver frequency should be set to the LF selection (available on E version Receivers only).

## **D Cable TV Signals**

- 5.8 The second harmonic of the NTSC television horizontal scan frequency is detectable by the Receiver at 31.5 kHz. This frequency is coupled onto the cable by the yoke coils of an operating television receiver. The signal is strongest near the TV receiver so it is useful in finding CATV drops. The display of the locator Receiver reads 31 kHz when this frequency is selected.

## **E Other Transmitted Signal Sources**

- 5.9 Some long distance copper or fiber optic cable systems have limited access and may have permanently installed transmitters at strategic locations for use in tracing the cable. If they can transmit 577 Hz, 512 Hz or 560 Hz, the signal can be detected by the Receiver.

## 6. Choosing Trace Modes

- 6.1 In most cases, you would choose PEAK mode, but for fast or difficult tracing other modes can be handy. The following is a brief description of each trace mode:

**PEAK:** In this mode, the Receiver speaker volume increases to a maximum as the antenna crosses the cable. It diminishes as the antenna moves away from the cable path. Simultaneously, the bar graph fills from both sides toward the middle as the 'peak' zone is crossed then opens as the midpoint is passed. The numeric strength indicator also increases to a maximum. Peak mode is useful when tracing changes in cable direction because speaker volume falls off rapidly if the antenna handle is not in line with the cable path. In such a case, a sharp turn or bend in the path is indicated.

**PEAK with EXPANDER:** The expander is used with peak mode to sharpen or enhance the audio response. The effect is to only allow audio response directly over the cable. If the antenna is moved rapidly, the receiver appears to beep as the antenna crosses the cable path. The expander is useful when you wish to rapidly trace a long straight stretch of buried cable and also to precisely trace a turn or change in direction.

**NULL:** In this mode, the signal is a minimum directly over the cable and is maximum on either side of the cable. The speaker volume and numeric display signal strength correspond to the signal being received. Some receivers have two bar graph response modes. Refer to your Operators Manual for more information.

**DIFFERENTIAL:** In this mode, the Receiver provides an indication of the relative position of the cable to the Receiver by displaying right or left arrows (the arrow points toward the cable). The bar graph increases to a maximum as the Receiver antenna is moved directly over the cable path. Speaker response is a high warbling tone to the right of the cable path, a low warbling tone to the left, and a solid tone directly over the cable.

**SPECIAL PEAK:** This mode will increase the signal sensitivity of the Receiver when the signal is too weak for normal tracing. Use special attention when using this mode because it is more susceptible to congestion than the normal peak mode.

**Note:** While tracing cables, keep the Receiver handle in line with the suspected cable path.

## 7. One Touch Gain Adjust

- 7.1 It's Simple... No Guessing... No Trial & Error... No multiple presses needed... When using Peak or Null Tracing modes, just press the Receiver Gain-key "once" to automatically adjust the gain and set the bar graph reference point.
- 7.2 Always adjust the Receiver gain only when you are over the target cable and in either Peak or Null mode. If too much signal is indicated by a completely closed bar graph, press the Gain Adjust key once to automatically adjust the gain and set the bar graph reference point. When the bar graph is completely open, it indicates a weak signal. Press the Gain Adjust key once and the gain will be adjusted and a new bar graph reference point will be set.
- 7.3 As you trace cables away from the transmitter, the signal becomes weaker and it is necessary to readjust the gain. Press the Gain Adjust key once and recheck the signal before continuing.

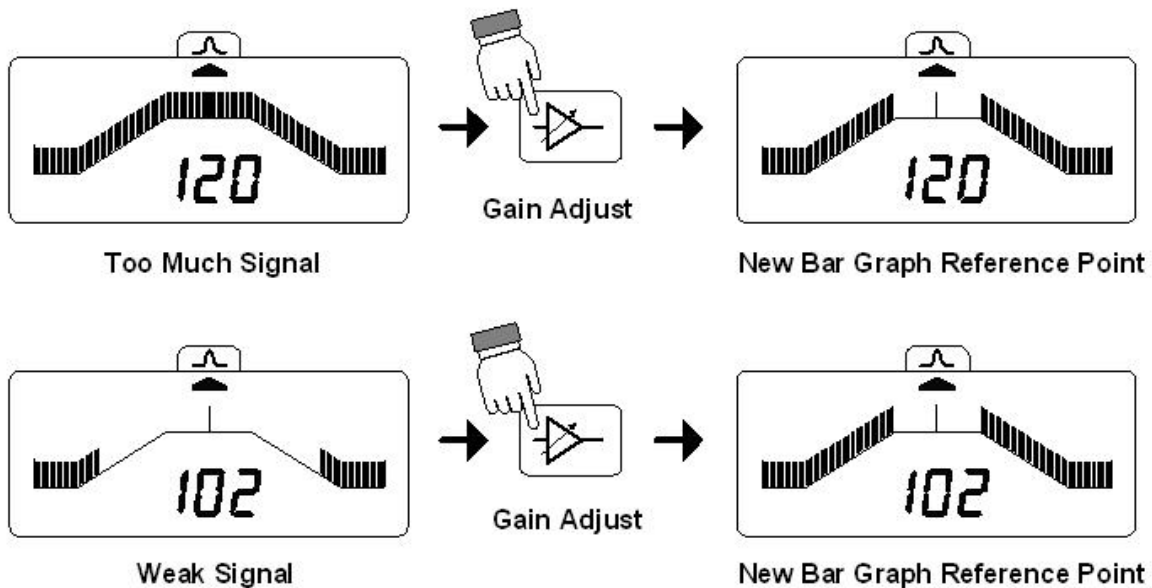

## 8. Locating Techniques

### A. Sweeping

- 8.1 Sweeping an area allows you to locate all buried cable in the area. Use the Induction method to apply the Transmitter signal. Use the highest frequency available so that all cables in the area carry signal. Walk in a grid pattern over the area as shown, and cover the area from two directions. Walk the grid again using the Power mode. Stop the sweep when there is a response. Locate the position of the cable then trace it until you are out of the area, marking the path. After tracing the cable, resume the sweep.

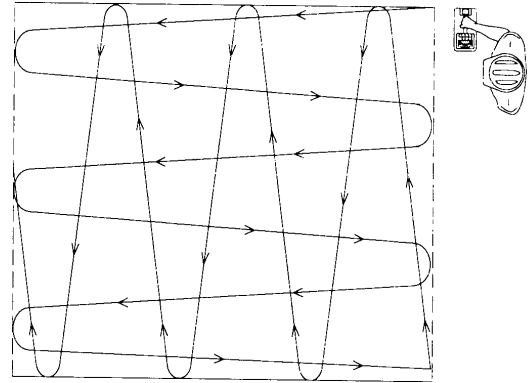

### B. Positioning

- 8.2 Positioning is a technique used to quickly find the trace path of a buried cable. The technique can save time when the signal is lost while tracing. Use this technique rather than starting over.
- 8.3 Place the Receiver in the differential mode. Place the antenna on the ground and rotate the Receiver around the antenna as if it were a pivot. Watch the left-right arrows on the display. There is a point where a small counterclockwise rotation lights the right-arrow and a small clockwise rotation lights the left arrow. At this point, note the direction of a line through the Receiver handle. Turn the Receiver 90 degrees from this line (right or left makes no difference). One of the direction arrows is visible. Side step in the direction of the arrow until the Receiver indicates that the cable has been crossed.

### C. Tracing

- 8.4 To get the most accurate results when tracing a cable, signal should be isolated to the individual cable. This means using either the direct-connect or Dyna-Coupler methods of applying signal. If surface access is not possible, then use the induction method. Trace the cable at a slow walk while moving the Receiver in a side-to-side motion. Periodically mark the path.
- 8.5 As tracing proceeds, remember that the most powerful signal is near the Transmitter. As the Receiver gets farther away from the Transmitter the signal strength drops off. It is necessary to readjust the gain periodically, to be sure there is adequate signal for the Receiver to operate. Press the GAIN ADJUST key when the bar graph is no longer visible (too little signal) or when the bar graph is closed (too much signal).

## D. Identifying a Cable by Depth-Current Measurement

- 8.6 When you apply signal to a cable (using the direct-connect or Dyna-Coupler methods) the signal can travel on all the cables which share ground with your target cable. This can cause trouble with the locate, as a shallow cable with a weak signal can give as good a response as a deep cable with a strong signal.
- 8.7 In the illustration below, transmitter signal was applied to cable 'B' and a strong signal current travels its length. Cable 'A' shares the same ground as cable 'B' and now carries the same signal, but the signal current is greatly reduced. Since cable 'A' is shallow (about one foot), it gives a strong signal response even though the deeper cable 'B' carries more signal current. To identify which response comes from cable 'B', find the strongest response over each cable and press the depth key. During depth measurements, the auxiliary numeric indicator indicates the strength of the signal current in the cable. The cable with the most current is the target cable. Don't forget to also check the depth readout. Most CATV cables are buried one foot or less. Telephone cables are buried at three feet. Power cables and gas pipes are at four feet.

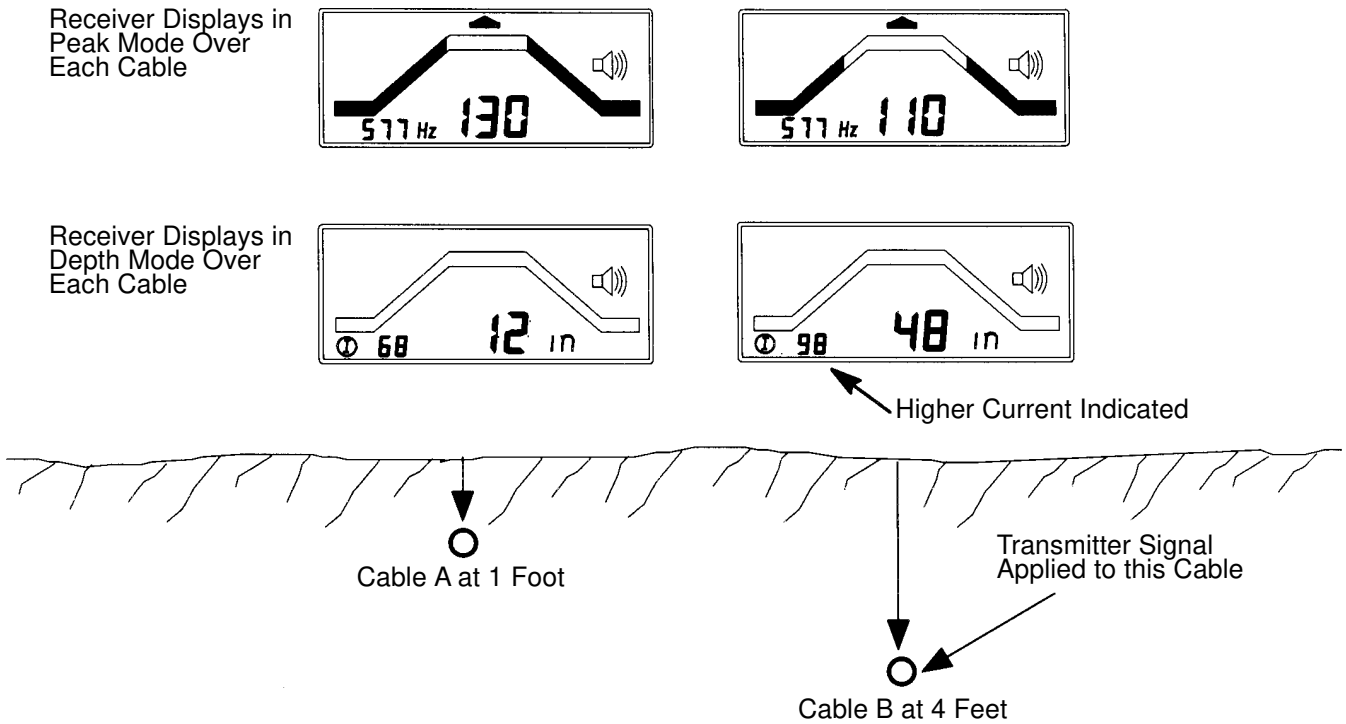



- 8.8 Imagine this problem: You know you have two cables with the same signal and just when you think you've got the target cable identified, the two cables cross. Again, you can use the depth-current measurement to identify the target cable. When cables 'A' and 'B' cross, they change depth. This is not unusual and is often the case. Since the Receiver's signal response varies with depth, it may be difficult to identify the cables using signal level alone. However, the signal current in the cables will not change, and you can compare the bar graph reading in depth mode to identify the cables.

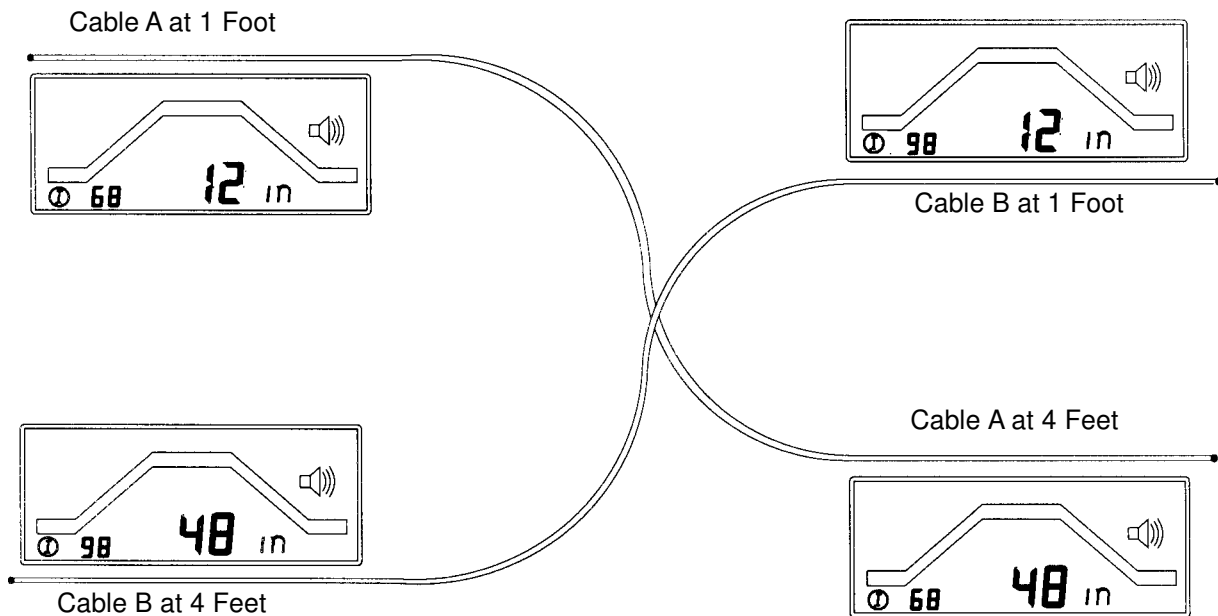

## E Tracing Currents

- 8.9 Some Transmitters and Receivers will display cable current. These current indications can be used to select a trace frequency, identify the correct cable, or troubleshoot the set up.
- 8.10 When using the direct connect method, if the Transmitter output current number in the display reads LO, or is a number less than 50, it indicates that the tracing signal is too weak. A number higher than 70 represents a strong tracing signal. Maximize the current number by changing the frequency. Every ten units on the current display represents a factor of two in current magnitude in the cable.
- 8.11 When the Receiver is used to find the cable near the Transmitter connection point, the current number displayed in the Receiver should correspond (within  $\pm 5$  points) to the Transmitter number. You must be over the correct cable, and the signal must not be split between two or more cables.
- 8.12 When the Transmitter signal is applied using the Dyna-Coupler, the Transmitter display indicates the current in the coupler and not in the cable. In order to get a measure of the cable current, point the Receiver at the exposed cable about two feet from the Dyna-Coupler. This will be the current number that should be used to identify the correct cable. In general, when the Transmitter is set up to apply more current on the target cable than any other cable, the target cable can be easily identified because the Receiver current reading will be highest.
- 8.13 Since some of the signal in a cable bleeds into the earth, it is expected that the Receiver current indication along the cable will decrease gradually as you move away from the Transmitter. This effect is more pronounced at higher frequencies.

## **9. External DC Power and 5 Watt Output**

### **A External DC Power**

- 9.1 Dynatel Transmitters with option A can be operated from an external 12VDC source as well as its internal batteries. A cigarette lighter adapter-cable is supplied to connect the DC power from a vehicle's battery to the Transmitter's external power connector located next to the output connector. This lets you save the internal batteries by using an external power source or continue operating when the internal batteries are discharged. The internal batteries do *not* recharge when an external DC voltage is applied to the Transmitter's external power connector.

### **B 5 Watt output**

- 9.2 Dynatel Transmitters with option A are capable of 5-watt output as well as the normal 3-watt output. An external DC source is required for 5-watt output. Use the higher output when a very long trace is required. The higher output should also be used on any continuously grounded cables such as lead shielded cables or non-jacketed concentric neutral cables.



# Section 2 Telephone Cable Locating Techniques

## 1. Introduction

- 1.1 Read Section One of this manual to learn more general information about each of the following signal application methods. The following paragraphs provide specific instruction on applying signal for telephone cable locating.

## 2. Applying Signal to Telephone Cable: Induction Method

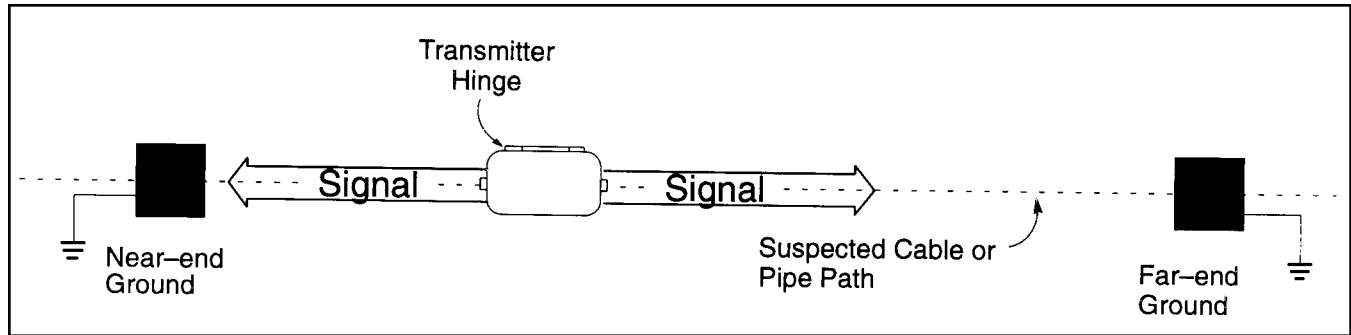

- 2.1 The Induction method broadcasts signal into an area. No access to the cable is necessary. Use this only when there are no other buried conductors present, or when locating all conductive buried services in a general area.
- 2.2 Place the Transmitter on the ground over the cable to be located. The Transmitter hinge should be in line with the cable path, as shown above. Be certain that the Transmitter is directly over the cable to be located.
- 2.3 Turn the Transmitter on and choose 33 kHz signal or higher.
- 2.4 Use the Receiver to test the signal level by placing the Receiver 50 feet away from the Transmitter on the ground near the cable. Move the Transmitter back and forth across the path. Listen for the strongest signal from the Receiver. If the Receiver has trouble picking up the cable path, return to the Transmitter and switch to a higher frequency. If the higher Transmitter frequency will not give satisfactory Receiver response, then boost the Transmitter output as instructed in the unit's Operating Instructions. You can also increase the response by placing the Transmitter on the located position over the cable (50 feet away from the Transmitter's previous position).

### 3. Applying Signal to Telephone Cable: Direct Connect Method

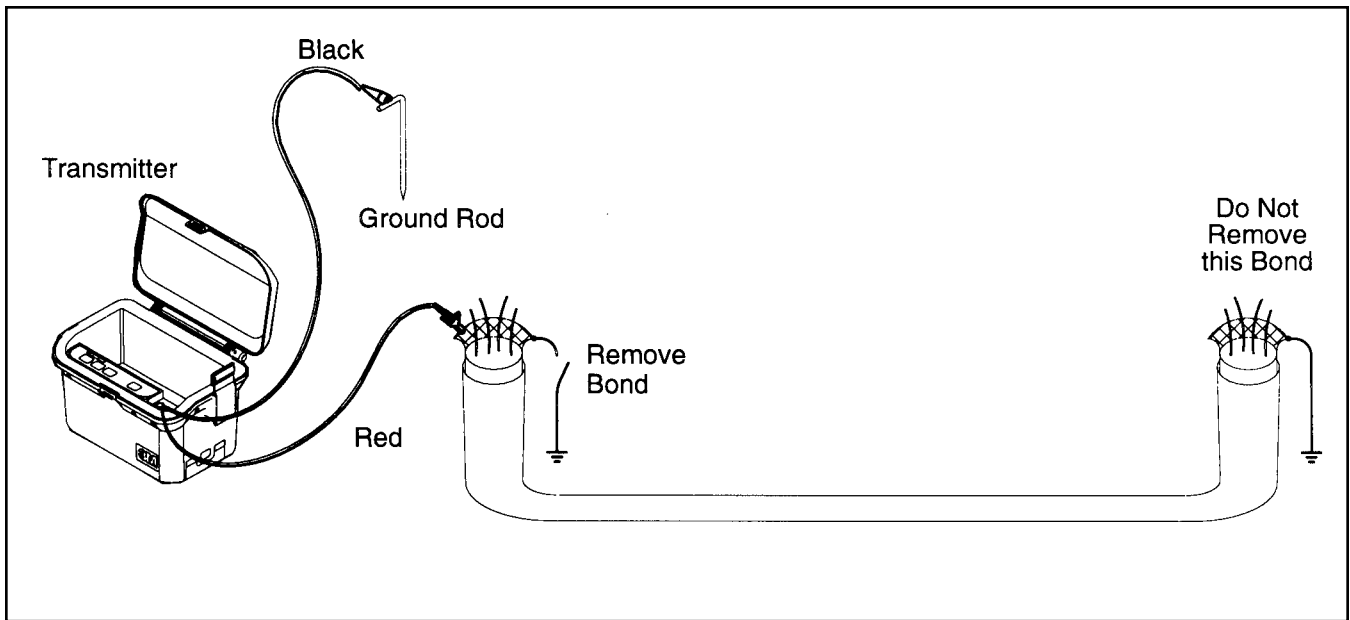

- 3.1 The direct-connect method requires access to the cable shield. Disconnect the cable at the near-end where the Transmitter is connected. Do not disconnect at the far-end since this supplies a far-end ground.
- 3.2 Connect the red lead of the Transmitter to the cable shield and the black lead to the ground rod.

**Warning!** Potential for electrical shock exists when handling connecting cables while the Transmitter is in the Fault or Tone modes. Turn the transmitter off before handling connecting cables.

- 3.3 Place the ground rod as far away from the cable path as possible (90 degrees from the suspected cable path). Never ground to water pipe or other services in the area. The returning signal on these services may mislead the trace.
- 3.4 Remove the ground bonding at the near-end. The far-end should have a good ground. Turn the Transmitter on and choose the 577 Hz frequency to get greater signal distance down the cable.

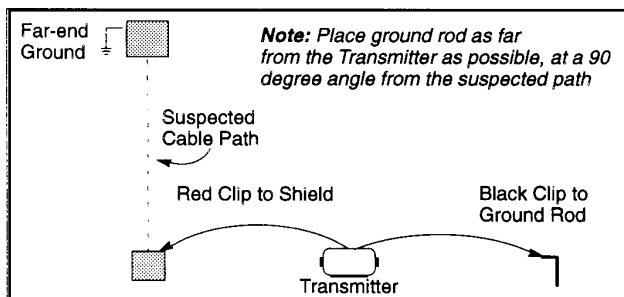

#### 4. Applying Signal to Telephone Cable: Dyna-Coupler Method

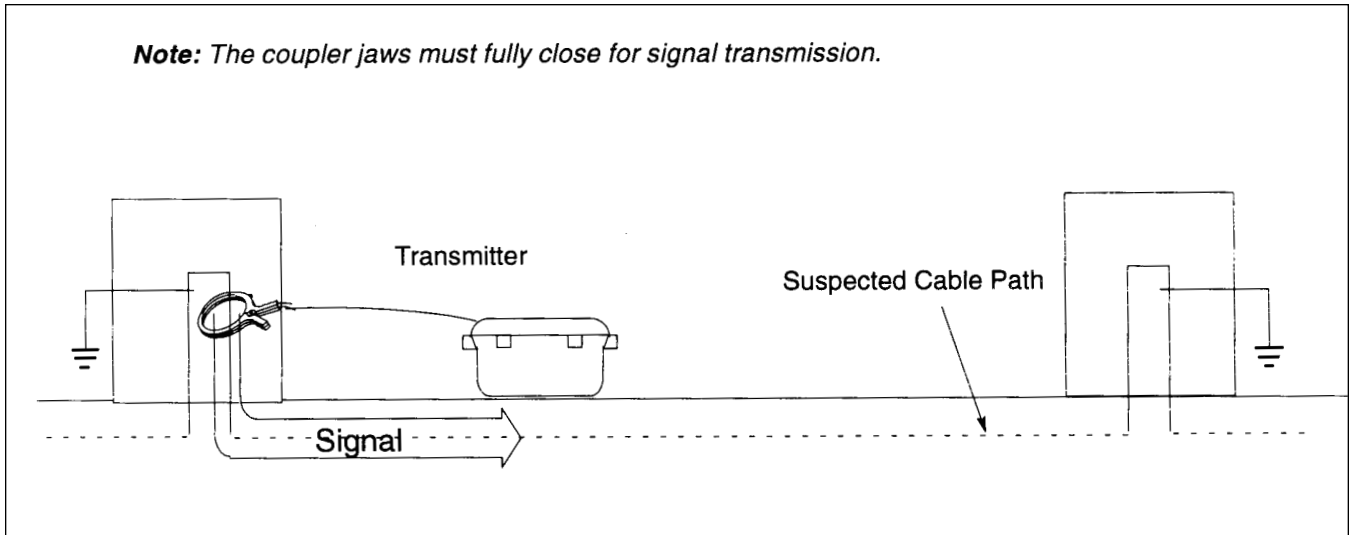

4.1 The Dyna-Coupler puts signal selectively on a cable by clamping around it. This eliminates the need to disconnect the cable. Do not use the Dyna-Coupler on a cable that has the shield ungrounded at both ends.

4.2 Place the Dyna-Coupler on the cable between the ground bonding and the point where the cable enters the earth as shown (A). Note that if you place the Dyna-Coupler above the bond, the signal travels to ground, and not onto the cable.

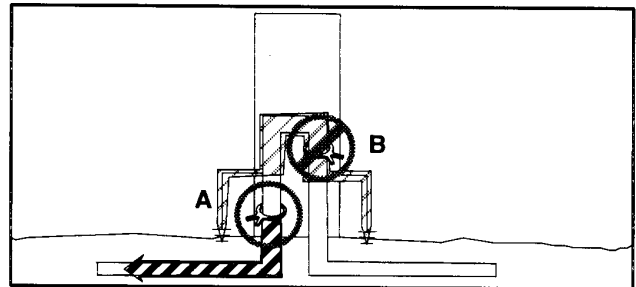

4.3 On short cables, such as service drops, do not use the Dyna-Coupler on an ungrounded end (C). It works better on the grounded end (D). If possible, ground end (C); if not, be sure to use the highest frequency possible.

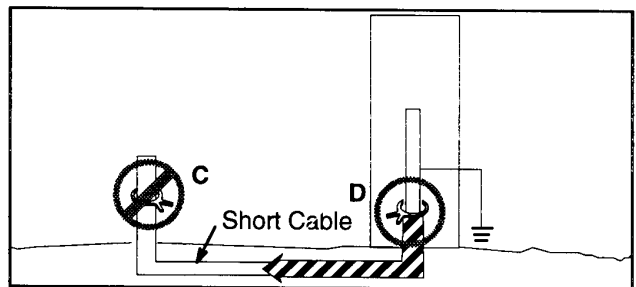

*Note:* Always use the high output level when using the coupler.

- 4.4 If the cable is long, remove the bonding and signal goes both ways as shown.

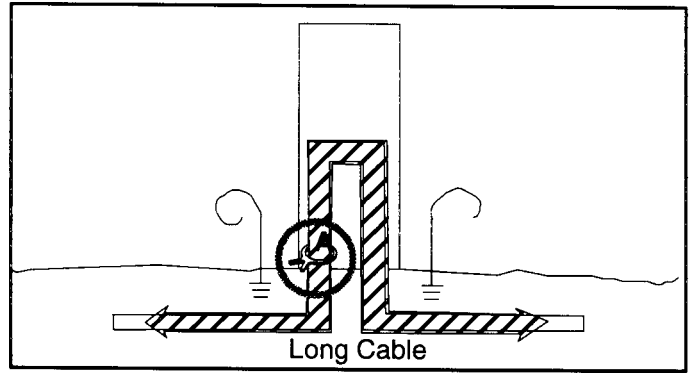

- 4.5 Clamping the Dyna-Coupler to a cable with drop lines or laterals puts full signal on the cable until the junction point. The signal may split evenly at the lateral as shown. When tracing, the speaker volume and signal level indication drops when the Receiver passes the junction. This is an easy way to find laterals.

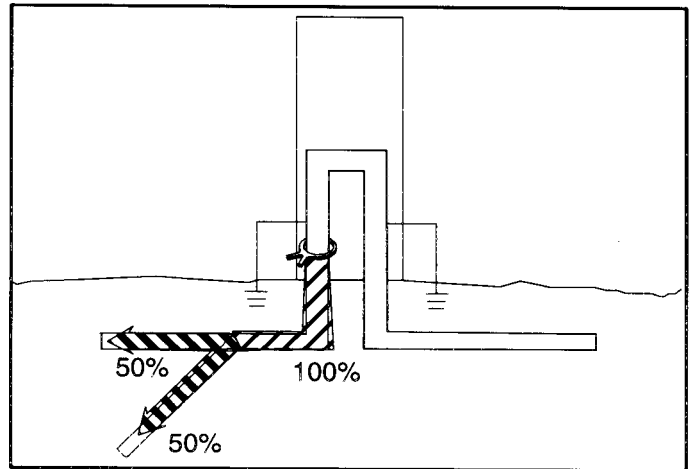

- 4.6 Several cables grounded at a common point present no problem for the Dyna-Coupler method. Even though signal is coupled into each cable, the cable with the Dyna-Coupler is clearly identifiable because it has the strongest signal.

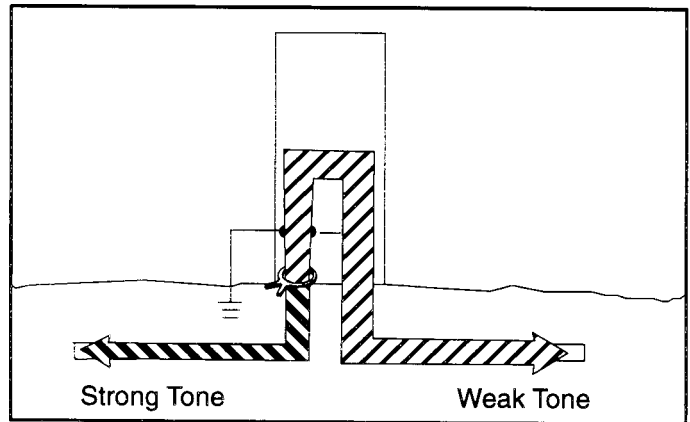

## 5. Locating Slack Loops and Butt Splices

- 5.1 To identify the presence of a slack loop or butt splice in a cable path, first locate and mark the cable path.
- 5.2 Find the strongest response over the marked cable path and reset the gain.
- 5.3 Retrace the cable path with the Receiver held so the handle is perpendicular to (across) the cable path, as shown. When the Receiver passes over a slack loop or butt splice, the signal increases and the bar graph closes. Mark each response. Whenever you encounter such a condition, check to see if an unknown lateral exists.

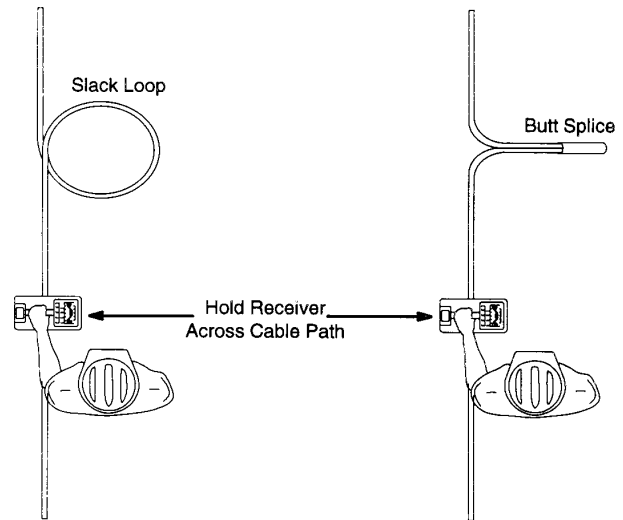

## 6. Locating Unknown Laterals

- 6.1 To check for unknown laterals which may radiate from a butt splice type or closure, first trace and mark the cable path. Retrace to locate any butt splices or slack loops. Mark the spot of any detected butt splices or slack loops.
- 6.2 If the Receiver gain has not been set while performing the normal trace, go to the marked trace path and pinpoint the path. Reset the gain.
- 6.3 Walk 10 to 25 feet off the trace path and away from the marked butt splice or slack loop. Hold the Receiver so that the display end of the handle points directly to the mark. Walk in a circle around the mark with the Receiver handle pointing to the mark.
- 6.4 The Receiver remains relatively quiet until it crosses a lateral or the actual cable path. Since there could be several laterals radiating from the closure, mark each occurrence of signal around the circle. After you locate each lateral, trace and mark its path.

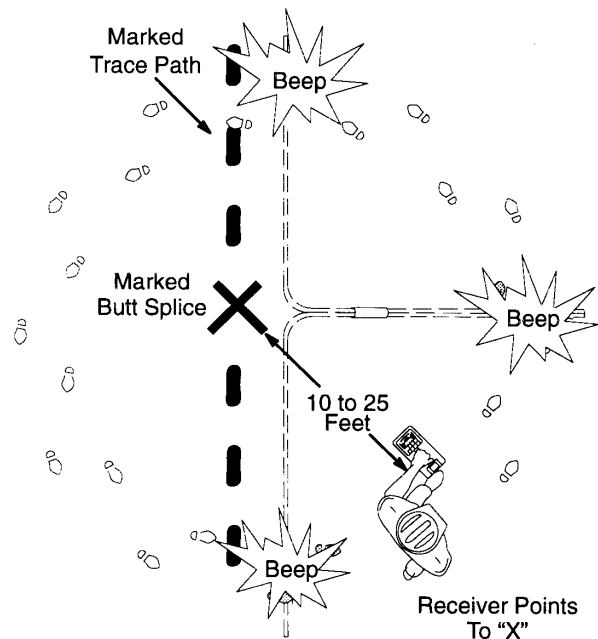



## 7. Locating Cables from Pedestals

- 7.1 To locate a single cable path from a pedestal, follow these steps:
- 7.2 At the pedestal, apply tracing signal on the target cable using the Dyna-Coupler method. If the header in the pedestal is not grounded, use the ground rod and ground extension cable to ground it.
- 7.3 Walk 10 to 25 feet away from the pedestal. Hold the Receiver so that the display end of the handle points directly to the pedestal. Start walking in a circle around the pedestal with the Receiver always pointing toward the pedestal.
- 7.4 The Receiver remains relatively quiet until it crosses a cable. Stop when there is a response. Find the point of strongest signal and press gain. Check the numeric display for relative signal strength. Remember the number and continue walking the circle. As you walk away from the cable, the signal drops. Press gain and continue. When you encounter another response, find the point of strongest signal. If the greatest signal strength is more than 25 points higher than the others (if any found), then that is the target cable. If the signal levels are closer, then measure the depth of each cable found and note the bar graph in the depth mode (this is a relative measurement of the current flowing in the cable). In the depth mode, the cable that shows at least two more segments on the bar graph than the other cables is the target cable.

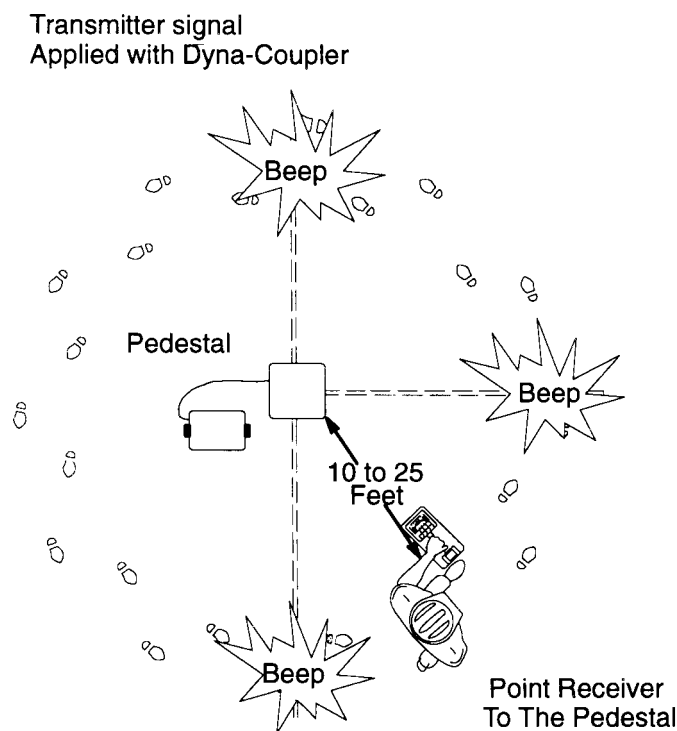

## **8. Locating Service Drops**

- 8.1 When locating the path of a service drop from a house or other building, it is more convenient to apply signal at the house or building. Connect the Transmitter using the direct-connect method. Use the standard tracing techniques described earlier.

## **9. Locating an Open End**

- 9.1 To locate an unterminated or open end of a cable or drop, follow these steps.
- 9.2 If the cable is bonded to ground at the access point, connect the Transmitter using the Dyna-Coupler method. Otherwise, if the cable is not bonded to ground at the access point, connect the Transmitter using the Direct-connect method. With either method, choose the highest frequency available, at high level.
- 9.3 Trace the cable path. The receiver's response decreases suddenly at the site of the clear or severed end.

## **10. Identifying Cables**

- 10.1 This procedure identifies a single cable in a group of similar cables. At an access where cable identity is known, use the Transmitter to put signal on the sought cable with the Dyna-Coupler. Select the highest frequency available. Output level should be set to high. It is not necessary to remove any bonds or ground. At an access at the far-end of the cable group, connect another Dyna-Coupler to the Receiver with the Extension Cable. On the Receiver, select the PEAK trace mode. Select the same frequency as the Transmitter. Check the first cable in the group by clamping the Dyna-Coupler around the cable. Press the GAIN ADJUST key and observe the numeric display, which is relative signal strength. Remember the number and continue by clamping the Dyna-Coupler around the next cable in the group. If the signal strength is greater than the previous observation, press the GAIN ADJUST key. If the signal strength is less than before, ignore it. After checking all the cables in the group, the cable with the highest reading is the one being sought.