



Chipsmall Limited consists of a professional team with an average of over 10 year of expertise in the distribution of electronic components. Based in Hongkong, we have already established firm and mutual-benefit business relationships with customers from,Europe,America and south Asia,supplying obsolete and hard-to-find components to meet their specific needs.

With the principle of “Quality Parts,Customers Priority,Honest Operation,and Considerate Service”,our business mainly focus on the distribution of electronic components. Line cards we deal with include Microchip,ALPS,ROHM,Xilinx,Pulse,ON,Everlight and Freescale. Main products comprise IC,Modules,Potentiometer,IC Socket,Relay,Connector.Our parts cover such applications as commercial,industrial, and automotives areas.

We are looking forward to setting up business relationship with you and hope to provide you with the best service and solution. Let us make a better world for our industry!



Contact us

Tel: +86-755-8981 8866 Fax: +86-755-8427 6832

Email & Skype: info@chipsmall.com Web: www.chipsmall.com

Address: A1208, Overseas Decoration Building, #122 Zhenhua RD., Futian, Shenzhen, China



- ◆ N-Channel Enhancement Mode
- ◆ Low Q_g and R_g
- ◆ High dv/dt
- ◆ Nanosecond Switching
- ◆ 30MHz Maximum Frequency

Symbol	Test Conditions	Maximum Ratings	
V_{DSS}	$T_J = 25^\circ\text{C to } 150^\circ\text{C}$	1000	V
V_{DGR}	$T_J = 25^\circ\text{C to } 150^\circ\text{C}; R_{GS} = 1\text{ M}\Omega$	1000	V
V_{GS}	Continuous	± 20	V
V_{GSM}	Transient	± 30	V
I_{D25}	$T_c = 25^\circ\text{C}$	24	A
I_{DM}	$T_c = 25^\circ\text{C}$, pulse width limited by T_{JM}	144	A
I_{AR}	$T_c = 25^\circ\text{C}$	21	A
E_{AR}	$T_c = 25^\circ\text{C}$	30	mJ
dv/dt	$I_S \leq I_{DM}$, $di/dt \leq 100\text{A}/\mu\text{s}$, $V_{DD} \leq V_{DSS}$, $T_J \leq 150^\circ\text{C}$, $R_G = 0.2\Omega$	5	V/ns
	$I_S = 0$	>200	V/ns
P_{DC}		1800	W
P_{DHS}	$T_c = 25^\circ\text{C}$ Derate 4.0W/ $^\circ\text{C}$ above 25°C	730	W
P_{DAMB}	$T_c = 25^\circ\text{C}$	4.5	W
R_{thJC}		0.08	C/W
R_{thJHS}		0.20	C/W

Symbol	Test Conditions	Characteristic Values		
		$T_J = 25^\circ\text{C}$ unless otherwise specified		
		min.	typ.	max.
V_{DSS}	$V_{GS} = 0\text{ V}$, $I_D = 3\text{ ma}$	1000		V
$V_{GS(th)}$	$V_{DS} = V_{GS}$, $I_D = 4\text{ ma}$	3.5	4.4	5.5 V
I_{GSS}	$V_{GS} = \pm 20\text{ V}_{DC}$, $V_{DS} = 0$			$\pm 100\text{ nA}$
I_{DSS}	$V_{DS} = 0.8\text{ V}_{DSS}$, $T_J = 25^\circ\text{C}$ $V_{GS} = 0$, $T_J = 125^\circ\text{C}$			50 μA
				1 mA
$R_{DS(on)}$	$V_{GS} = 15\text{ V}$, $I_D = 0.5I_{D25}$ Pulse test, $t \leq 300\mu\text{s}$, duty cycle $d \leq 2\%$			0.45 Ω
g_{fs}	$V_{DS} = 15\text{ V}$, $I_D = 0.5I_{D25}$, pulse test		12	S
T_J		-55		+175 $^\circ\text{C}$
T_{JM}			175	$^\circ\text{C}$
T_{stg}		-55		+175 $^\circ\text{C}$
T_L	1.6mm (0.063 in) from case for 10 s		300	$^\circ\text{C}$
Weight			3	g

$$V_{DSS} = 1000\text{ V}$$

$$I_{D25} = 24\text{ A}$$

$$R_{DS(on)} \leq 0.45\ \Omega$$

$$P_{DC} = 1800\text{ W}$$

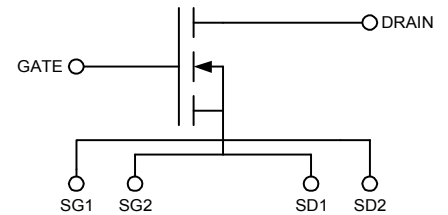
Features

- Isolated Substrate
 - high isolation voltage (>2500V)
 - excellent thermal transfer
 - Increased temperature and power cycling capability
- IXYS advanced low Q_g process
- Low gate charge and capacitances
 - easier to drive
 - faster switching
- Low $R_{DS(on)}$
- Very low insertion inductance (<2nH)
- No beryllium oxide (BeO) or other hazardous materials

Advantages

- Optimized for RF and high speed switching at frequencies to 30MHz
- Easy to mount—no insulators needed
- High power density



DE475-102N21A RF Power MOSFET

Symbol	Test Conditions	Characteristic Values		
		(T _J = 25°C unless otherwise specified)		
		min.	typ.	max.
R _G			0.3	Ω
C _{iss}			5500	pF
C _{oss}	V _{GS} = 0 V, V _{DS} = 0.8 V _{DSS(max)} , f = 1 MHz		190	pF
C _{rss}			52	pF
C _{stray}	Back Metal to any Pin		46	pF
T _{d(on)}			5	ns
T _{on}	V _{GS} = 15 V, V _{DS} = 0.8 V _{DSS} I _D = 0.5 I _{DM}		5	ns
T _{d(off)}	R _G = 0.2 Ω (External)		5	ns
T _{off}			8	ns
Q _{g(on)}			155	nC
Q _{gs}	V _{GS} = 10 V, V _{DS} = 0.5 V _{DSS} I _D = 0.5 I _{D25}		33	nC
Q _{gd}			84	nC

Source-Drain Diode		Characteristic Values		
		(T _J = 25°C unless otherwise specified)		
Symbol	Test Conditions	min.	typ.	max.
I _S	V _{GS} = 0 V			21 A
I _{SM}	Repetitive; pulse width limited by T _{JM}			144 A
V _{SD}	I _F = I _S , V _{GS} = 0 V, Pulse test, t ≤ 300 μs, duty cycle ≤ 2%			1.5 V
T _{rr}			200	ns
Q _{RM}	I _F = I _S , -di/dt = 100A/μs, V _R = 100V		0.6	μC
I _{RM}			8	A

CAUTION: Operation at or above the Maximum Ratings values may impact device reliability or cause permanent damage to the device.

Information in this document is believed to be accurate and reliable. IXYSRF reserves the right to make changes to information published in this document at any time and without notice.

For detailed device mounting and installation instructions, see the “*Device Installation & Mounting Instructions*” technical note on the IXYSRF web site at;

http://www.ixysrf.com/pdf/switch_mode/appnotes/7de_series_mosfet_installation_instructions.pdf

IXYS RF reserves the right to change limits, test conditions and dimensions.

IXYS RF MOSFETS are covered by one or more of the following U.S. patents:

4,835,592	4,860,072	4,881,106	4,891,686	4,931,844	5,017,508
5,034,796	5,049,961	5,063,307	5,187,117	5,237,481	5,486,715
5,381,025	5,640,045				

Fig. 1 **Typical Transfer Characteristics**
 $V_{DS} = 50V, I_D = 12A$

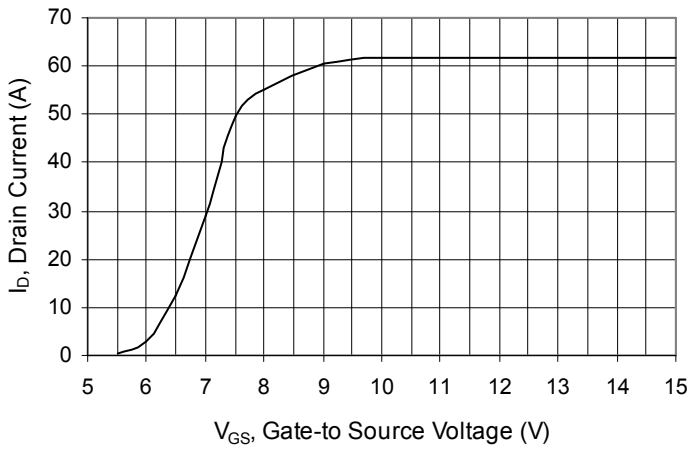

Fig. 2 **Typical Output Characteristics**
 $PW = 15 \mu S$

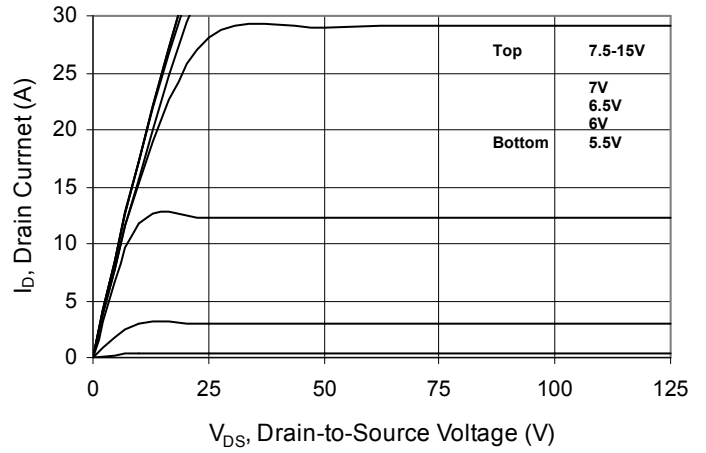

Fig. 3 **Gate Charge vs. Gate-to-Source Voltage**
 $V_{DS} = 500V, I_D = 12A$

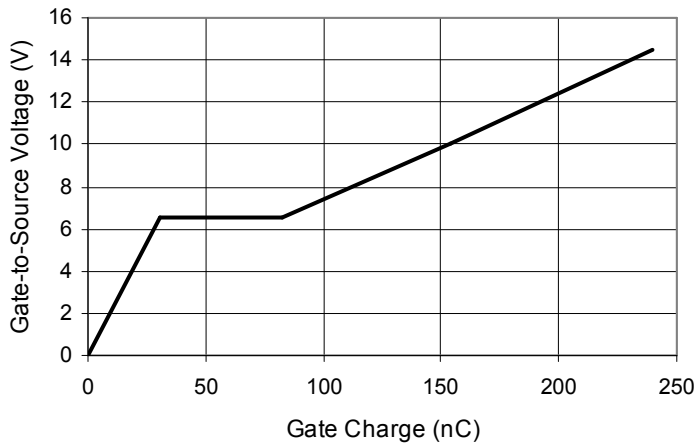

Fig. 4 **Extended Typical Output Characteristics**
 $PW = 15 \mu S$

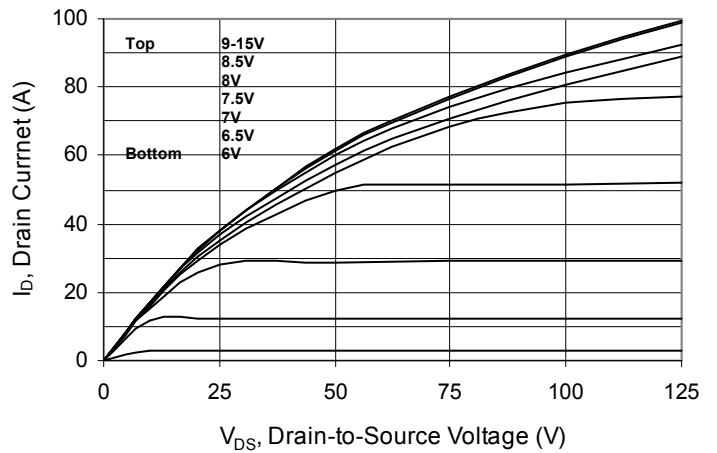

Fig. 5 **V_{DS} vs. Capacitance**

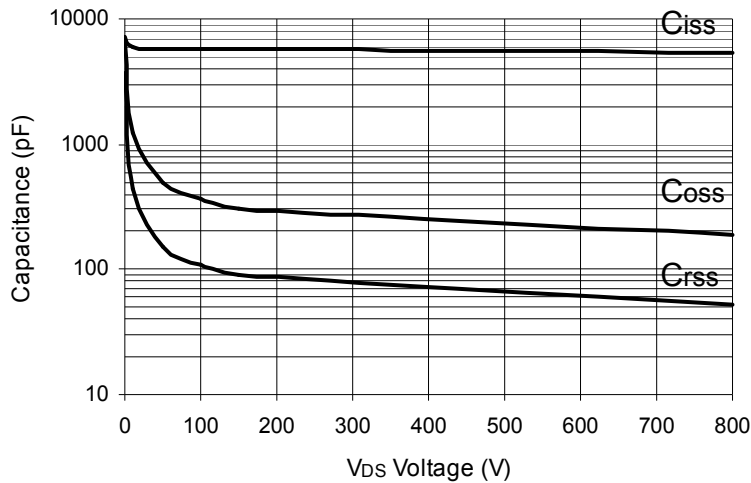
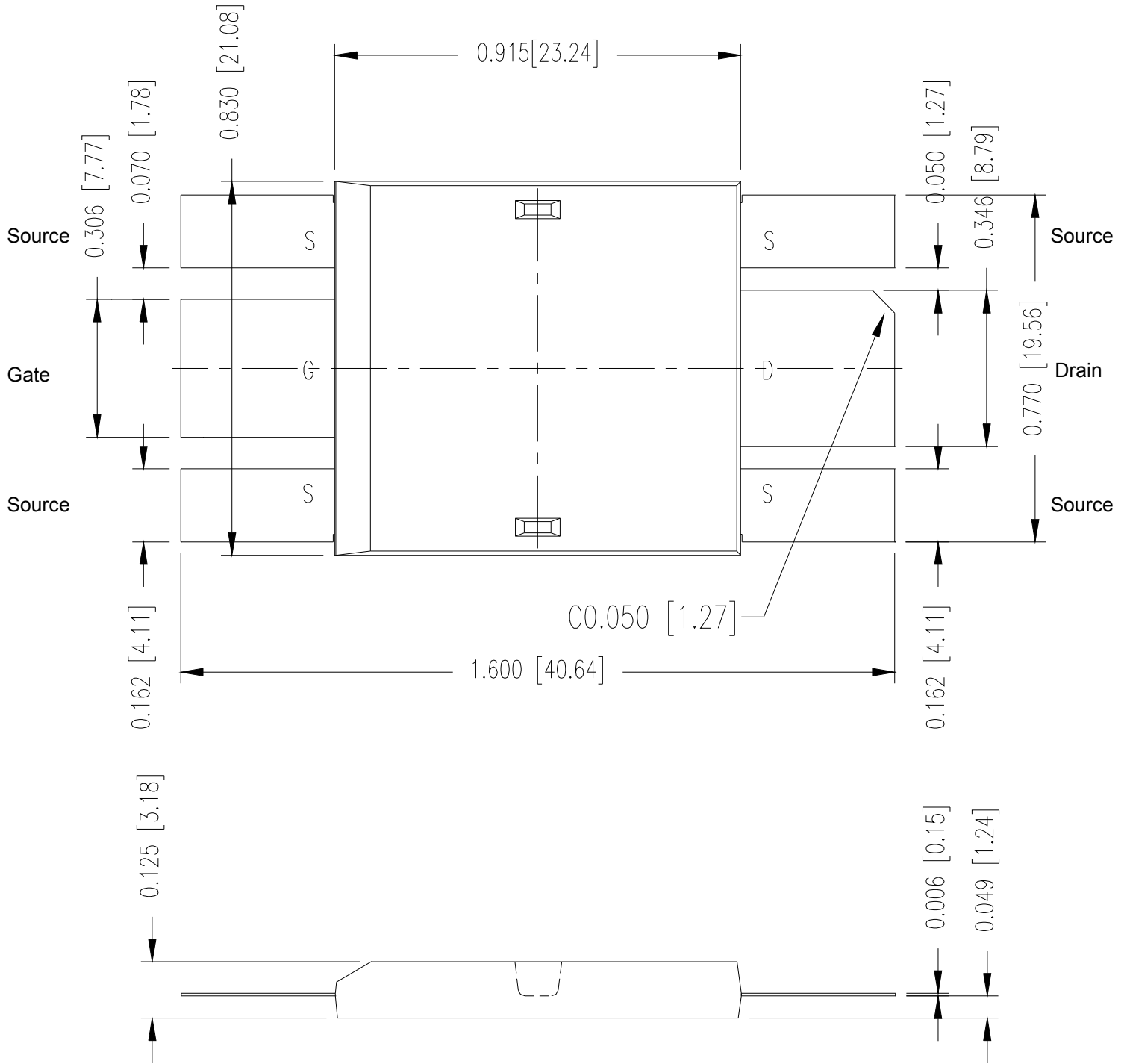

Fig. 6 Package Drawing



102N21A DE-SERIES SPICE Model (Preliminary)

The DE-SERIES SPICE Model is illustrated in Figure 7. The model is an expansion of the SPICE level 3 MOSFET model. It includes the stray inductive terms L_G , L_S and L_D . R_d is the $R_{DS(ON)}$ of the device, R_{ds} is the resistive leakage term. The output capacitance, C_{OSS} , and reverse transfer capacitance, C_{RSS} are modeled with reversed biased diodes. This provides a varactor type response necessary for a high power device model. The turn on delay and the turn off delay are adjusted via R_{on} and R_{off} .

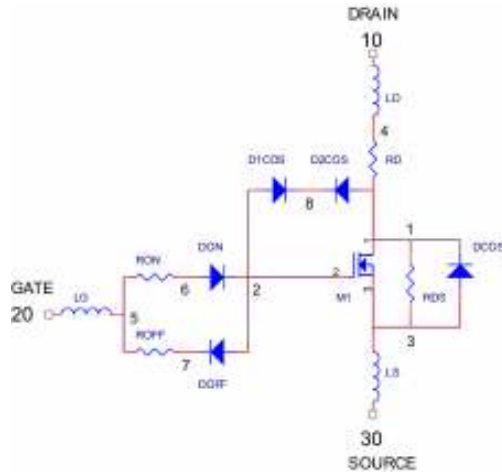

Figure 7 DE-SERIES SPICE Model

This SPICE model may be downloaded as a text file from the IXYSRF web site at

http://www.ixysrf.com/products/switch_mode.html

<http://www.ixysrf.com/spice/de475-102n21a.html>

Net List:

```
.SUBCKT 102N21A 10 20 30
* TERMINALS: D G S
* 1000 Volt 21 Amp 0.45 ohm N-Channel Power MOSFET
* REV.A 01-09-02
M1 1 2 3 3 DMOS L=1U W=1U
RON 5 6 0.3
DON 6 2 D1
ROF 5 7 .1
DOF 2 7 D1
D1CRS 2 8 D2
D2CRS 1 8 D2
CGS 2 3 5.5N
RD 4 1 0.45
DCOS 3 1 D3
RDS 1 3 5.0MEG
LS 3 30 .5N
LD 10 4 1N
LG 20 5 1N
.MODEL DMOS NMOS (LEVEL=3 VTO=3.0 KP=3.8)
.MODEL D1 D (IS=.5F CJO=1P BV=100 M=.5 VJ=.6 TT=1N)
.MODEL D2 D (IS=.5F CJO=400P BV=1000 M=.4 VJ=.6 TT=400N RS=10M)
.MODEL D3 D (IS=.5F CJO=900P BV=1000 M=.3 VJ=.4 TT=400N RS=10M)
.ENDS
```

Doc #9200-0247 Rev 6
© 2009 IXYS RF



An IXYS Company
2401 Research Blvd., Suite 108
Fort Collins, CO USA 80526
970-493-1901 Fax: 970-493-1903
Email: sales@ixyscolorado.com
Web: <http://www.ixyscolorado.com>