



Chipsmall Limited consists of a professional team with an average of over 10 year of expertise in the distribution of electronic components. Based in Hongkong, we have already established firm and mutual-benefit business relationships with customers from,Europe,America and south Asia,supplying obsolete and hard-to-find components to meet their specific needs.

With the principle of “Quality Parts,Customers Priority,Honest Operation,and Considerate Service”,our business mainly focus on the distribution of electronic components. Line cards we deal with include Microchip,ALPS,ROHM,Xilinx,Pulse,ON,Everlight and Freescale. Main products comprise IC,Modules,Potentiometer,IC Socket,Relay,Connector.Our parts cover such applications as commercial,industrial, and automotives areas.

We are looking forward to setting up business relationship with you and hope to provide you with the best service and solution. Let us make a better world for our industry!



Contact us

Tel: +86-755-8981 8866 Fax: +86-755-8427 6832

Email & Skype: info@chipsmall.com Web: www.chipsmall.com

Address: A1208, Overseas Decoration Building, #122 Zhenhua RD., Futian, Shenzhen, China



A B C D E F G H

ALL DRAWINGS AND SPECIFICATIONS ARE THE SOLE PROPERTY OF I/O INTERCONNECT INC. NO PART OF THIS DOCUMENT, EITHER WHOLE OR IN PART, MAY BE REPRODUCED, COPIED, OR USED IN ANY MANNER WITHOUT THE PRIOR WRITTEN CONSENT OF I/O INTERCONNECT INC. OR ITS AFFILIATED SUBSIDIARIES.

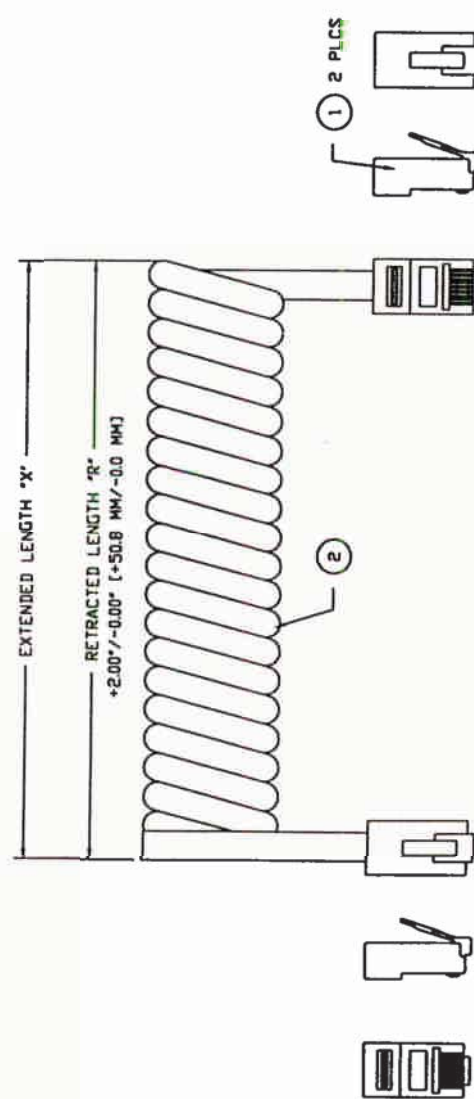

WIRE DIAGRAM

P1	P2
1	GRAY
2	ORANGE
3	BLACK
4	RED
5	GREEN
6	YELLOW
7	BLUE
8	BROWN

CUSTOMER APPROVAL
 ENGR. SIGN *Matt Lerner*
 DATE: 4-13-99

- NOTES: UNLESS OTHERWISE SPECIFIED.
1. TEST CABLE FOR ALL OPENS & SHORTS.
 2. PACKAGE CABLE ASSEMBLY INDIVIDUALLY IN PLASTIC BAG. PACKAGE INDIVIDUAL BAG PER LOT NUMBER QUANTITIES.

488-148-505-D	121-810-022	14.0 FT (4.3 M)	50.0 IN (1270.0 MM)	WHITE
488-148-504-D	121-810-012	14.0 FT (4.3 M)	50.0 IN (1270.0 MM)	BLACK
488-148-503-D	121-810-002	14.0 FT (4.3 M)	50.0 IN (1270.0 MM)	SILVER SATIN
488-108-502-D	121-810-021	10.0 FT (3.0 M)	42.0 IN (1066.8 MM)	WHITE
488-108-501-D	121-810-011	10.0 FT (3.0 M)	42.0 IN (1066.8 MM)	BLACK
488-108-500-D	121-810-001	10.0 FT (3.0 M)	42.0 IN (1066.8 MM)	SILVER SATIN
488-078-505-D	121-810-020	7.0 FT (2.1 M)	28.0 IN (711.2 MM)	WHITE
488-078-504-D	121-810-010	7.0 FT (2.1 M)	28.0 IN (711.2 MM)	BLACK
488-078-503-D	121-810-000	7.0 FT (2.1 M)	28.0 IN (711.2 MM)	SILVER SATIN
488-058-502-D	121-810-023	5.0 FT (1.5 M)	22.0 IN (558.8 MM)	WHITE
488-058-501-D	121-810-013	5.0 FT (1.5 M)	22.0 IN (558.8 MM)	BLACK
488-058-500-D	121-810-003	5.0 FT (1.5 M)	22.0 IN (558.8 MM)	SILVER SATIN
IOI PART NUMBER	IOI CABLE PART NUMBER	EXTENDED LENGTH "X"	RETRACTED LENGTH "R"	

TABULATION BLOCK

THIRD ANGLE PROJECTION

UNLESS OTHERWISE NOTED, DIMENSIONS ARE IN INCHES (MILLIMETERS)
 TOLERANCES:
 X.XX ± 0.25 (6.35)

I/O INTERCONNECT
 SANTA ANA, CALIFORNIA

REV. X2
 SHEET 1 OF 1

ITEM	QTY	MFG.	IOI PART NO.	DESCRIPTION
2	2 PCS			MODULAR COIL CABLE, 26 AVG (7/34) BARE COPPER, 8 CONDUCTOR, UNSHIELDED, PVC JACKET, (SEE TABULATION BLOCK FOR COLOR).
1	2 PCS			CONNECTOR, MODULAR PLUG, 8 POSITION, 8 CONDUCTOR, 50U" AU, FLAT TYPE EXIT.

CABLE ASSEMBLY PARTS LIST

A	B	C	D	E	F	G	H
DWG. NO. XXB-502-D		REV. X1	ZONE	DESCRIPTION CUSTOMER APPROVAL	DATE 03/24/99	APPROVED E.V.	

THESE DRAWINGS AND SPECIFICATIONS ARE THE SOLE PROPERTY OF I/O INTERCONNECT INC., U.S.A. AND SHALL NOT BE REPRODUCED, COPIED, OR USED IN ANY MANNER WITHOUT THE WRITTEN CONSENT OF I/O INTERCONNECT INC. OR ITS AFFILIATED SUBSIDIARIES.

WIRE DIAGRAM

P1	P2
1	GRAY
2	ORANGE
3	BLACK
4	RED
5	GREEN
6	YELLOW
7	BLUE
8	BROWN

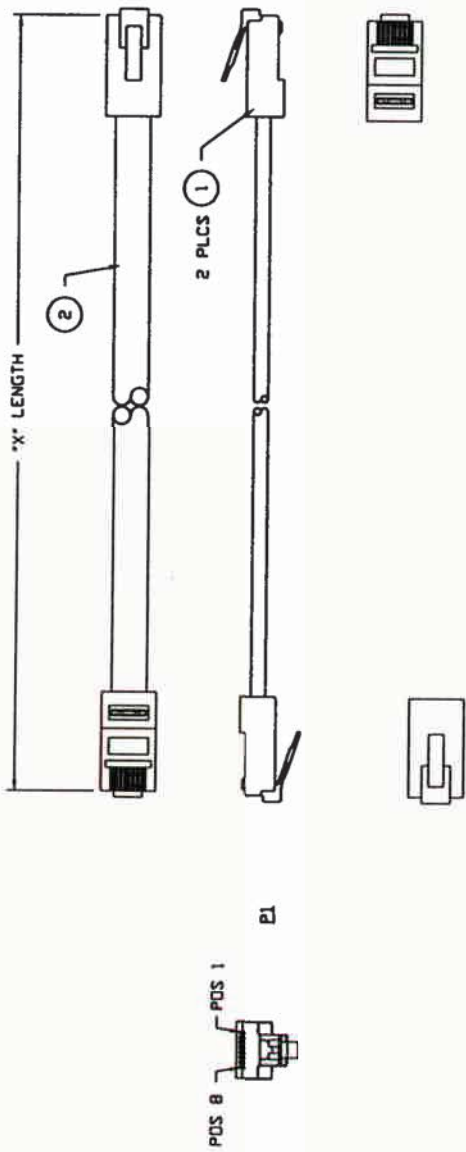

CUSTOMER APPROVAL
ENGR. SIGN Math. Demme
DATE: 4-17-99

H2881-25-ND
H2881-14-ND
H2881-07-ND

- NOTES: UNLESS OTHERWISE SPECIFIED.
- CABLE TO BE BUNDLED AND TWIST TIED.
 - TEST CABLE FOR ALL OPENS & SHORTS.
 - PACKAGE CABLE ASSEMBLY INDIVIDUALLY IN PLASTIC BAG. PACKAGE INDIVIDUAL BAG PER LOT NUMBER QUANTITIES.

488-258-502-D	25.0 FT ± 4.0 IN 7.62 M ± 101.6 MM
488-148-502-D	14.0 FT ± 3.0 IN 4.27 M ± 76.2 MM
488-078-502-D	7.0 FT ± 2.0 IN 2.13 M ± 50.8 MM

PART NUMBER
I/O INTERCONNECT

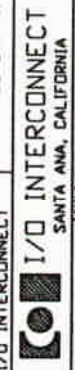

TITLE I/O INTERCONNECT SANTA ANA, CALIFORNIA	REV. NO. 001	REV. DATE 03/24/99
DESCRIPTION BPBP MODULAR, REVERT STYLE, WHITE, CABLE ASSEMBLY	PART NO. 488-XXB-502-D	REV. NO. 001
QUANTITY 1	REV. NO. 001	REV. DATE 03/24/99
DATE/PLACED 03/24/99	DATE/REV. 03/24/99	DATE/REV. 03/24/99
SCALE NONE	SHEET 1	OF 1

ITEM	QTY	MFG.	IDI PART NO.	DESCRIPTION
2	*X*	IDI	120-810-020	MODULAR CABLE, 26 AVG (7/34) BARE COPPER, 8 CONDUCTOR, UNSHIELDED, WHITE PVC.
1	2 PCS	IDI	325-881-50X	CONNECTOR, MODULAR PLUG, 8 POSITION, 8 CONDUCTOR, 50u" AU, FLAT TYPE EXIT.

CABLE ASSEMBLY PARTS LIST

A B C D E F G H

THESE DIMENSIONS AND SPECIFICATIONS ARE THE SOLE PROPERTY OF I/O INTERCONNECT INC., U.S.A. AND SHALL NOT BE REPRODUCED, COPIED, OR USED IN ANY MANNER WITHOUT THE PRIOR WRITTEN CONSENT OF I/O INTERCONNECT INC. OR ITS AFFILIATED SUBSIDIARIES.

DWG. NO.	ZONE	REV.	DESCRIPTION	DATE	APPROVED
XXB-310-D	XI	XI	CUSTOMER APPROVAL	03/24/99	E.V.

WIRE DIAGRAM

P1	1	GRAY	P2	8
	2	ORANGE		7
	3	BLACK		6
	4	RED		5
	5	GREEN		4
	6	YELLOW		3
	7	BLUE		2
	8	BROWN		1

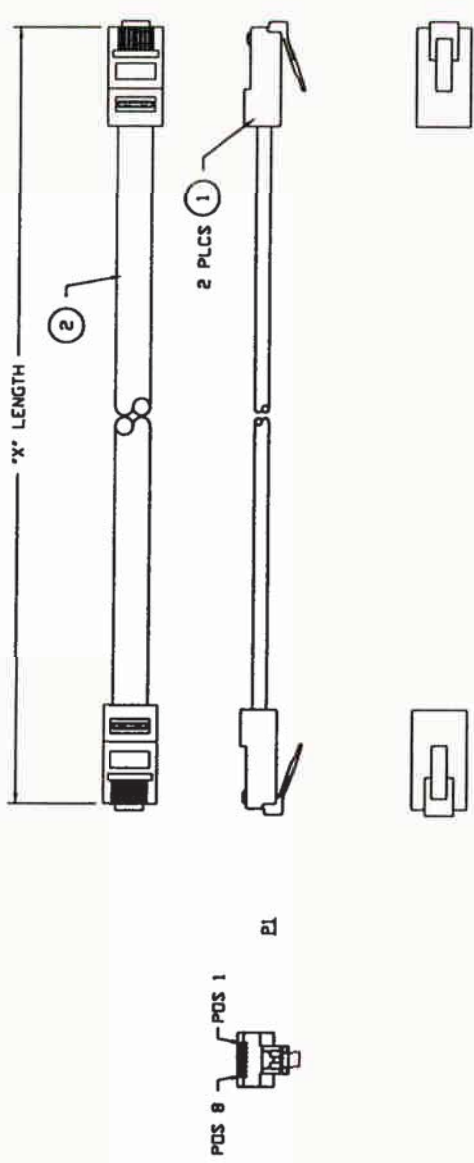

CUSTOMER APPROVAL
ENGR. SIGN *Matt Lopez*
DATE: 4-12-99

H1883-25-ND
H1883-14-ND
H1883-07-ND

- NOTES: UNLESS OTHERWISE SPECIFIED.
- CABLE TO BE BUNDLED AND TWIST TIED.
 - TEST CABLE FOR ALL OPENS & SHORTS.
 - PACKAGE CABLE ASSEMBLY INDIVIDUALLY IN PLASTIC BAG. PACKAGE INDIVIDUAL BAG PER LOT NUMBER QUANTITIES.

488-258-510-D	25.0 FT ± 4.0 IN 7.62 M ± 101.6 MM
488-148-510-D	14.0 FT ± 3.0 IN 4.27 M ± 76.2 MM
488-078-510-D	7.0 FT ± 2.0 IN 2.13 M ± 50.8 MM
PART NUMBER	LENGTH 'X'

I/O INTERCONNECT
SANTA ANA, CALIFORNIA

THIRD ANGLE PROJECTION

UNLESS OTHERWISE NOTED:
1) DIMENSIONS ARE IN INCHES (MILLIMETER)
2) TOLERANCES:
X.XX ± 0.25 (6.35)

REV.	REV.
XI	XI

ITEM	QTY	MFG.	DOI PART NO.	DESCRIPTION
2	"X"	IOI	120-810-000	MODULAR CABLE, 26 AWG (7/34) BARE COPPER, 8 CONDUCTOR, UNSHIELDED, SILVER SATIN PVC.
1	2 PCS	IOI	325-881-50X	CONNECTOR, MODULAR PLUG, 8 POSITION, 8 CONDUCTOR, 50.0" AW, FLAT TYPE EXIT.

CABLE ASSEMBLY PARTS LIST

SCALE	NONE	SHEET	1	OF	1
-------	------	-------	---	----	---

THESE DRAWINGS AND SPECIFICATIONS ARE THE SOLE PROPERTY OF I/O INTERCONNECT INC., U.S.A. AND SHALL NOT BE REPRODUCED, COPIED, OR USED IN ANY MANNER WITHOUT THE WRITTEN CONSENT OF I/O INTERCONNECT INC. OR ITS AFFILIATED SUBSIDIARIES.

DWG. NO.	ZONE	REV.	DESCRIPTION	DATE	APPROVED
XXB-511-D	XI	XI	CUSTOMER APPROVAL	03/24/99	E.V.

WIRE DIAGRAM

P1	1	GRAY	P2
	2	ORANGE	8
	3	BLACK	7
	4	RED	6
	5	GREEN	5
	6	YELLOW	4
	7	BLUE	3
	8	BROWN	2
			1

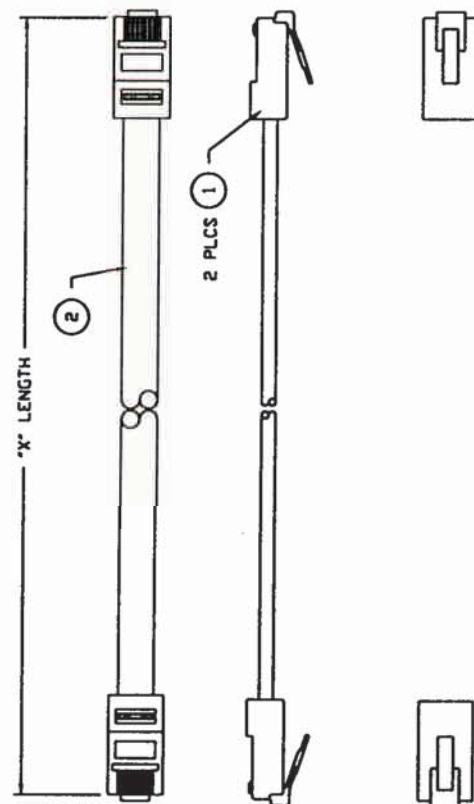

CUSTOMER APPROVAL
 ENGR. SIGN YMaH Neme
 DATE: 4-12-99

H1882-25-ND
 H1882-14-ND
 H1882-07-ND

- NOTES: UNLESS OTHERWISE SPECIFIED.
1. CABLE TO BE BUNDLED AND TWIST TIED.
 2. TEST CABLE FOR ALL OPENS & SHORTS.
 3. PACKAGE CABLE ASSEMBLY INDIVIDUALLY IN PLASTIC BAG. PACKAGE INDIVIDUAL BAG PER LOT NUMBER QUANTITIES.

488-259-511-D	25.0 FT ± 4.0 IN 7.62 M ± 101.6 MM
488-148-511-D	14.0 FT ± 3.0 IN 4.27 M ± 76.2 MM
488-078-511-D	7.0 FT ± 2.0 IN 2.13 M ± 50.8 MM

PART NUMBER I/O INTERCONNECT LENGTH "X"

I/O INTERCONNECT
 SANTA ANA, CALIFORNIA

TITLE: 8P8P MODULAR, STANDARD STYLE, BLACK, CABLE ASSEMBLY
 PART NO.: 488-XXB-511-D
 DWG NO.: 488-XXB-511-D
 CUSTOMER: DIGI KEY
 SCALE: NONE SHEET 1 OF 1

THIRD ANGLE PROJECTION

UNLESS OTHERWISE NOTED:
 1) DIMENSIONS ARE IN INCHES (MILLIMETER)
 2) TOLERANCES:
 X.XX ± 0.25 (6.35)

ITEM	QTY	MFG.	IDT PART NO.	DESCRIPTION
2	"X"	IOI	120-810-010	MODULAR CABLE, 26 AWG (7/34) BARE COPPER, 8 CONDUCTOR, UNSHIELDED, BLACK PVC.
1	2 PCS	IOI	325-881-50X	CONNECTOR, MODULAR PLUG, 8 POSITION, 8 CONDUCTOR, 50u" Au, FLAT TYPE EXIT.

CABLE ASSEMBLY PARTS LIST

A B C D E F G H

THESE DRAWINGS AND SPECIFICATIONS ARE THE SOLE PROPERTY OF I/O INTERCONNECT INC., U.S.A. AND SHALL NOT BE REPRODUCED, COPIED, OR USED IN ANY MANNER WITHOUT THE PRIOR WRITTEN CONSENT OF I/O INTERCONNECT INC. OR ITS AFFILIATED SUBSIDIARIES.

DWG. NO. XXB-501-D	ZONE X1	REV. X1	DESCRIPTION CUSTOMER APPROVAL	DATE 03/24/99	APPROVED E.W.
-----------------------	------------	------------	----------------------------------	------------------	------------------

WIRE DIAGRAM

P1	P2
1	GRAY
2	ORANGE
3	BLACK
4	RED
5	GREEN
6	YELLOW
7	BLUE
8	BROWN

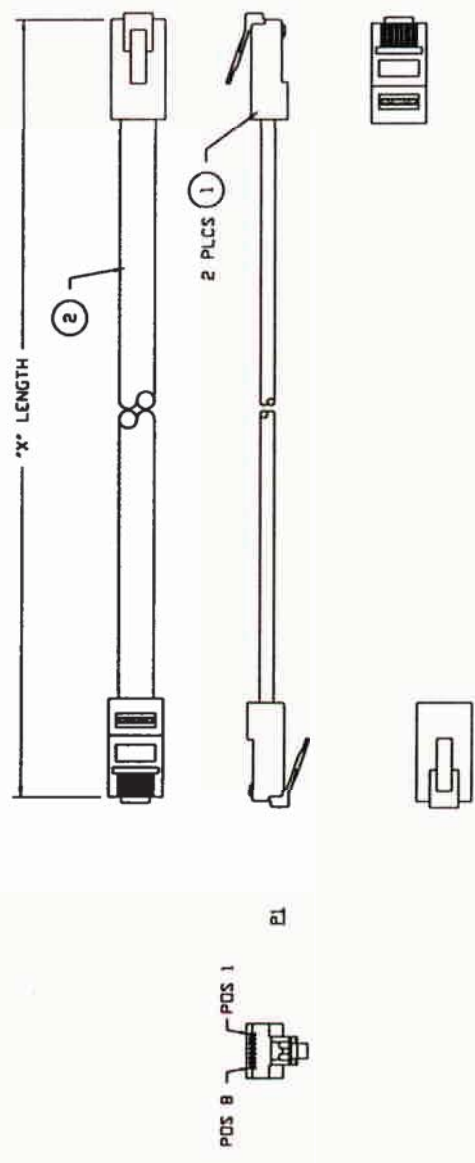

CUSTOMER APPROVAL
 ENGR. SIGN Math Amel
 DATE: 4-12-99

H2882-25-ND
 H2882-14-ND
 H2882-07-ND

- NOTES: UNLESS OTHERWISE SPECIFIED.
- CABLE TO BE BUNDLED AND TWIST TIED.
 - TEST CABLE FOR ALL OPENS & SHORTS.
 - PACKAGE CABLE ASSEMBLY INDIVIDUALLY IN PLASTIC BAG. PACKAGE INDIVIDUAL BAG PER LOT NUMBER QUANTITIES.

2	*X	IOI	120-810-010	MODULAR CABLE, 26 AWG (7/34) BARE COPPER, 8 CONDUCTOR, UNSHIELDED, BLACK PVC.
1	2 PCS	IOI	325-881-50X	CONNECTOR, MODULAR PLUG, 8 POSITION, 8 CONDUCTOR, 50u" AW, FLAT TYPE EXIT.
ITEM	QTY	MFG.	IOI PART NO.	DESCRIPTION

CABLE ASSEMBLY PARTS LIST

488-258-501-D	25.0 FT ± 4.0 IN 7.62 M ± 101.6 MM
488-148-501-D	14.0 FT ± 3.0 IN 4.27 M ± 76.2 MM
488-078-501-D	7.0 FT ± 2.0 IN 2.13 M ± 50.8 MM
PART NUMBER I/O INTERCONNECT	LENGTH *X*

I/O INTERCONNECT
 SANTA ANA, CALIFORNIA

TITLE: BP8P MODULAR, REVERT STYLE, BLACK, CABLE ASSEMBLY

PART NO.: 488-XXB-501-D

DWG. NO.: 488-XXB-501-D

CUSTOMER: DIGI KEY

SCALE: NONE

SHEET 1 OF 1

THIRD ANGLE PROJECTION

UNLESS OTHERWISE NOTED:
 1) DIMENSIONS ARE IN INCHES (MILLIMETER)
 2) TOLERANCES:
 XXX ± 0.25 (6-35)

A B C D E F G H

THESE DRAWINGS AND SPECIFICATIONS ARE THE SOLE PROPERTY OF I/O INTERCONNECT INC. NO REPRODUCTION, COPIES, OR USE IN ANY MANNER WITHOUT THE WRITTEN CONSENT OF I/O INTERCONNECT INC. OR ITS AFFILIATED SUBSIDIARIES.

DWG. NO. XXB-500-D	ZONE	REV. X1	DESCRIPTION CUSTOMER APPROVAL	DATE 03/24/99	APPROVED E.V.
-----------------------	------	------------	----------------------------------	------------------	------------------

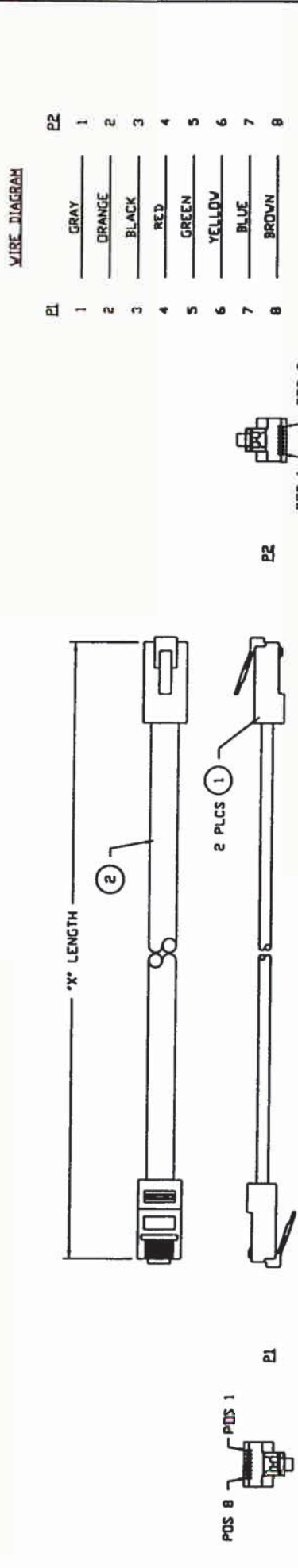

250 FT ± 4.0 IN
7.62 M ± 101.6 MM

14.0 FT ± 3.0 IN
4.27 M ± 76.2 MM

7.0 FT ± 2.0 IN
2.13 M ± 50.8 MM

PART NUMBER
I/O INTERCONNECT

LENGTH 'X'

H2883-25-ND
H2883-14-ND
H2883-07-ND

CUSTOMER APPROVAL
ENGR. SIGN Y. Matt Jensen
DATE: 4-17-99

NOTES: UNLESS OTHERWISE SPECIFIED.
1. CABLE TO BE BUNDLED AND TWIST TIED.
2. TEST CABLE FOR ALL OPENS & SHORTS.
3. PACKAGE CABLE ASSEMBLY INDIVIDUALLY IN PLASTIC BAG.
PACKAGE INDIVIDUAL BAG PER LOT NUMBER QUANTITIES.

2	"X"	IOI	120-810-000	MODULAR CABLE, 26 AVG (7/34) BARE COPPER, 8 CONDUCTOR, UNSHIELDED, SILVER SATIN PVC.
1	2 PCS	IOI	325-881-50X	CONNECTOR, MODULAR PLUG, 8 POSITION, 8 CONDUCTOR, 50µ" Au, FLAT TYPE EXIT.
ITEM	QTY	MFG.	IOI PART NO.	DESCRIPTION

CABLE ASSEMBLY PARTS LIST

THIRD ANGLE PROJECTION

UNLESS OTHERWISE NOTED:
1) DIMENSIONS ARE IN INCHES (MILLIMETER)
2) TOLERANCES:
XXX ± 0.25 (6.35)

I/O INTERCONNECT
SANTA ANA, CALIFORNIA

BPBP MODULAR, REVERT STYLE, SILVER SATIN, CABLE ASSEMBLY

PART NO. 488-XXB-500-D
REV. XI
CUSTOMER 488-XXB-500-D
DIGI KEY
SCALE: NONE SHEET 1 OF 1

A	B	C	D	E	F	G	H	
THESE DRAWINGS AND SPECIFICATIONS ARE THE SOLE PROPERTY OF I/O INTERCONNECT INC. - U.S.A. NO PARTS TO BE COPIED OR USED IN ANY MANNER WITHOUT THE WRITTEN CONSENT OF I/O INTERCONNECT INC. OR ITS AFFILIATED SUBSIDIARIES.		DWG. NO. XXB-521-D		ZONE	REV. X1	DESCRIPTION CUSTOMER APPROVAL	DATE 03/24/99	APPROVED E.V.

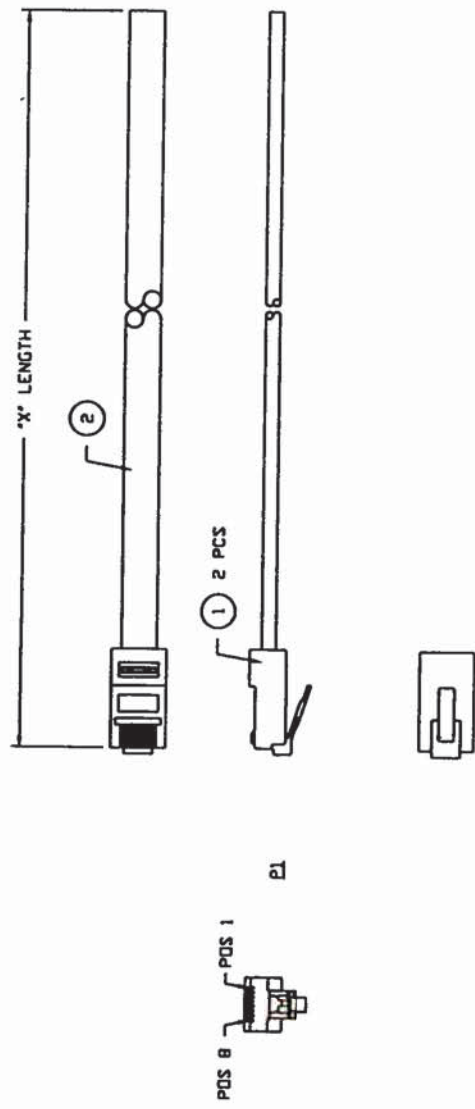

WIRE DIAGRAM

PI	OPEN END
1	GRAY
2	ORANGE
3	BLACK
4	RED
5	GREEN
6	YELLOW
7	BLUE
8	BROWN

CUSTOMER APPROVAL
 ENGR. SIGN Math Demas
 DATE: 4-17-99

488-258-521-D	25.0 FT ± 4.0 IN 7.62 M ± 101.6 MM
488-148-521-D	14.0 FT ± 3.0 IN 4.27 M ± 76.2 MM
488-078-521-D	7.0 FT ± 2.0 IN 2.13 M ± 50.8 MM

PART NUMBER		LENGTH 'X'
I/O INTERCONNECT		
I/O INTERCONNECT SANTA ANA, CALIFORNIA		
TITLE 8P8P MODULAR TO OPEN END BLACK, CABLE ASSEMBLY	PART NO. 488-XXB-521-D	REV. XI
DWG. NO. 488-XXB-521-D	CUSTOMER	DIGI KEY
SCALE	NONE	SHEET 1 OF 1

H3882-25-ND
 H3882-14-ND
 H3882-07-ND

THIRD ANGLE PROJECTION 	UNLESS OTHERWISE NOTED: 1) DIMENSIONS ARE IN INCHES (MILLIMETER) 2) TOLERANCES: XXX ± 0.25 (6.35)
----------------------------	--

- NOTES: UNLESS OTHERWISE SPECIFIED.
- CABLE TO BE BUNDLED AND TWIST TIED.
 - TEST CABLE FOR ALL OPENS & SHORTS.
 - PACKAGE CABLE ASSEMBLY INDIVIDUALLY IN PLASTIC BAG. PACKAGE INDIVIDUAL BAG PER LOT NUMBER QUANTITIES.

2	*X'	IDI	120-810-010	MODULAR CABLE, 26 AVG (7/34) BARE COPPER, 8 CONDUCTOR, UNSHIELDED, BLACK PVC.
1	1 PC	IDI	325-881-50X	CONNECTOR, MODULAR PLUG, 8 POSITION, 8 CONDUCTOR, 50U' AU, FLAT TYPE EXIT.
ITEM	QTY	MFG.	IDI PART NO.	DESCRIPTION
CABLE ASSEMBLY PARTS LIST				

A B C D E F G H

THESE DRAWINGS AND SPECIFICATIONS ARE THE SOLE PROPERTY OF I/O INTERCONNECT INC. NO PART OF THIS DOCUMENT IS TO BE REPRODUCED OR TRANSMITTED IN ANY FORM OR BY ANY MEANS WITHOUT THE WRITTEN CONSENT OF I/O INTERCONNECT INC. OR ITS AFFILIATED SUBSIDIARIES.

DWG. NO.	ZONE	REV.	DESCRIPTION	DATE	APPROVED
XXB-520-D		X1	CUSTOMER APPROVAL	03/24/99	E.V.

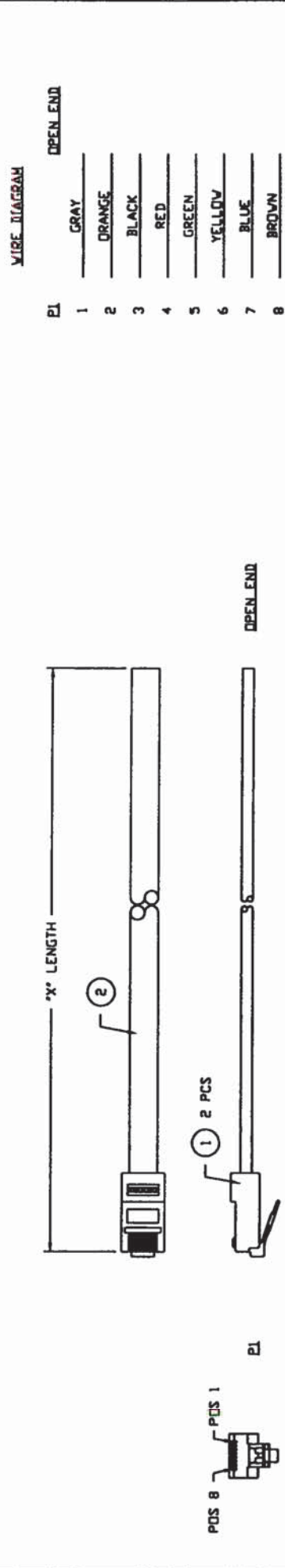

CUSTOMER APPROVAL
 ENGR. SIGN Math. Armer
 DATE: 4-12-99

H3883-25-ND
 H3883-14-ND
 H3883-67-ND

- NOTES: UNLESS OTHERWISE SPECIFIED.
- CABLE TO BE BUNDLED AND TWIST TIED.
 - TEST CABLE FOR ALL DPENS & SHORTS.
 - PACKAGE CABLE ASSEMBLY INDIVIDUALLY IN PLASTIC BAG. PACKAGE INDIVIDUAL BAG PER LOT NUMBER QUANTITIES.

488-258-920-D	25.0 FT ± 4.0 IN 7.62 M ± 101.6 MM
488-148-920-D	14.0 FT ± 3.0 IN 4.27 M ± 76.2 MM
488-078-920-D	7.0 FT ± 2.0 IN 2.13 M ± 50.8 MM
PART NUMBER	LENGTH "X"
I/O INTERCONNECT	

I/O INTERCONNECT
 SANTA ANA, CALIFORNIA

THIRD ANGLE PROJECTION

UNLESS OTHERWISE NOTED:
 1) DIMENSIONS ARE IN INCHES (MILLIMETER)
 2) TOLERANCES:
 X.XX ± 0.25 (6.35)

REV. X1

ITEM	QTY	MFG.	IOI PART NO.	DESCRIPTION
2	1	IOI	120-810-000	MODULAR CABLE, 26 AVG (7/34) BARE COPPER, 8 CONDUCTOR, UNSHIELDED, SILVER SATIN PVC.
1	1	IOI	325-881-50X	CONNECTOR, MODULAR PLUG, 8 POSITION, 8 CONDUCTOR, 50U" AU, FLAT TYPE EXIT.

CABLE ASSEMBLY PARTS LIST

REV.	REV. X1
DRAWN	DIGI KEY
CHECKED	NONE
SCALE	PAGE 1 OF 1

A	B	C	D	E	F	G	H	
THESE DRAWINGS AND SPECIFICATIONS ARE THE SOLE PROPERTY OF I/O INTERCONNECT INC., U.S.A. AND SHALL NOT BE REPRODUCED, COPIED OR USED IN ANY MANNER WITHOUT THE PRIOR WRITTEN CONSENT OF I/O INTERCONNECT INC. OR ITS AFFILIATED SUBSIDIARIES.		DIVG. NO. XXB-522-D		ZONE XI	REV. XI	DESCRIPTION CUSTOMER APPROVAL	DATE 03/24/99	APPROVED E.V.

WIRE DIAGRAM

PL	WIRE COLOR	OPEN END
1	GRAY	
2	ORANGE	
3	BLACK	
4	RED	
5	GREEN	
6	YELLOW	
7	BLUE	
8	BROWN	

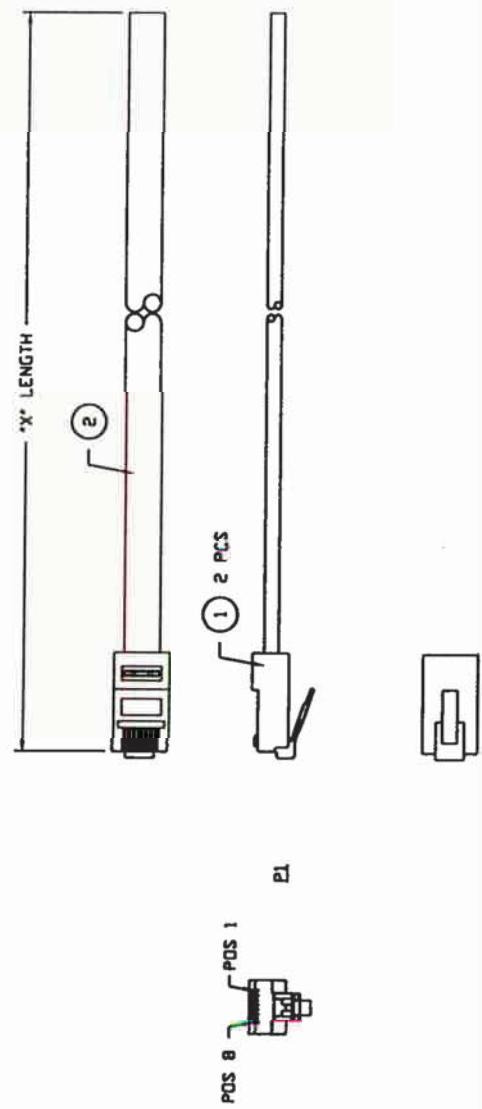

CUSTOMER APPROVAL
 ENGR. SIGN *Math Americk*
 DATE: 4-12-99

H3881-25-ND
 H3881-14-ND
 H3881-07-ND

488-298-522-D	25.0 FT ± 4.0 IN 7.62 M ± 101.6 MM
488-148-522-D	14.0 FT ± 3.0 IN 4.27 M ± 76.2 MM
488-078-522-D	7.0 FT ± 2.0 IN 2.13 M ± 50.8 MM

PART NUMBER I/O INTERCONNECT		LENGTH *X*
I/O INTERCONNECT SANTA ANA, CALIFORNIA		
TITLE 8P8P MODULAR TO OPEN END WHITE, CABLE ASSEMBLY	PART NO. 488-XXB-522-D	REV. XI
DRAWN CUSTOMER	PART NO. 488-XXB-522-D	REV. XI
DATE/PLD	CUSTOMER DIGI KEY	REV. XI
SA	SCALE NONE	SHEET 1 OF 1

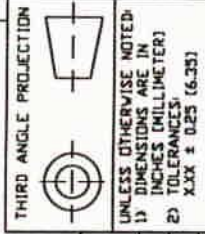

- NOTES: UNLESS OTHERWISE SPECIFIED.
- CABLE TO BE BUNDLED AND TWIST TIED.
 - TEST CABLE FOR ALL OPENS & SHORTS.
 - PACKAGE CABLE ASSEMBLY INDIVIDUALLY IN PLASTIC BAG. PACKAGE INDIVIDUAL BAG PER LOT NUMBER QUANTITIES.

2	*X*	120-810-020	MODULAR CABLE, 26 AVG (7/34) BARE COPPER, 8 CONDUCTOR, UNSHIELDED, WHITE PVC.
1	1 PC	325-881-50X	CONNECTOR, MODULAR PLUG, 8 POSITION, 8 CONDUCTOR, 50U" AU, FLAT TYPE EXIT.
ITEM	QTY	MFG.	DESCRIPTION
		IOI PART NO.	

CABLE ASSEMBLY PARTS LIST

488-148-515-D	121-810-022	14.0 FT (4.3 M)	50.0 IN (1270.0 MM)	WHITE
488-148-514-D	121-810-012	14.0 FT (4.3 M)	50.0 IN (1270.0 MM)	BLACK
488-148-513-D	121-810-002	14.0 FT (4.3 M)	50.0 IN (1270.0 MM)	SILVER SATIN
488-108-512-D	121-810-021	10.0 FT (3.0 M)	42.0 IN (1066.8 MM)	WHITE
488-108-511-D	121-810-011	10.0 FT (3.0 M)	42.0 IN (1066.8 MM)	BLACK
488-108-510-D	121-810-001	10.0 FT (3.0 M)	42.0 IN (1066.8 MM)	SILVER SATIN
488-078-515-D	121-810-020	7.0 FT (2.1 M)	28.0 IN (711.2 MM)	WHITE
488-078-514-D	121-810-010	7.0 FT (2.1 M)	28.0 IN (711.2 MM)	BLACK
488-078-513-D	121-810-000	7.0 FT (2.1 M)	28.0 IN (711.2 MM)	SILVER SATIN
488-058-512-D	121-810-023	5.0 FT (1.5 M)	22.0 IN (558.8 MM)	WHITE
488-058-511-D	121-810-013	5.0 FT (1.5 M)	22.0 IN (558.8 MM)	BLACK
488-058-510-D	121-810-003	5.0 FT (1.5 M)	22.0 IN (558.8 MM)	SILVER SATIN
101 PART NUMBER	101 CABLE PART NUMBER	EXTENDED LENGTH "X"	RETRACTED LENGTH "R"	

TABULATION BLOCK

NOTES: UNLESS OTHERWISE SPECIFIED.

1. TEST CABLE FOR ALL OPENS & SHORTS.
2. PACKAGE CABLE ASSEMBLY INDIVIDUALLY IN PLASTIC BAG. PACKAGE INDIVIDUAL BAG PER LOT NUMBER QUANTITIES.

CUSTOMER APPROVAL
 ENGR. SIGN Matt Lerner
 DATE: 4-13-99

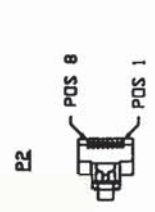
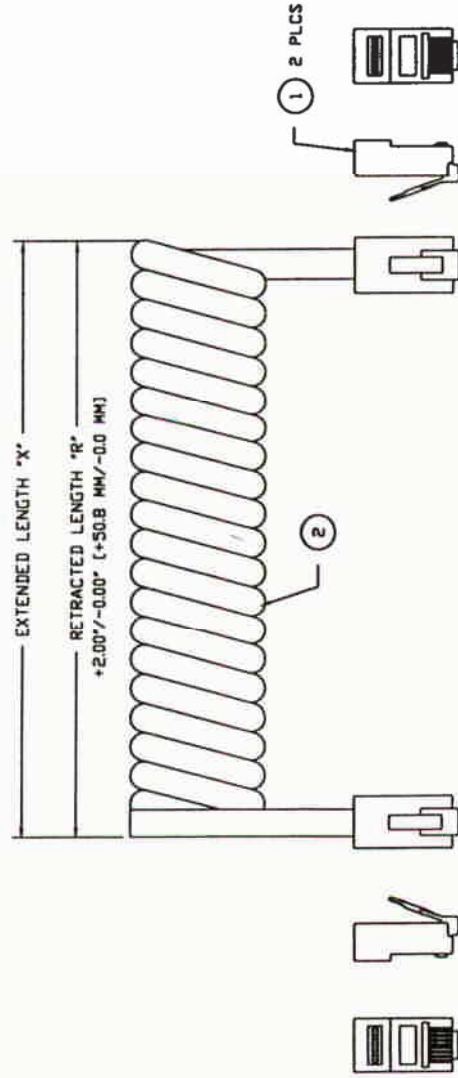

POS	WIRE COLOR
1	GRAY
2	ORANGE
3	BLACK
4	RED
5	GREEN
6	YELLOW
7	BLUE
8	BROWN

THIRD ANGLE PROJECTION

UNLESS OTHERWISE NOTED, DIMENSIONS ARE IN INCHES (MILLIMETER) TOLERANCES: .XXX ± 0.25 (6.35)

REV.	DATE
X1	03/26/99
X2	03/29/99

2	*X* FT	101	SEE "TABULATION BLOCK"	MODULAR COIL CABLE, 26 AVG (7/34) BARE COPPER, 8 CONDUCTOR, UNSHIELDED, PVC JACKET, (SEE TABULATION BLOCK FOR COLOR).
1	2 PCS	101	325-881-50X	CONNECTOR, MODULAR PLUG, 8 POSITION, 8 CONDUCTOR, 50U AU, FLAT TYPE EXIT.
ITEM	QTY	MFG.	101 PART NO.	DESCRIPTION

CABLE ASSEMBLY PARTS LIST

I/O INTERCONNECT
 SANTA ANA, CALIFORNIA

SCALE	NONE	SHEET	1	OF	1
-------	------	-------	---	----	---

THESE DRAWINGS AND SPECIFICATIONS ARE THE SOLE PROPERTY OF I/O INTERCONNECT INC., U.S.A. AND SHALL NOT BE REPRODUCED, COPIED, OR USED IN ANY MANNER WITHOUT THE PRIOR WRITTEN CONSENT OF I/O INTERCONNECT INC. OR ITS AFFILIATED SUBSIDIARIES.

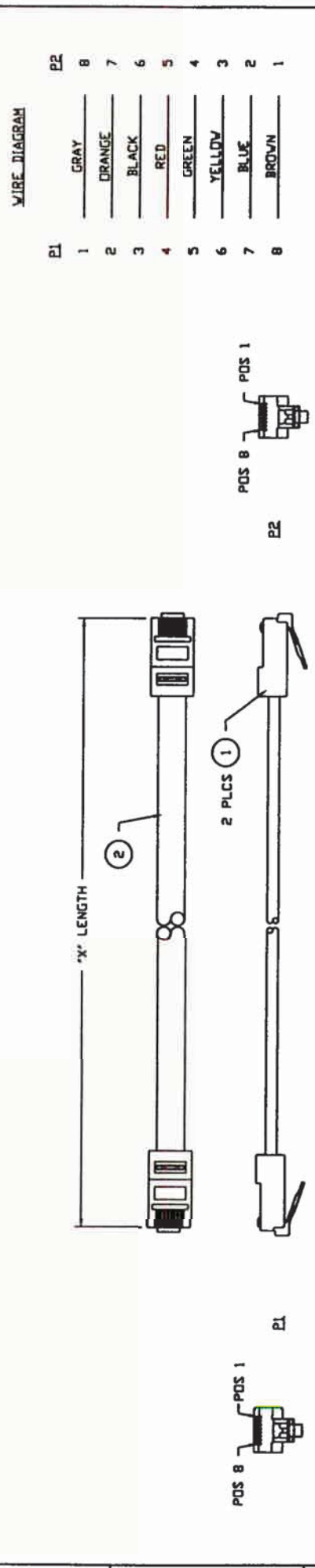

CUSTOMER APPROVAL
 ENGR. SIGN *Matt Lomas*
 DATE: 4-12-99

- NOTES: UNLESS OTHERWISE SPECIFIED.
- CABLE TO BE BUNDLED AND TWIST TIED.
 - TEST CABLE FOR ALL OPENS & SHORTS.
 - PACKAGE CABLE ASSEMBLY INDIVIDUALLY IN PLASTIC BAG. PACKAGE INDIVIDUAL BAG PER LOT NUMBER QUANTITIES.

488-258-512-D	25.0 FT ± 4.0 IN 7.62 M ± 101.6 MM
488-148-512-D	14.0 FT ± 3.0 IN 4.27 M ± 76.2 MM
488-078-512-D	7.0 FT ± 2.0 IN 2.13 M ± 50.8 MM
PART NUMBER I/O INTERCONNECT	LENGTH "X"

REV. 1	DATE	BY
X1		

REV. 1	DATE	BY
X1		

REV. 1	DATE	BY
X1		

REV. 1	DATE	BY
X1		

120-810-020	MODULAR CABLE, 26 AVG (7/34) BARE COPPER, 8 CONDUCTOR, UNSHIELDED, WHITE PVC.
325-881-50X	CONNECTOR, MODULAR PLUG, B POSITION, 8 CONDUCTOR, 50U" AU, FLAT TYPE EXIT.
101 PART NO.	DESCRIPTION

CABLE ASSEMBLY PARTS LIST

THESE DRAWINGS AND SPECIFICATIONS ARE THE SOLE PROPERTY OF I/O INTERCONNECT INC., U.S.A. AND SHALL NOT BE REPRODUCED, COPIED, OR USED IN ANY MANNER WITHOUT THE PRIOR WRITTEN CONSENT OF I/O INTERCONNECT INC. OR ITS AFFILIATED SUBSIDIARIES.

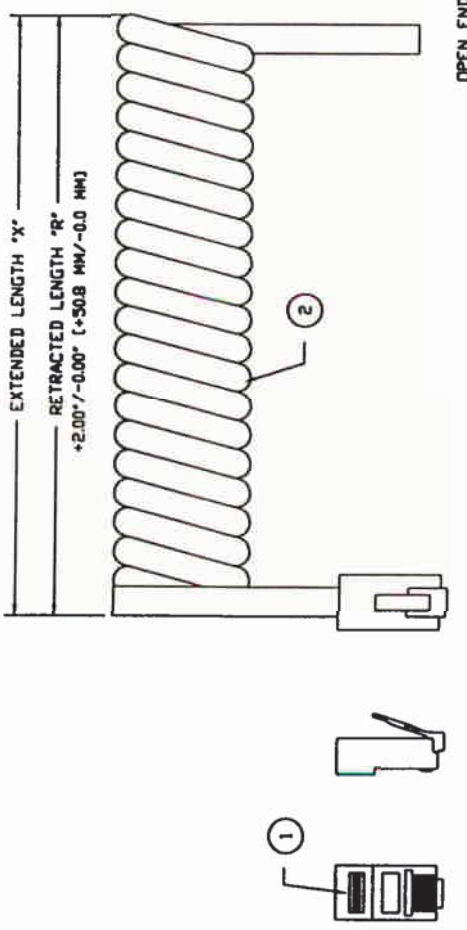

WIRE DIAGRAM

OPEN END

PL 1	GRAY
2	ORANGE
3	BLACK
4	RED
5	GREEN
6	YELLOW
7	BLUE
8	BROWN

CUSTOMER APPROVAL

ENGR. SIGN Y. Matt Amur

DATE: 4-13-99

- NOTES: UNLESS OTHERWISE SPECIFIED.
1. TEST CABLE FOR ALL OPENS & SHORTS.
 2. PACKAGE CABLE ASSEMBLY INDIVIDUALLY IN PLASTIC BAG. PACKAGE INDIVIDUAL BAG PER LOT NUMBER QUANTITIES.

488-148-525-D	121-810-022	14.0 FT (4.3 M)	50.0 IN (1270.0 MM)	WHITE
488-148-524-D	121-810-012	14.0 FT (4.3 M)	50.0 IN (1270.0 MM)	BLACK
488-148-523-D	121-810-002	14.0 FT (4.3 M)	50.0 IN (1270.0 MM)	SILVER SATIN
488-108-522-D	121-810-021	10.0 FT (3.0 M)	42.0 IN (1066.8 MM)	WHITE
488-108-521-D	121-810-011	10.0 FT (3.0 M)	42.0 IN (1066.8 MM)	BLACK
488-108-520-D	121-810-001	10.0 FT (3.0 M)	42.0 IN (1066.8 MM)	SILVER SATIN
488-078-525-D	121-810-020	7.0 FT (2.1 M)	28.0 IN (711.2 MM)	WHITE
488-078-524-D	121-810-010	7.0 FT (2.1 M)	28.0 IN (711.2 MM)	BLACK
488-078-523-D	121-810-000	7.0 FT (2.1 M)	28.0 IN (711.2 MM)	SILVER SATIN
488-058-522-D	121-810-023	5.0 FT (1.5 M)	22.0 IN (558.8 MM)	WHITE
488-058-521-D	121-810-013	5.0 FT (1.5 M)	22.0 IN (558.8 MM)	BLACK
488-058-520-D	121-810-003	5.0 FT (1.5 M)	22.0 IN (558.8 MM)	SILVER SATIN
IOI PART NUMBER	IOI CABLE PART NUMBER	EXTENDED LENGTH "X"	RETRACTED LENGTH "R"	

TABULATION BLOCK

THIRD ANGLE PROJECTION

UNLESS OTHERWISE NOTED, DIMENSIONS ARE IN INCHES (MM LITER). TOLERANCES: X.XX ± 0.25 (6.35)

MODULAR COIL CABLE, 26 AVG (7/34) BARE COPPER, 8 CONDUCTOR, UNSHIELDED, PVC JACKET, (SEE TABULATION BLOCK FOR COLOR).

CONNECTOR, MODULAR PLUG, 8 POSITION, 8 CONDUCTOR, 50U Au, FLAT TYPE EXIT.

DESCRIPTION

CABLE ASSEMBLY PARTS LIST

2	"X" FT	IOI	SEE "TABULATION BLOCK"
1	1 PC	IOI	325-881-50X
ITEM	QTY	MFG.	IOI PART NO.

SCALE NONE SHEET 1 OF 1

I/O INTERCONNECT SANTA ANA, CALIFORNIA

899C COIL CABLE TO OPEN END, CABLE ASSEMBLY

PART NO. 488-XXB-52X-D

DWG NO. 488-XXB-52X-D

CUSTOMER DIGI KEY

REV. X2