



Chipsmall Limited consists of a professional team with an average of over 10 year of expertise in the distribution of electronic components. Based in Hongkong, we have already established firm and mutual-benefit business relationships with customers from,Europe,America and south Asia,supplying obsolete and hard-to-find components to meet their specific needs.

With the principle of “Quality Parts,Customers Priority,Honest Operation,and Considerate Service”,our business mainly focus on the distribution of electronic components. Line cards we deal with include Microchip,ALPS,ROHM,Xilinx,Pulse,ON,Everlight and Freescale. Main products comprise IC,Modules,Potentiometer,IC Socket,Relay,Connector.Our parts cover such applications as commercial,industrial, and automotives areas.

We are looking forward to setting up business relationship with you and hope to provide you with the best service and solution. Let us make a better world for our industry!



## Contact us

Tel: +86-755-8981 8866 Fax: +86-755-8427 6832

Email & Skype: info@chipsmall.com Web: www.chipsmall.com

Address: A1208, Overseas Decoration Building, #122 Zhenhua RD., Futian, Shenzhen, China



THIS DRAWING IS UNPUBLISHED  
 RELEASED FOR PUBLICATION  
 - , 2017.  
 © COPYRIGHT - 2017 by TE Connectivity Germany GmbH  
 ALL RIGHTS RESERVED.

REVISIONS				
P	LTR	DESCRIPTION	DATE	APVD
	A1	New Release	09MAR2017	GCM/MSZ

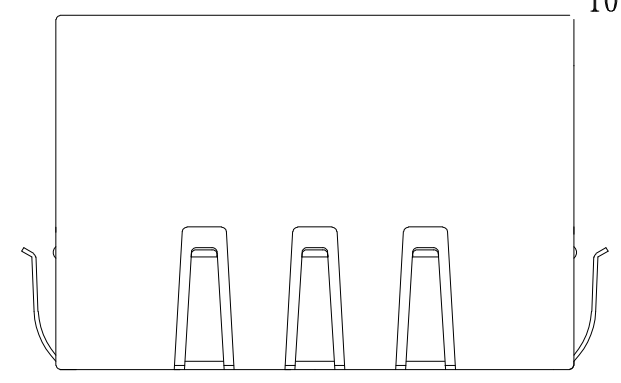
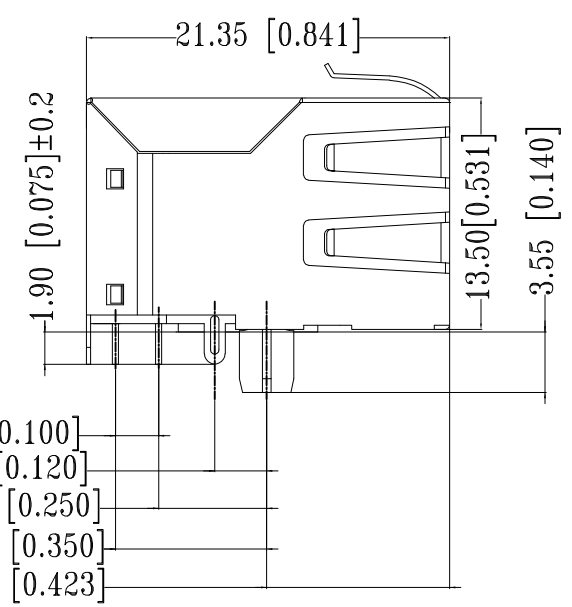
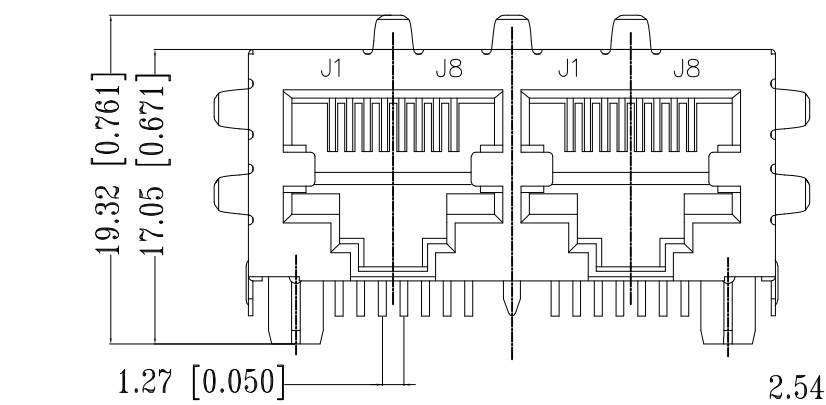
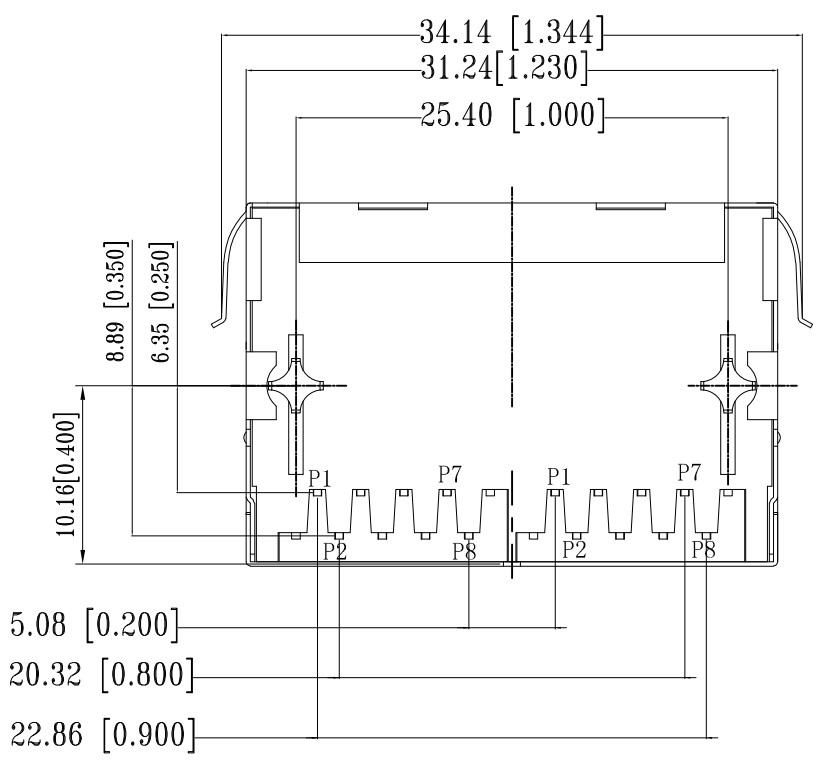

- △ CONNECTOR MATERIAL:  
 HOUSING: LCP BLACK UL94 V-0  
 INSERT: LCP BLACK UL94 V-0  
 SHIELD: BRASS  
 SHIELD PLATING: NICKEL  
 CONTACT: COPPER ALLOY  
 CONTACT PLATING: SELECTIVE GOLD, MIN. 0.76µm (30µinch) IN CONTACT AREA  
 OVER MIN. 1.27µm (50µinch) NICKEL  
 SOLDER PIN PLATING: 3.05µm (120µinch) TIN OVER 1.02µm (40µinch) NICKEL  
 OVER ALL  
 SHIELDING PIN PLATING: NICKEL
- 2 PIN NOT ELECTRICALLY CONNECTED MAYBE OMITTED SEE ELECTRICAL CIRCUIT DIAGRAM FOR OMITTED PINS
- 3 RJ45 CAVITIES CONFORM TO FCC RULES AND REGULATION PART 68
- 4 THE PART IS RECOMMENDED FOR REFLOW SOLDERING PROCESS PEAK SOLDERING: TEMPERATURE MAX. +260° C, MAX. 10s
- 5 OPERATING TEMPERATURE: T= -40° C TO +85° C
- 6 STORAGE TEMPERATURE: T= -40° C TO +85° C
- △ UNLESS OTHERWISE SPECIFIED, SEE TABLE FOR ALL DIMENSIONS TOLERANCES
- 8 JACK CONFIGURATION: 1 x 2  
 TAB DIRECTION: DOWN
- 9 PACKAGING: TRAY ACCORDING TO PACKAGING SPECIFICATION 107-18116

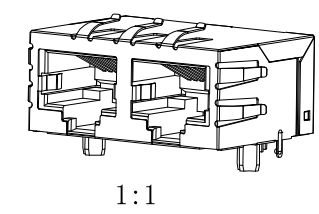

TABLE OF TOLERANCE (mm)	
RANGE	TOLERANCE
0-10	±0.15
>10-40	±0.25
>40-70	±0.30
>70	±0.40

THIS DRAWING IS A CONTROLLED DOCUMENT.		DWN GANESH C M 27AUG2016	<b>STE</b> TE Connectivity	
DIMENSIONS: mm [INCHES]		CHK FRANZ MUELLER 27AUG2016		
TOLERANCES UNLESS OTHERWISE SPECIFIED: 0 PLC ± - 1 PLC ± - 2 PLC ± - 3 PLC ± - 4 PLC ± - ANGLES ± -		APVD MARTIN SZELAG 27AUG2016	NAME RJ45 JACK INT.MAG. 10/100 1x2	
MATERIAL		PRODUCT SPEC 108-94552	SIZE A3	CAGE CODE 00779
FINISH		APPLICATION SPEC 114-94447	DRAWING NO C-5-2301996-2	RESTRICTED TO -
CUSTOMER DRAWING		WEIGHT -	SCALE 3:1	SHEET 1 OF 3
			REV A1	

REVISIONS

P	LTR	DESCRIPTION	DATE	DWN	APVD
-	-	SEE SHEET 1	-	-	-

SUGGESTED PCB LAYOUT

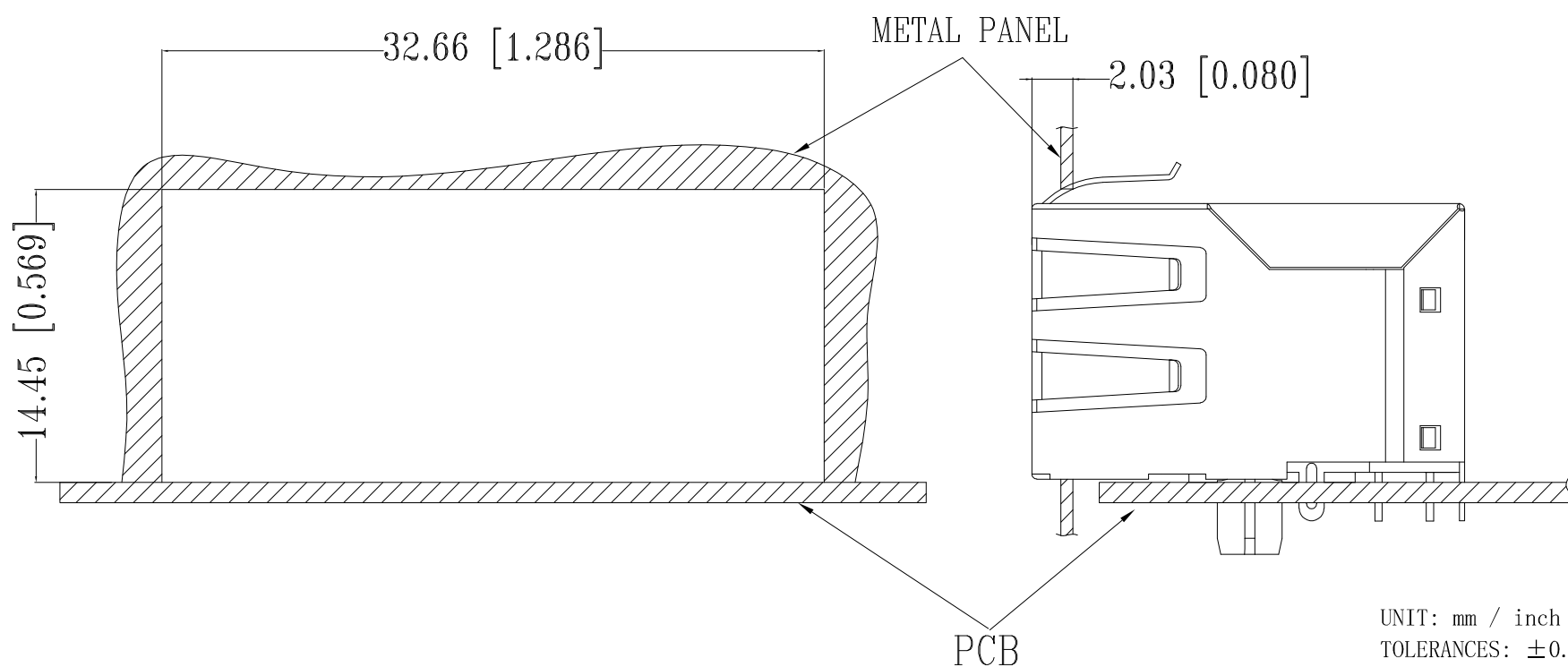
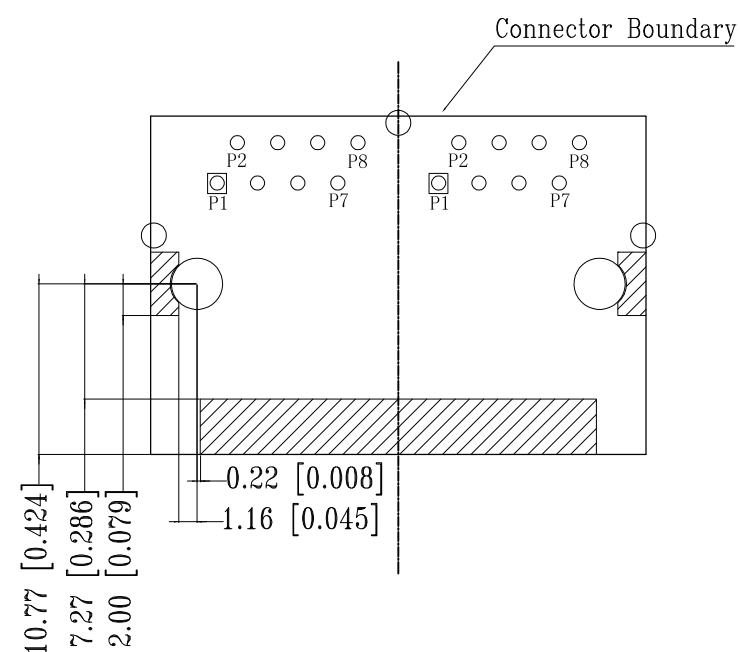
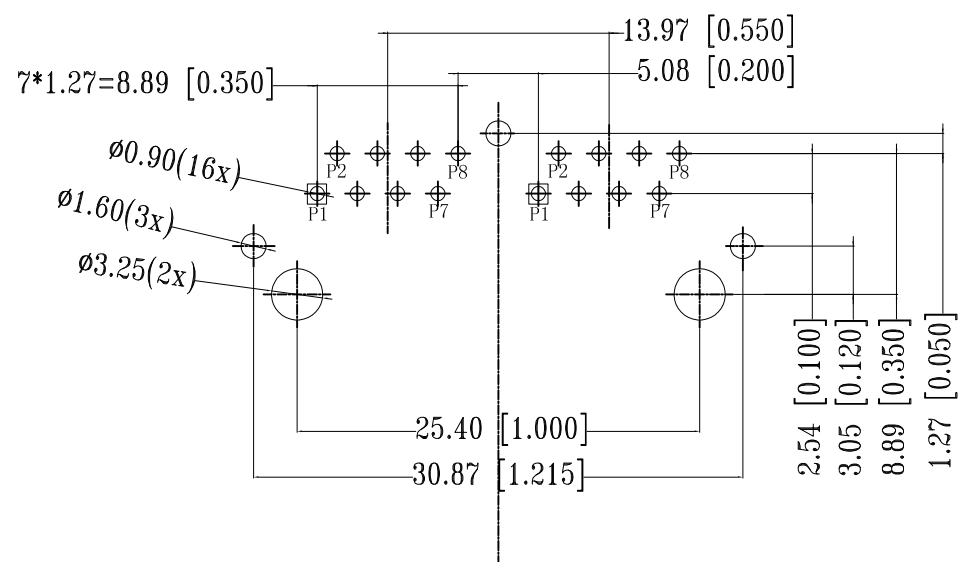

UNIT: mm / inch  
TOLERANCES: ±0.10 / 0.004

THIS DRAWING IS A CONTROLLED DOCUMENT.		DWN GANESH C M 27AUG2016			
DIMENSIONS: mm [INCHES]		CHK FRANZ MUELLER 27AUG2016			
TOLERANCES UNLESS OTHERWISE SPECIFIED:		APVD MARTIN SZELAG 27AUG2016	NAME RJ45 JACK INT.MAG. 10/100 1x2		
<ul style="list-style-type: none"> <li>0 PLC ± -</li> <li>1 PLC ± -</li> <li>2 PLC ± -</li> <li>3 PLC ± -</li> <li>4 PLC ± -</li> <li>ANGLES ± -</li> </ul>		PRODUCT SPEC 108-94552	SIZE A3		
MATERIAL 1		FINISH 1	APPLICATION SPEC 114-94447	CAGE CODE 00779	DRAWING NO C-5-2301996-2
		WEIGHT 0	RESTRICTED TO -		
CUSTOMER DRAWING			SCALE 3:1	SHEET 2 of 3	REV A1

REVISIONS

P	LTR	DESCRIPTION	DATE	DWN	APVD
-	-	SEE SHEET 1	-	-	-

ELECTRICAL CIRCUIT DIAGRAM

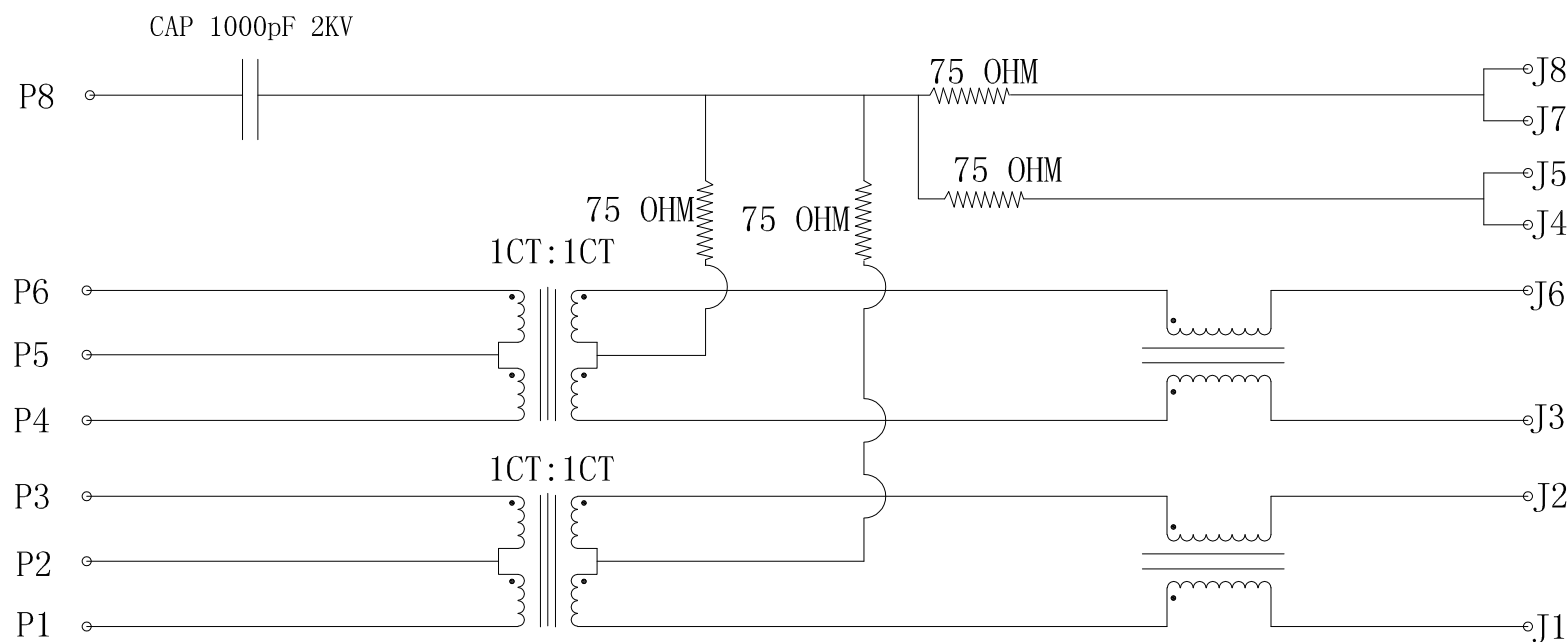

- 1.0 Turn Ratio @100KHz: (P1~P3):(J1~J2) = 1:1±2%  
(P4~P6):(J3~J6) = 1:1±2%
- 2.0 Primary Inductance: 350uH MIN @100KHZ,0.1V 8mA DC BIAS
- 3.0 DC Resistance: 1.2 OHMS MAX
- 4.0 Insertion Loss: 1-100MHz -1.2dB MAX
- 5.0 Return Loss: 1-30MHz -16dB MIN  
30-60MHz -12dB MIN  
60-80MHz -10dB MIN
- 6.0 CROSS TALK: 1-100MHz -30dB MIN
- 7.0 COMMON TO COMMON MODE ATTENUATION: 1-100MHz -30dB MIN
- 8.0 Isolation: PHY Side to Line Side: 2250VDC

5-2301996-2  
WWYY-xxxx

**TE**

FCC

CONTROL CODE  
DATE CODE  
"0213"  
YY-YEAR  
WW-WEEK

THIS DRAWING IS A CONTROLLED DOCUMENT.		DWN GANESH C M 27AUG2016	<b>TE</b> TE Connectivity		
DIMENSIONS: mm [INCHES]		CHK FRANZ MUELLER 27AUG2016			
TOLERANCES UNLESS OTHERWISE SPECIFIED:		APVD MARTIN SZELAG 27AUG2016	NAME RJ45 JACK INT.MAG. 10/100 1x2		
0 PLC ± - 1 PLC ± - 2 PLC ± - 3 PLC ± - 4 PLC ± - ANGLES ± -		PRODUCT SPEC 108-94552	SIZE A3		
MATERIAL 1		FINISH 1	APPLICATION SPEC 114-94447	CAGE CODE 00779	DRAWING NO C-5-2301996-2
CUSTOMER DRAWING			RESTRICTED TO -	SCALE 3:1	SHEET 3 OF 3
			WEIGHT 0	REV A1	