



Chipsmall Limited consists of a professional team with an average of over 10 year of expertise in the distribution of electronic components. Based in Hongkong, we have already established firm and mutual-benefit business relationships with customers from,Europe,America and south Asia,supplying obsolete and hard-to-find components to meet their specific needs.

With the principle of “Quality Parts,Customers Priority,Honest Operation,and Considerate Service”,our business mainly focus on the distribution of electronic components. Line cards we deal with include Microchip,ALPS,ROHM,Xilinx,Pulse,ON,Everlight and Freescale. Main products comprise IC,Modules,Potentiometer,IC Socket,Relay,Connector.Our parts cover such applications as commercial,industrial, and automotives areas.

We are looking forward to setting up business relationship with you and hope to provide you with the best service and solution. Let us make a better world for our industry!



## Contact us

Tel: +86-755-8981 8866 Fax: +86-755-8427 6832

Email & Skype: info@chipsmall.com Web: www.chipsmall.com

Address: A1208, Overseas Decoration Building, #122 Zhenhua RD., Futian, Shenzhen, China



## Unshielded Modular Plugs (Continued)

### 6-Position Long Body

Photo-109865-4

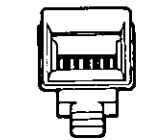
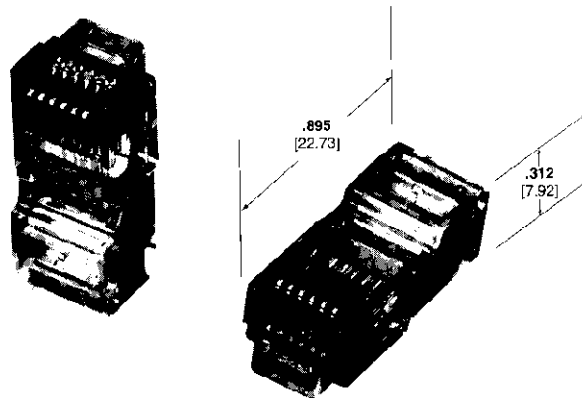

Flat Oval Cable

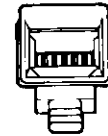

Round Cable

Description	Plug Part Numbers					
	Strip	10,000/Box	1,000/Box	500/Box	100/Box	25/Bag
6/6-Position Long Flat Oval Solid Line	555426-1	N/A	N/A	5-555426-3	5-555426-3	5-555426-4
6/6-Position Long Flat Oval Stranded Line	555176-1	N/A	N/A	5-555176-3	5-555176-3	N/A
6/6-Position Long Round Stranded Line	555177-1	N/A	N/A	5-555177-3	5-555177-3	N/A

### 8-Position

Photo-109865-2

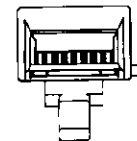
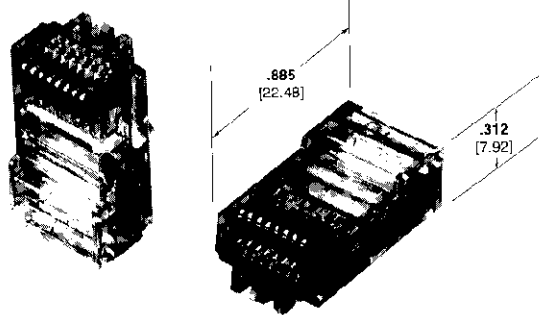

Flat Oval Cable

Optional Key

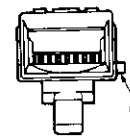

Round Cable

Optional Key

Description	Plug Part Numbers					
	Strip	10,000/Box	1,000/Box	500/Box	100/Box	25/Bag
8/8-Position Flat Oval Solid Line	554720-1	5-554720-1	N/A	5-554720-2	5-554720-3	5-554720-4
8/8-Position Flat Oval Stranded Line	554739-1	5-554739-1	N/A	5-554739-2	5-554739-3	5-554739-4
8/8-Position Round Solid Line	N/A	5-557315-1	N/A	5-557315-2	5-557315-3	5-557315-4
8/8-Position Round Stranded Line	554169-1	5-554169-1	N/A	5-554169-2	<b>5-554169-3</b>	<b>5-554169-4</b>
8/8-Position Small Round Cable Stranded Line	N/A	5-557961-1	N/A	5-557961-2	5-557961-3	N/A
8/8-Position Small Round Cable Solid Line	N/A	N/A	N/A	5-569215-2	N/A	N/A
8/8-Position Flat Oval Small Solid Conductor Line*	N/A	N/A	N/A	5-557972-2	5-557972-3	N/A
8/8-Position Flat Oval Small Stranded Conductor Line*	N/A	N/A	N/A	5-557973-2	5-557973-3	N/A
8/8-Position Keyed Flat Oval Solid Line	555417-1	N/A	N/A	N/A	5-555417-2	5-555417-4
8/8-Position Keyed Flat Oval Stranded Line	554743-1	N/A	N/A	5-554743-2	5-554743-3	5-554743-4
8/8-Position Keyed Round Stranded Line	554170-1	N/A	N/A	5-554170-2	5-554170-3	5-554170-4

\*Small conductor products are for .029 - .034 [.737 - .864] OD conductors. Small Conductor product housings are tinted blue to differentiate from Standard Product.  
Standard products cover .029 - .039 [.737 - .991] when a small conductor product does not exist.

## Unshielded Modular Plugs (Continued)

Photo-109865-3

### 10-Position

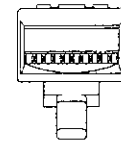
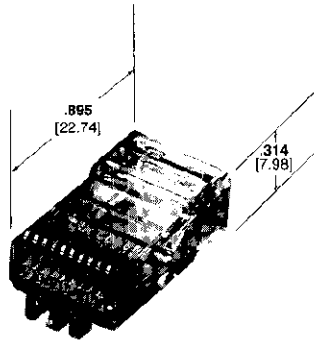
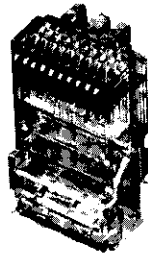

Round Cable

Description	Plug Part Numbers	
	500/Box	100/Box
10/10-Position Round Stranded Line	5-557963-2	5-557963-3
10/10-Position Small Round Stranded	5-406938-2	N/A

### 4-Position Handset

Photo-109865-7

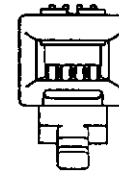
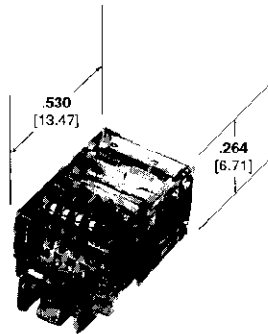
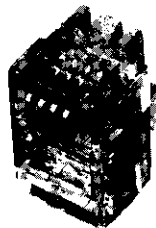

Flat Oval Cable

Description	Plug Part Numbers					
	Strip	10,000/Box	1,000/Box	500/Box	100/Box	25/Bag
4-Position Flat Oval Solid	N/A	N/A	5-556200-2	N/A	N/A	N/A
4-Position Flat Oval Stranded	641334-1	5-641334-1	5-641334-2	N/A	5-641334-3	5-641334-7

### 6-Position with Offset Latch

Photo-109865-6

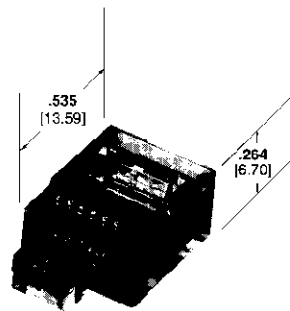
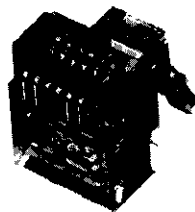

Description	Plug Part Numbers					
	Strip	10,000/Box	1,000/Box	500/Box	100/Box	25/Bag
6-Position Round Stranded Offset	555238-1	N/A	N/A	N/A	5-555238-2	5-555238-3
6 Position Flat Oval Solid Offset	555236-1	N/A	5-555236-1	N/A	5-555236-2	5-555236-3
6-Position Flat Oval Stranded Offset	555237-1	N/A	5-555237-1	N/A	5-555237-2	5-555237-3
6-Position Wide Flat Oval Stranded Offset	557345-1	N/A	5-557345-1	N/A	5-557345-2	5-557345-3

**Note:** Offset latch product conforms to FCC requirements except for latch location.