



Chipsmall Limited consists of a professional team with an average of over 10 year of expertise in the distribution of electronic components. Based in Hongkong, we have already established firm and mutual-benefit business relationships with customers from,Europe,America and south Asia,supplying obsolete and hard-to-find components to meet their specific needs.

With the principle of “Quality Parts,Customers Priority,Honest Operation,and Considerate Service”,our business mainly focus on the distribution of electronic components. Line cards we deal with include Microchip,ALPS,ROHM,Xilinx,Pulse,ON,Everlight and Freescale. Main products comprise IC,Modules,Potentiometer,IC Socket,Relay,Connector.Our parts cover such applications as commercial,industrial, and automotives areas.

We are looking forward to setting up business relationship with you and hope to provide you with the best service and solution. Let us make a better world for our industry!



## Contact us

Tel: +86-755-8981 8866 Fax: +86-755-8427 6832

Email & Skype: info@chipsmall.com Web: www.chipsmall.com

Address: A1208, Overseas Decoration Building, #122 Zhenhua RD., Futian, Shenzhen, China



SHAPE OF 2CKTS

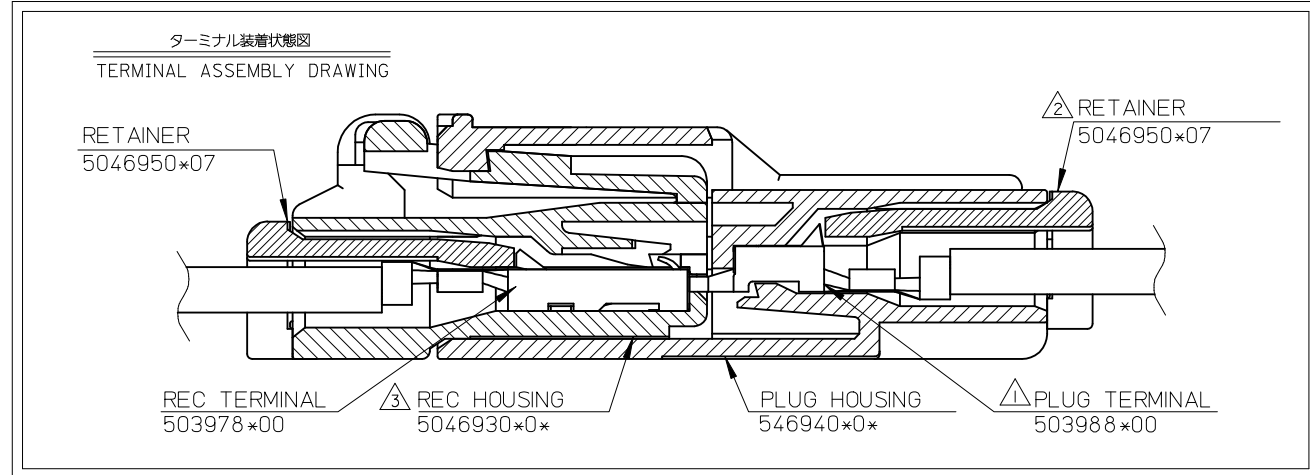
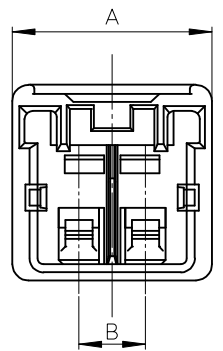
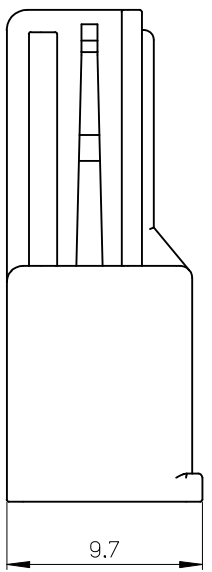
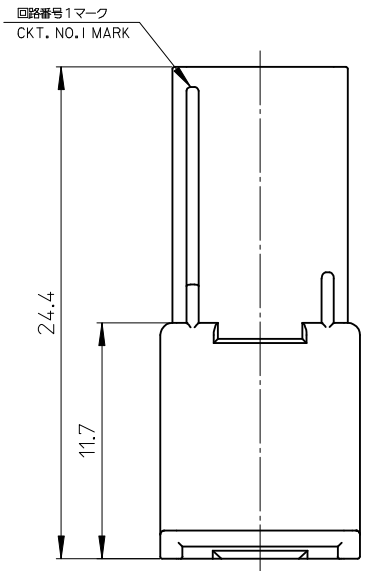
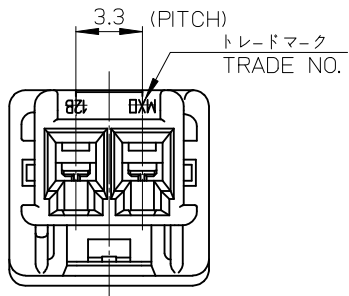

- 注記  
NOTES
- △ 適合ターミナル : 50398 シリーズ  
APPLICABLE TERMINAL : 50398 SERIES
  - △ 適合リテーナー : 504695 シリーズ  
APPLICABLE RETAINER : 504695 SERIES
  - △ 嵌合相手 : 504693 シリーズ  
MATE WITH : 504693 SERIES
4. 材質 :PBT (UL94V-0)  
MATERIAL :PBT(UL94V-0)

5. MATERIAL NO. は以下の内容を示す。  
MATERIAL NO. :  
504694 \*\*0\*
- |           |            |         |
|-----------|------------|---------|
| 極数<br>CKT | 色<br>COLOR |         |
| 0         | 自然色        | NATURAL |
| 1         | 黒          | BLACK   |
| 2         | 赤          | RED     |
| 3         | 黄          | YELLOW  |
| 4         | 青          | BLUE    |
| 5         | 桃          | PINK    |
| 6         | 緑          | GREEN   |
| 8         | 橙          | ORANGE  |
| 9         | 紫          | VIOLET  |

6. コネクタの取扱いについては、AS-504693-001/002を参照。  
PLEASE REFER TO AS-504693-001/002.

16.5	23.1	6	504694060*	504694-0*0*
9.9	16.5	4	504694040*	
6.6	13.2	3	504694030*	
3.3	9.9	2	504694020*	
(B)	A	CKT.	MATERIAL NO.	MODEL NO.

REVISED EC NO: J2015-0993 DRWN: NUKITA CHKD: KASAKAWA APPR: NUKITA	GENERAL TOLERANCES (UNLESS SPECIFIED)			DIMENSION STYLE MM ONLY		SCALE 5:1	DESIGN UNITS METRIC	THIRD ANGLE PROJECTION
	0.25 UNDER	UNDER	±0.03	DRAWN BY MIKEDA01	DATE 2013/09/06	TITLE 3.3 W/W CONN. PLUG HOUSING		
	0.25 OVER	0.5 UNDER	±0.05	CHECKED BY KASAKAWA	DATE 2013/11/28			
	0.5 OVER	1.0 UNDER	±0.1	APPROVED BY NUKITA	DATE 2013/12/03			
	1.0 OVER	10 UNDER	±0.2	MATERIAL NO.	DOCUMENT NO.	SHEET NO.		
10 OVER	30 UNDER	±0.25	SEE CHART		SD-504694-001			
30 OVER		±0.3	THIS DRAWING CONTAINS INFORMATION THAT IS PROPRIETARY TO MOLEX INCORPORATED AND SHOULD NOT BE USED WITHOUT WRITTEN PERMISSION					
	ANGULAR	±1 °						
	DRAFT WHERE APPLICABLE MUST REMAIN WITHIN DIMENSIONS							

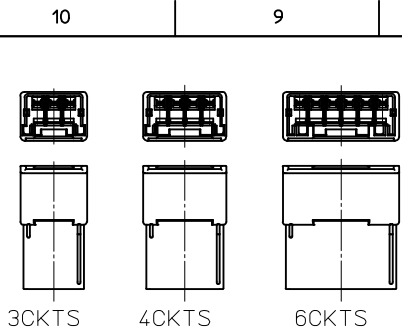

VIEW OF 3,4,6CKTS  
(SCALE 1:1)

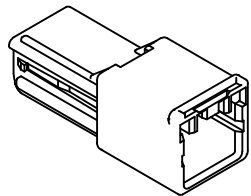

ISOMETRIC VIEW  
(SCALE 2:1)

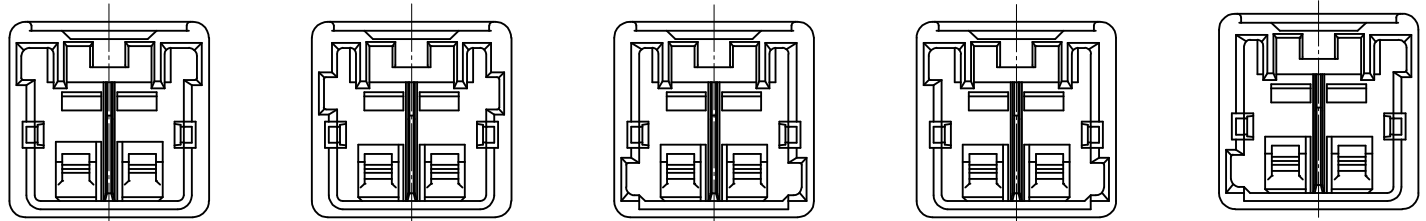

KEY TYPE:1 COLOR:NATURAL  
MATERIAL NO.:05046940200

KEY TYPE:2 COLOR:BLACK  
MATERIAL NO.:5046940201

KEY TYPE:3 COLOR:RED  
MATERIAL NO.:5046940202

KEY TYPE:4 COLOR:YELLOW  
MATERIAL NO.:5046940203

KEY TYPE:5 COLOR:BLUE  
MATERIAL NO.:5046940204

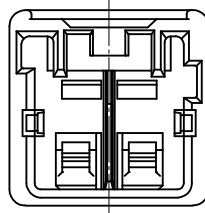

KEY TYPE:6 COLOR:PINK  
MATERIAL NO.:5046940205

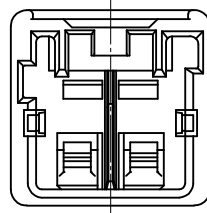

KEY TYPE:7 COLOR:GREEN  
MATERIAL NO.:5046940206

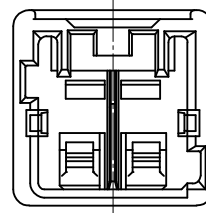

KEY TYPE:8 COLOR:ORANGE  
MATERIAL NO.:5046940208

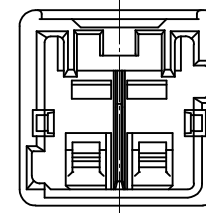

KEY TYPE:9 COLOR:VIOLET  
MATERIAL NO.:5046940209

MATING  
KEY TYPE & COLOR  
REFERENCE 2 CKTS

504693060*	5046950607	6					5046940604	5046940603	5046940602	5046940601	5046940600
504693040*	5046950407	4					5046940404	5046940403	5046940402	5046940401	5046940400
504693030*	5046950307	3								5046940301	5046940300
504693020*	5046950207	2	5046940209	5046940208	5046940206	5046940205	5046940204	5046940203	5046940202	5046940201	5046940200
MATE WITH	COMFORTABLE-RETAINER	CKT.	VIOLET	ORANGE	GREEN	PINK	BLUE	YELLOW	RED	BLACK	NATURAL

MATERIAL NO.

<b>REVISED</b> EC NO: J2015-0993 DRWN: ITO CHKD: KASAKAWA APPR: NUKITA	2015/01/29 2015/02/10 2015/02/12	GENERAL TOLERANCES (UNLESS SPECIFIED)		DIMENSION STYLE		SCALE	DESIGN UNITS	THIRD ANGLE PROJECTION
		0.25 UNDER UNDER ±0.03		MM ONLY		5:1	METRIC	
		0.25 OVER 0.5 UNDER ±0.05		DRAWN BY DATE		TITLE		
		0.5 OVER 1.0 UNDER ±0.1		MIKEDA01 2013/09/06		3.3 W/W CONN. PLUG HOUSING		
1.0 OVER 10 UNDER ±0.2		CHECKED BY DATE		KASAKAWA 2013/11/28		molex		
10 OVER 30 UNDER ±0.25		APPROVED BY DATE		NUKITA 2013/12/03		DOCUMENT NO.		
30 OVER ±0.3		MATERIAL NO.		SEE CHART		SD-504694-001		
ANGULAR ±1 °		DRAFT WHERE APPLICABLE MUST REMAIN WITHIN DIMENSIONS		SIZE A3		SHEET NO. 2 OF 2		