



Chipsmall Limited consists of a professional team with an average of over 10 year of expertise in the distribution of electronic components. Based in Hongkong, we have already established firm and mutual-benefit business relationships with customers from,Europe,America and south Asia,supplying obsolete and hard-to-find components to meet their specific needs.

With the principle of “Quality Parts,Customers Priority,Honest Operation,and Considerate Service”,our business mainly focus on the distribution of electronic components. Line cards we deal with include Microchip,ALPS,ROHM,Xilinx,Pulse,ON,Everlight and Freescale. Main products comprise IC,Modules,Potentiometer,IC Socket,Relay,Connector.Our parts cover such applications as commercial,industrial, and automotives areas.

We are looking forward to setting up business relationship with you and hope to provide you with the best service and solution. Let us make a better world for our industry!



Contact us

Tel: +86-755-8981 8866 Fax: +86-755-8427 6832

Email & Skype: info@chipsmall.com Web: www.chipsmall.com

Address: A1208, Overseas Decoration Building, #122 Zhenhua RD., Futian, Shenzhen, China



DuraClik™ SMT Wire-to-Board Connectors

2.00mm Pitch, Standard, ISL and TPA versions



Molex's expanded line of DuraClik™ connectors with terminal retainer options provides superior electrical contact reliability, mating retention and space savings compared to competitive versions for high-vibration and high-temperature applications. Available now in 2 to 15 circuits with both tin and gold plating options.

Features and Benefits

Inner positive-lock design	Provides secure mating and space savings; prevents latch breakage from wire tangling
"Click" sound when mated	Audible mating confirmation
Wide solder tabs designed and tested to SAE Automotive vibration standards	Provides secure PCB retention that can withstand upward pull force of 100N (10kgf) to meet automotive vibration requirements
Independent Secondary Lock (ISL) terminal retainer	Provides up to 50N of terminal retention force and helps position terminals while meeting stringent automotive requirements
Terminal Position Assurance (TPA) terminal retainer	Provides up to 20N of terminal retention force, and secures terminal positioning
Enclosed contact design	Protects contact against dust and debris; avoids tangling during harness assembly
Operating temperatures up to 125 degrees C (ISL and TPA versions)	Meet high-level automotive passenger compartment requirements
Open area for direct pick-and-place assembly	Supports automated board placement without the need for Kapton tape
Gold-plated terminal option	Higher durability for repeat mating cycling
Inertia lock (TPA version)	Requires higher insertion force during earlier part of mating in order to help confirm a secure connection

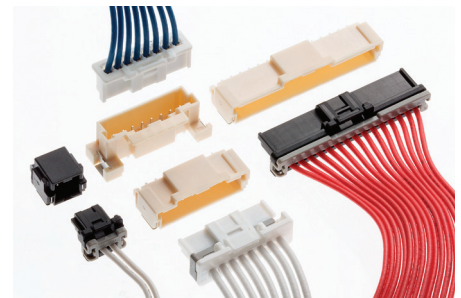

DuraClik Family

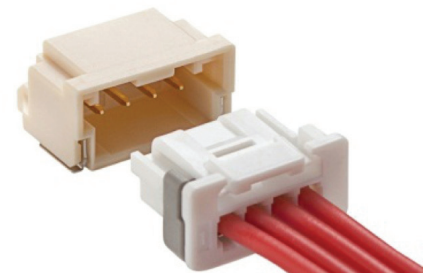

DuraClik ISL

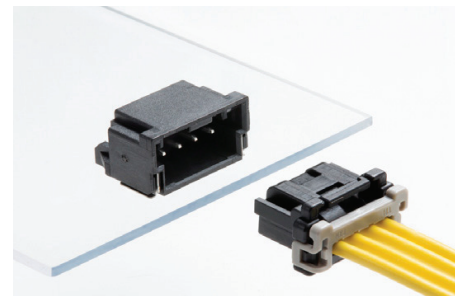

DuraClik TPA

Applications

Automotive Applications

- Steering wheel
- Wiper/blinker lever
- Shift lever
- Front/back headlights
- Inverter
- Air conditioner

Other Markets

- Lighting
- Electric bicycle
- Truck
- Crane
- Industrial/factory automation equipment



Front/Back Lights



Steering Wheel



Non-Automotive Transportation



Industrial/Factory Automation Equipment

DuraClik™ SMT Wire-to-Board Connectors

2.00mm Pitch, Standard, ISL and TPA versions

molex®

Additional Product Features

Secure PCB Retention For Anti-Vibration Resistance

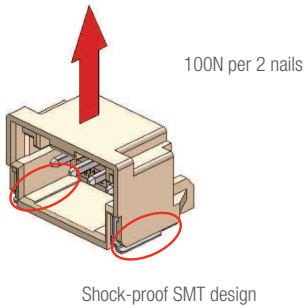

Wide solder tabs (nails) provide secure PCB retention that can withstand upward pull force of 100N (10kgf) to meet automotive anti-vibration requirements.

Crimp Terminal With Anti-Wire-Tangling Feature

Improved terminal top design prevents damage from wire tangling during shipping and handling

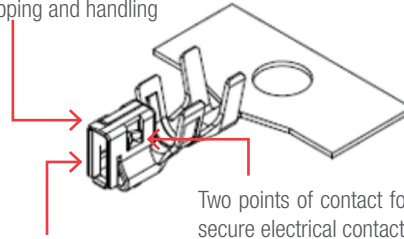

Closed terminal design protects contact against dust and debris.

Inner Positive Lock

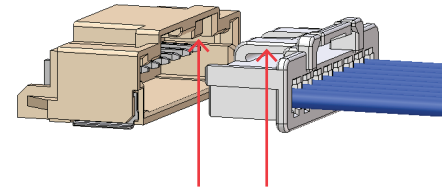

DuraClik ISL (Independent Secondary Lock)

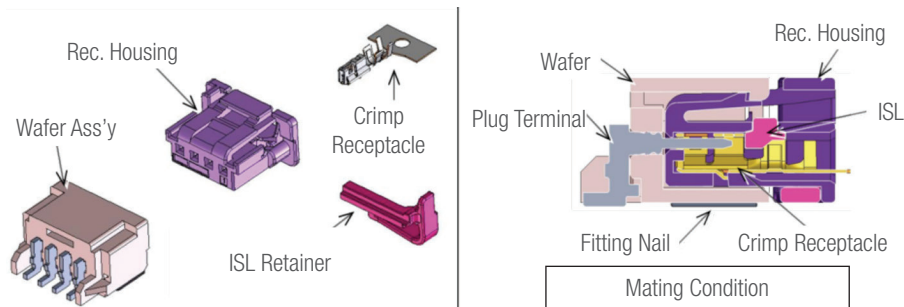

The Independent Secondary Lock (ISL) type terminal retainer provides up to 50N of retention force for superior terminal retention assurance.

DuraClik TPA (Terminal Position Assurance)

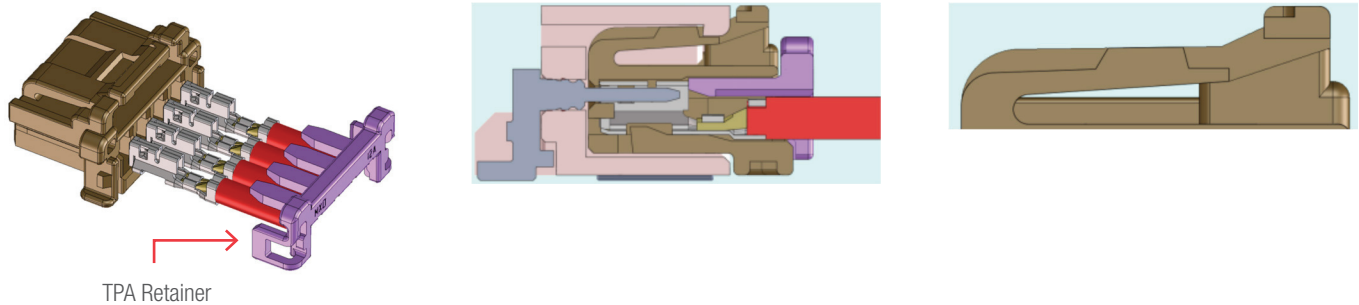

The Terminal Position Assurance (TPA) retainer helps position the terminal and provide up to 20N of terminal retention force.

DuraClik™ SMT Wire-to-Board Connectors



2.00mm Pitch, Standard, ISL and TPA versions

Specification

REFERENCE INFORMATION

Packaging:
 Header - Embossed tape
 Housing, Retainer - Bag
 Terminal - Reel
 Designed In: Millimeters
 RoHS: Yes
 Halogen Status: Low Halogen

ELECTRICAL

Voltage (max.): 125V
 Current (max.): 3.0A
 Contact Resistance: 10 milliohms max.
 Dielectric Withstanding Voltage: 500V AC
 Insulation Resistance: 1000 Megohm min.

PHYSICAL

Housing: Standard and ISL: PBT, TPA: PA
 Retainer: PBT
 Header Housing: Polyamide
 Header Terminal: Copper Alloy
 Terminal Contact: Phosphor Bronze
 Plating:
 Contact Area — Tin or Gold
 Solder Tail Area — Tin
 Underplating — Nickel
 Operating Temperature:
 -40 to +105°C (Standard)
 -40 to +125°C (ISL and TPA)

MECHANICAL

Contact Retention to Housing:
 Standard Version: 9.8N
 TPA Version: 20N
 ISL Version: 50N

Ordering Information

DuraClik Standard

Circuit Size	Order Number		
	Terminal	Housing, Natural	Housing, Black
2		502351-0200	502351-0201
3		502351-0300	502351-0301
4	50212-8000 Tin Plating 24 to 30 AWG	502351-0400	502351-0401
5		502351-0500	502351-0501
6		502351-0600	502351-0601
7		502351-0700	502351-0701
8	560085-0101 Tin Plating 22 to 26 AWG	502351-0800	502351-0801
9		502351-0900	—
10		502351-1000	—
11	56161-8081 Gold Plating 22 to 26 AWG	502351-1100	—
12		502351-1200	—
13		502351-1300	—
14		502351-1400	—
15		502351-1500	—

DuraClik TPA

Circuit Size	Order Number			
	Terminal	Retainer, Gray	Housing, Black	Housing, White
2		505152-0200	505151-0200	505151-0201
3		505152-0300	505151-0300	505151-0301
4		505152-0400	505151-0400	505151-0401
5		505152-0500	505151-0500	505151-0501
6	505153-8000 Tin Plating 22, 24 AWG	505152-0600	505151-0600	505151-0601
7		505152-0700	505151-0700	505151-0701
8		505152-0800	505151-0800	505151-0801
9		505152-0900	505151-0900	505151-0901
10	505487-8000 Gold Plating 22, 24 AWG	505152-1000	505151-1000	505151-1001
11		505152-1100	505151-1100	505151-1101
12		505152-1200	505151-1200	505151-1201
13		505152-1300	505151-1300	505151-1301
14		505152-1400	505151-1400	505151-1401
15		505152-1500	505151-1500	505151-1501

DuraClik ISL

Circuit Size	Order Number						
	Terminal	Retainer, Gray	Retainer, Black	Housing, White	Housing, Black	Housing, Red	Housing, Blue
2	560124-0101 Tin Plating AVSS 0.3mm ² , ISO FRLY-A 0.35mm ²	560125-0200	—	560123-0200	560123-0201	560123-0202	560123-0204
3		560125-0300	560125-0301	560123-0300	560123-0301	560123-0302	560123-0304
4		560125-0400	—	560123-0400	560123-0401	560123-0402	560123-0404
5		560125-0500	—	560123-0500	—	—	—
6	560124-0131 Gold Plating AVSS 0.3mm ² , ISO FRLY-A 0.35mm ²	560125-0600	560125-0601	560123-0600	560123-0601	560123-0602	560123-0604
8		560125-0800	—	560123-0800	560123-0801	560123-0802	560123-0804
10		560125-1000	—	560123-1000	—	—	—
12		560125-1200	—	560123-1200	—	—	—

* 9 Circuit will be available. Please contact to Molex for the details.

DuraClik Headers

Circuit Size	Order Number									
	Right Angle Header					Vertical Header				
	Natural, Tin	Black, Tin	Red, Tin	Blue, Tin	Natural, Gold	Natural, Tin	Black, Tin	Red, Tin	Blue, Tin	Natural, Gold
2	502352-0200	502352-0201	502352-0202	502352-0203	502352-0210	560020-0220	560020-0221	560020-0222	560020-0223	560020-0230
3	502352-0300	502352-0301	502352-0302	502352-0303	502352-0310	560020-0320	560020-0321	560020-0322	560020-0323	560020-0330
4	502352-0400	502352-0401	502352-0402	502352-0403	502352-0410	560020-0420	560020-0421	560020-0422	560020-0423	560020-0430
5	502352-0500	502352-0501	—	—	502352-0510	560020-0520	—	—	—	560020-0530
6	502352-0600	502352-0601	502352-0602	502352-0603	502352-0610	560020-0620	560020-0621	560020-0622	560020-0623	560020-0630
7	502352-0700	502352-0701	—	—	502352-0710	560020-0720	—	—	—	560020-0730
8	502352-0800	502352-0801	502352-0802	502352-0803	502352-0810	560020-0820	560020-0821	560020-0822	560020-0823	560020-0830
9	502352-0900	—	—	—	502352-0910	560020-0920	—	—	—	560020-0930
10	502352-1000	—	—	—	502352-1010	560020-1020	—	—	—	560020-1030
11	502352-1100	—	—	—	502352-1110	560020-1120	—	—	—	560020-1130
12	502352-1200	—	—	—	502352-1210	560020-1220	—	—	—	560020-1230
13	502352-1300	—	—	—	502352-1310	560020-1320	—	—	—	560020-1330
14	502352-1400	—	—	—	502352-1410	560020-1420	—	—	—	560020-1430
15	502352-1500	—	—	—	502352-1510	560020-1520	—	—	—	560020-1530

www.molex.com/link/duraclik.html