



Chipsmall Limited consists of a professional team with an average of over 10 year of expertise in the distribution of electronic components. Based in Hongkong, we have already established firm and mutual-benefit business relationships with customers from,Europe,America and south Asia,supplying obsolete and hard-to-find components to meet their specific needs.

With the principle of “Quality Parts,Customers Priority,Honest Operation,and Considerate Service”,our business mainly focus on the distribution of electronic components. Line cards we deal with include Microchip,ALPS,ROHM,Xilinx,Pulse,ON,Everlight and Freescale. Main products comprise IC,Modules,Potentiometer,IC Socket,Relay,Connector.Our parts cover such applications as commercial,industrial, and automotives areas.

We are looking forward to setting up business relationship with you and hope to provide you with the best service and solution. Let us make a better world for our industry!



Contact us

Tel: +86-755-8981 8866 Fax: +86-755-8427 6832

Email & Skype: info@chipsmall.com Web: www.chipsmall.com

Address: A1208, Overseas Decoration Building, #122 Zhenhua RD., Futian, Shenzhen, China



Neutralizing Ion Python and Hand Gun Operation and Maintenance



Made in the United States of America

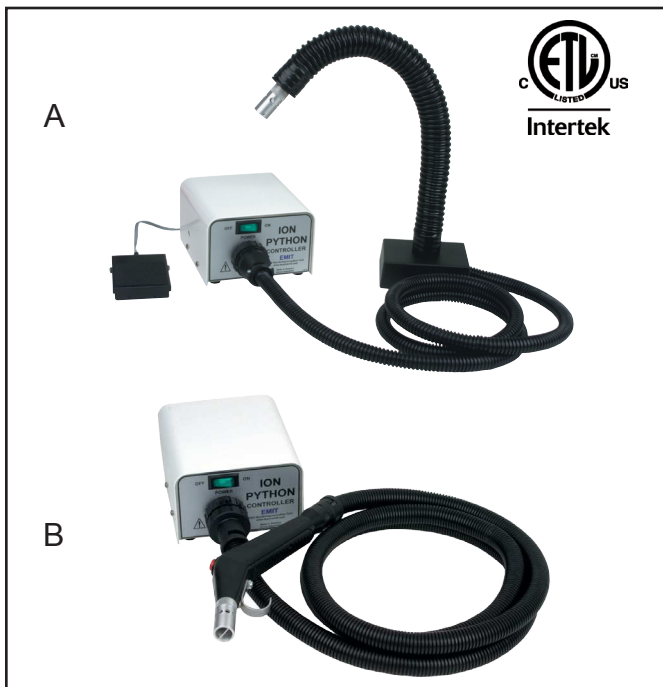

Figure 1. EMIT Ion Python Air Nozzles
 A. Ion Python (Controller and Foot Switch)
 B. Hand Gun (Controller with Hose)

Description

The EMIT Ion Python Air Nozzle and Neutralizing Hand Gun quickly and effectively neutralize bulk static charges and aid in controlling contamination by dislodging dust and debris attracted by static electricity. Attached to compressed air, the airflow may be easily adjusted from a gentle stream to a powerful blast. These units are designed for use in applications and areas where ElectroStatic Attraction contamination create manufacturing or handling problems (Ref: ESD Handbook TR 20.20 paragraph 5.3.6.5.2.4 Point of Use Ionization). The units meet or exceed the recommended technical requirements of ANSI/ESD S20.20 tested in accordance with ANSI/ESD S3.1.

The Ion Python Air Nozzle is designed for point-of-use fixed mounting applications, while the Ion Python Hand Gun is a more portable unit. The air hose of both units is designed to be easily disconnected or replaced by the user. Replacement nozzle/air hose assemblies for the Ion Python Air Nozzle are sold separately as EMIT Item #60335. Replacement nozzle/air hose assemblies for the Ion Python Hand Gun are sold separately as EMIT Item #60350.

Ionizers are useful in preventing electrostatic charge generation, ElectroStatic Discharge, ElectroStatic Attraction, as well as preventing equipment latch-up and safety related shock. ANSI/ESD S20.20 Paragraph 6.2.3.1 Protected Areas Requirement states: "Ionization or other charge mitigating techniques shall be used at the workstation to neutralize electrostatic fields on all process essential insulators if the electrostatic field is considered a threat." Ionization is used to neutralize charges on process necessary insulators and isolated semiconductors. Some

examples of process necessary insulators are: the PC board itself, plastic test stands, plastic housing where a PCB may be mounted, as well as computer monitor screens and regular cleaning wipes. Examples of floating or isolated conductors are: loaded PCB mounted in a stand where the pins are not contacting the dissipative workstation.

Air ionization can neutralize the static charge on insulated and isolated objects by producing separate charges in the molecules of the gases of the surrounding air. When an electrostatic charge is present on objects in the work environment, it will be neutralized by attracting opposite polarity charges from the ionized air. (Reference: IEC 61340-5-2:1 paragraph 5.2.9).

Both the Ion Python and Neutralizing Hand Gun are NIST calibrated. They come equipped with universal IEC cord connectors.

MODEL	STYLE	VOLTAGE AC	IEC CORD
50620	Ion Python	120	Yes
50621	Ion Python	220	No
50622	Hand Gun	120	Yes
50623	Hand Gun	220	No

NOTE: These units are not recommended for continuous use.

IONIZER SELECTION

ANSI/ESD S20.20 paragraph 6.1.1.2. ESD Control Program Plan Guidance states: "The Plan should include a listing of the specific type of ESD protective materials and equipment used in the Program." When selecting an ionizer life cycle costs should be considered including: equipment cost; installation cost; and operation and maintenance cost.

Air Requirements

Always supply the Ion Python and Hand Gun with filtered, dry noncombustible gases, such as compressed shop air or nitrogen. (If nitrogen is used, the tip will need to be replaced and the unit recalibrated. This **MUST** be done by the factory.) If the air is not dry, damage to the equipment may result and the warranty will be voided. Dirty air can introduce moisture and oil, contaminating the units' emitter assembly along with the materials to be cleaned or neutralized. Filters must therefore be used at all times upstream of the air nozzle. A water trap-type pre-filter should be used in conjunction with an oil coalescing-type filter. Also drain all moisture traps regularly to prevent moisture in the line. Several drainings per day may be necessary, especially in areas of high humidity.

The Ion Python and Hand Gun may be operated over a range of 30 PSI to 100 PSI. The specific pressure needed will depend upon the application. Pressures exceeding 100 PSI are not recommended since these higher pressures are detrimental to effective ion production. An air pressure setting of 60 PSI is recommended. Use the needle valve located on the back of the controller to properly adjust the air flow.

Air Supply Connection

Turn off air at regulator (or compressor). Insert the brass male connector (1/4" tubing to 1/8" pipe thread) into an available port on the regulator. If all ports are being used, a "T" or "+" may be added to create more ports. Connect the 1/4" tubing to the male connector on the needle valve on back side of the unit, following the instructions given below.

To connect tubing or filter to quick connect fitting:

Cut end of plastic tubing square and clean. Push against the collar with thumbnail. While holding collar in, push tubing into the fitting until it bottoms out completely.

To release tubing or filter from quick connect fitting:

Push against the collar with thumbnail. While holding collar in, push tubing inward slightly, then pull tubing out.

IMPORTANT NOTE: User should exercise caution when using any compressed air device.

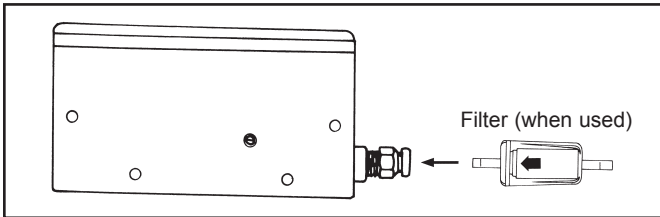

Figure 2. Connecting the filter.

Electrical Requirements

The Ion Python and Neutralizing Hand Gun must be connected to a properly grounded receptacle for the units to operate properly. It is recommended that the AC outlet be checked for proper wiring and grounding. (Use Desco 98130 AC Outlet Tester or equivalent)

Do not under any circumstances remove the ground pin from the plug of these units.

NOTE: Grounding of these units is necessary not only to ensure that they operate properly, but to eliminate the possibility of an electrical shock.

Operation

Turn on unit with switch on the front panel. The green light indicates that the air nozzle is ready for use. Point nozzle at object to be cleaned or neutralized.

When using the Ion Python, actuate foot pedal switch to initiate the flow of air and neutralizing ions. Best results are normally obtained when holding the nozzle within .5' to 1.5 feet of the item being neutralized.

For the Neutralizing Hand Gun, push button on the nozzle body to initiate the flow of air and neutralizing ions. Best results are normally obtained when holding the nozzle within 2 or 3 feet of the item being neutralized; hold the nozzle closer when required.

NOTE: Unit is not designed for continuous duty.

A needle valve is located on the back of the unit for fine adjustments to the air flow, or for shutting off the air to the nozzle. Airflow on the unit can be adjusted from a gentle blow to a strong blast, allowing for use in most applications. Do not obstruct the air jet with fingers or other objects. Do not force any object into the air jet hole; this action can easily damage the emitter pin and prevent the controller from producing the ionization necessary for neutralizing static charges.

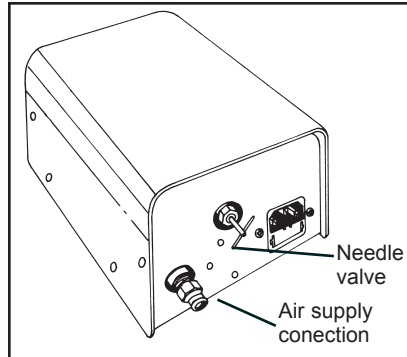

Figure 3. Airflow adjustment valve

Avoid sharply bending or crushing the black convoluted tubing under feet, rolling chairs or other furniture.

IMPORTANT NOTE: These air nozzles are not explosion proof. Do not use in environments where volatile materials are present.

EMIT solid-state electronic equipment is compact and rugged but should be treated as sensitive electronic equipment. With proper installation and a continued preventive maintenance program you will ensure the proper performance of the unit.

Theory of Operation

The Ion Python and Neutralizing Hand gun employ high voltage AC to create a balanced ion field. AC systems utilize emitters that are switched rapidly between positive and negative high voltage, usually at the power line frequency (50/60 Hz). The emitter is located at the end of the nozzle. This emitter produces large amounts of positive and negative ions, which mix with the air supply and create a highly effective neutralizing field. Any material within this field will be neutralized rapidly. The air nozzles also eliminate contamination by dislodging dust and debris which is attracted to a material's surface by static charges. Once static charges are neutralized, dust particles and other forms of contamination are freed and carried away by the air stream. EMIT ionizers meet the ANSI/ESD S20.20 minimum recommended technical requirement range of less than ± 50 volts voltage offset tested in accordance with ANSI ESD S3.1. Air Nozzle Ionizers typically can provide ± 20 volt offset balance.

Maintenance

"Periodic verification of ionizers is performed to provide continuing indication of required ionizer performance. The more critical the ionizer application, the more important it is to verify that the ionizers are working correctly. Periodic verification testing is most often performed under actual use conditions. In general, all ionizers should be checked, rather than a random sample." ESD SP3.3 Periodic Verification of Air Ionizers, A2.1

"Periodic verification procedures should be a part of the initial acceptance process to provide baseline data for comparison with future measurements. A schedule should be established for periodic verification testing." ESD SP3.3 Periodic Verification of Air Ionizers, section 7

"Ionizers should be tested for discharge time and balance after they have been installed in the use location. The time intervals for subsequent measurements will depend on the users requirements." ESD Handbook TR 20.20 paragraph 5.3.6.6.5

These units need very little maintenance. In order to maintain the optimum performance of your unit, the following maintenance procedures must be performed on a regular basis.

Make sure that the air supply is clean and free of contamination and moisture. Drain compressor tank and filters periodically.

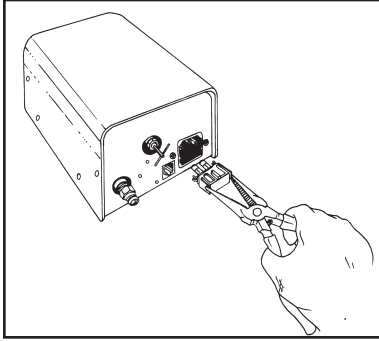

Figure 4. Replacing the fuse

The filters may require draining several times daily, depending on your compressed air system.

The fuse may be replaced by removing the power cord at the back of the unit and opening the fuse box at the IEC receptacle. The controller uses a 1 amp fast acting fuse. For safety, do not use other ratings.

Do not attempt to perform any repairs or adjustments on your EMIT equipment except for those covered in the operation manual. Self-made repairs could create a hazard and will void the warranty.

Replacing the Air Nozzle Assembly

The air nozzle and hose assembly is designed to be removed or replaced by the user in the event of damage or wear. To replace the assembly, simply unscrew the collar at the base of the hose and gently disconnect the connector from the receptacle.

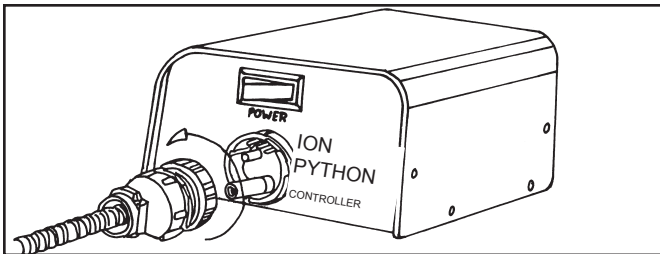

Figure 5. Replacing air nozzle assembly

To replace the nozzle assembly simply repeat the process in reverse.

NOTE: Make sure the fittings inside the connector are properly aligned with their receptacles before tightening the threaded collar.

Replacing the Air Filter of the Ion Python

Periodic replacement of the air filter is recommended for optimum performance of the ionizer. Examine the filter for any evidence of contamination. The filter will turn red if there is any oil contamination. If there has been moisture build-up, there will be a change in air volume or a brownish color to the filter. If either of these conditions exist, you should replace the filter by unsnapping connectors. Depress air line connectors allowing removal of filter. The filter replacement is sold as EMIT item #50626 (two filters to a package). Be sure to observe the flow direction on filter when installing a replacement.

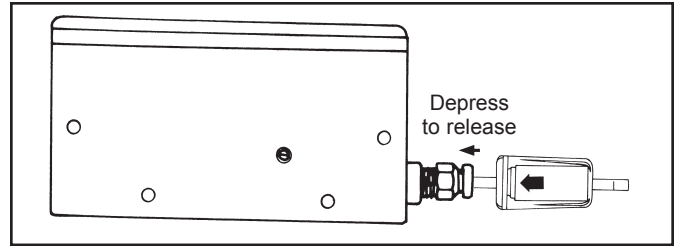

Figure 6. Air filter replacement

Installation of the Controller and Ion Python Attachment

The mounting slots on the bottom of the controller allow for easy mounting of the base. Install screws either on a wall or bench. Using the mounting slots, place controller on the screws for secure mounting of the unit. Mounting the controller underneath a bench or on a wall saves valuable bench space. After mounting the unit, a locking screw is provided on the back of the unit to prevent accidental removal.

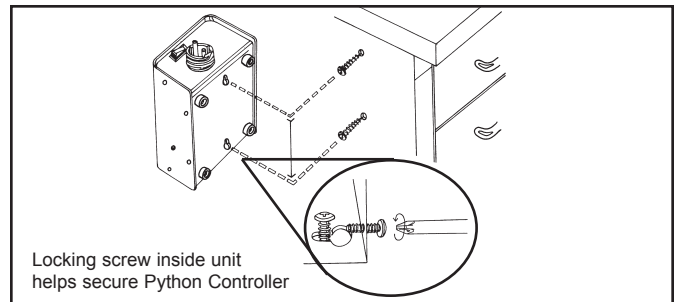

Figure 7. Installing controller to bench

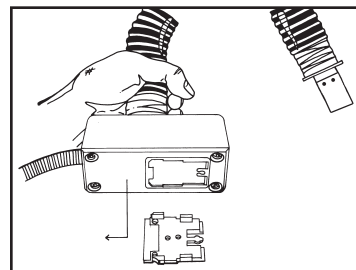

Figure 8. Installation of Ion Python to bench.

Once you have installed the base of the controller, you can now install the Ion Python Attachment to the bench. A bracket is included with the unit to facilitate easy mounting. Install bracket to the bench. Position the base of the Ion Python over the bracket and slide it on. Position the Ion Python so that the ion flow is focused on the equipment or area to be ionized.

Neutralization Efficiency (Discharge Time)

The comparative neutralization efficiency of ionizers is determined by a standard test published by the ESD Association Standard 3.1. The decay rates measured using this standard are shown in the chart below. This performance was measured with the air nozzle at a distance of 6" from the charged plate and utilizing an air pressure of 30 PSIG.

Rate per ANSI/ESD S3.1

Test Pressure	Rate
30 PSI	< 1 second under optimal conditions

Charge Time Constants

- Notes:
- 1) Times are from 1,000 volts to 100 volts and -1,000 to -100 volts.
 - 2) The air nozzle's air stream is perpendicular to the charged plate.

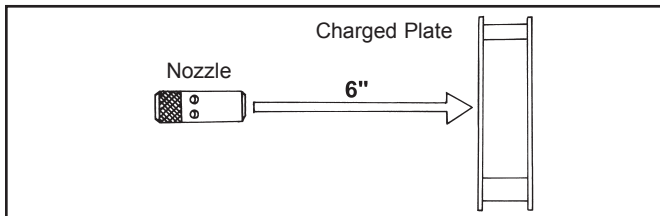

Figure 10. EOS/ESD S-3.1 decay time test set up

Testing and Calibration

Ionizers are tested and calibrated using a charged plate analyzer (EMIT Item #50555) or an Ionization Test Kit (EMIT Item #50598). A detailed test procedure is outlined in ESD Association's Standard ESD S3.1 and ESD SP3.3 which can be obtained directly from the ESD Association, 7902 Turin Road, Suite 4, Rome, NY 13440-2069, (315) 339-6937.

Adjustment

Offset voltage balance adjustment can be done by using the side adjustment potentiometer found on the side of the unit. Point ion stream to normal use setting and adjust ionization output for best and most efficient balance. Servicing should be performed only at the factory, or by a technician trained in high voltage circuits. See warranty section for repair information.

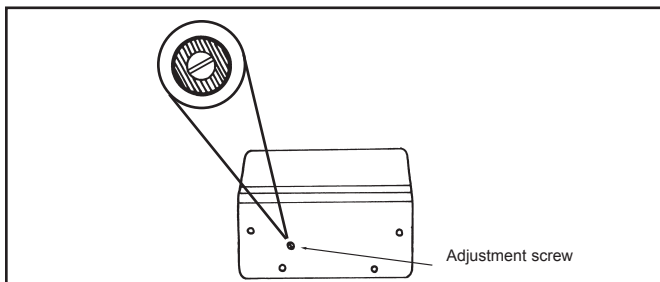

Figure 11. Balance Adjustment

Specifications

Input Voltage:	
50620 / 50622	120 VAC, 50/60 Hz
50621 / 50623	220 VAC, 50/60 Hz
Amperage standby:	<50 milliamps
Amperage in use:	<400 milliamps

Fuse:	2ea 1 amp, 5 x 20mm, fast acting
Power Usage:	2.5 watts on, 25 watts in use
Power Cord:	
50620 / 50622	Cord set with IEC connector
50621 / 50623	Not included
Python:	One-piece Delrin
Air Gun:	Two-piece molded ABS
Hose Length:	
50620 / 50621	5 feet
50622 / 50623	7 feet
Control Box:	5 1/8" H x 6 3/8" W x 7 1/8" L
Weight:	11 pounds
Air Usage:	3.5 CFM @ 30 PSI
Recommended PSI:	30 PSI to 100 PSI
Air fittings:	1/4" OD tubing with 1/8" NPT with adjustable needle valve.

Health

There are no known health risks associated with our devices. The emitters work at about 4-6 kV and can create ozone, but there have been no significant measurement of ozone from our emitter sets, as all our existing units test well below the OSHA limit of 0.05 ppm ozone. For additional safety information, see "Dispelling an Old Myth" written by William Metz of Hewlett-Packard published in Evaluation Engineering magazine, September 2001.

- Indoor use
- Altitude up to 2000m
- Temperature 5°C to 40°C
- Maximum relative humidity 80% for temperatures up to 31°C decreasing linearly to 50% relative humidity at 40°C
- Mains supply voltage fluctuations up to ±10% of the nominal voltage
- Transient overvoltages typically present on the mains supply
- Applicable rated pollution degree is 2
- Degree of ingress protection is IP10

Limited Warranty, Warranty Exclusions, Limit of Liability and RMA Request Instructions

See EMIT's Warranty -

<http://emit.descoindustries.com/Warranty.aspx>