



Chipsmall Limited consists of a professional team with an average of over 10 year of expertise in the distribution of electronic components. Based in Hongkong, we have already established firm and mutual-benefit business relationships with customers from,Europe,America and south Asia,supplying obsolete and hard-to-find components to meet their specific needs.

With the principle of “Quality Parts,Customers Priority,Honest Operation,and Considerate Service”,our business mainly focus on the distribution of electronic components. Line cards we deal with include Microchip,ALPS,ROHM,Xilinx,Pulse,ON,Everlight and Freescale. Main products comprise IC,Modules,Potentiometer,IC Socket,Relay,Connector.Our parts cover such applications as commercial,industrial, and automotives areas.

We are looking forward to setting up business relationship with you and hope to provide you with the best service and solution. Let us make a better world for our industry!



Contact us

Tel: +86-755-8981 8866 Fax: +86-755-8427 6832

Email & Skype: info@chipsmall.com Web: www.chipsmall.com

Address: A1208, Overseas Decoration Building, #122 Zhenhua RD., Futian, Shenzhen, China



PERM-O-PADS®

TO-5 and Integrated Circuit Mounts

Material Specifications:

White or Natural Nylon, per ASTM D4066 PA111, UL Rated 94V-2

Oxygen Rating Index: Over 28%

Standard Drawing Tolerances:

(unless otherwise indicated)

Fractions: $\pm 1/64$ (0.4) .XX = ± 0.01 (0.25)

.X = ± 0.10 (2.5) .XXX = ± 0.005 (0.13)

502-120

Price Code: A

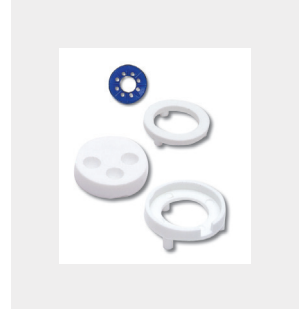
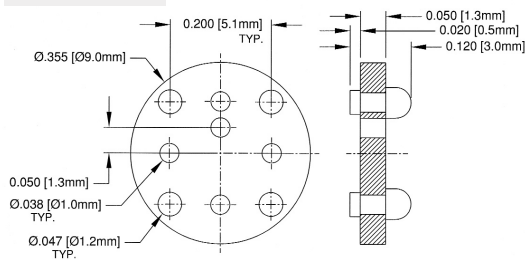

505-120

Price Code: A

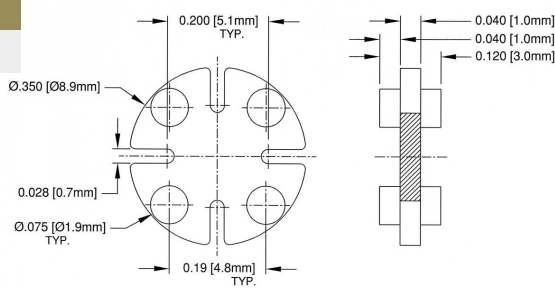

510-110

Price Code: A

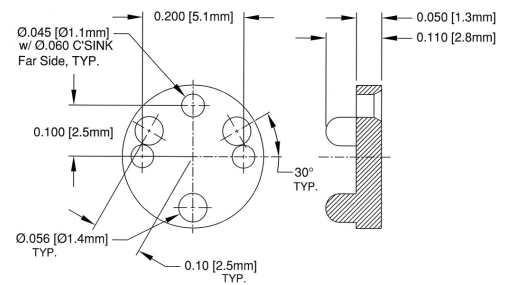

512-150

Price Code: A

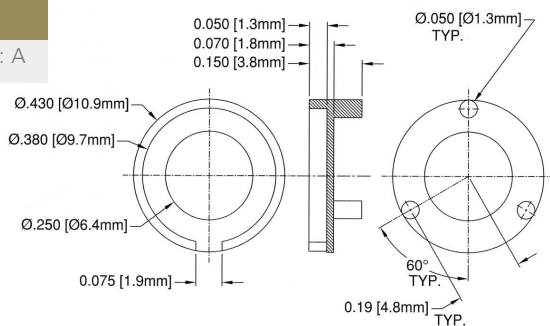

517-095

Price Code: A

A55485 / 02-025N
M38527 / 02-025N

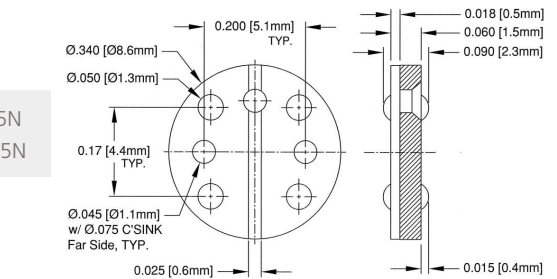

521-094

Price Code: A

A55485 / 01-041N
M38527 / 01-041N

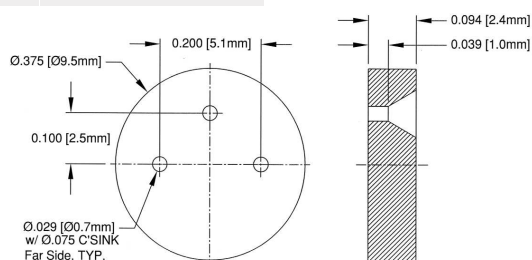

528-117

Price Code: A

A55485 / 02-022N
M38527 / 02-022N

