



Chipsmall Limited consists of a professional team with an average of over 10 year of expertise in the distribution of electronic components. Based in Hongkong, we have already established firm and mutual-benefit business relationships with customers from,Europe,America and south Asia,supplying obsolete and hard-to-find components to meet their specific needs.

With the principle of "Quality Parts,Customers Priority,Honest Operation,and Considerate Service",our business mainly focus on the distribution of electronic components. Line cards we deal with include Microchip,ALPS,ROHM,Xilinx,Pulse,ON,Everlight and Freescale. Main products comprise IC,Modules,Potentiometer,IC Socket,Relay,Connector.Our parts cover such applications as commercial,industrial, and automotives areas.

We are looking forward to setting up business relationship with you and hope to provide you with the best service and solution. Let us make a better world for our industry!



Contact us

Tel: +86-755-8981 8866 Fax: +86-755-8427 6832

Email & Skype: info@chipsmall.com Web: www.chipsmall.com

Address: A1208, Overseas Decoration Building, #122 Zhenhua RD., Futian, Shenzhen, China



IEC Appliance Inlet C20 with Filter, ECO design, front or rear side Mounting



Screw-on or rivet mounting from front or rear side
Screw-on mounting



Screw-on mounting from rear side, integrated thread
Screw-on mounting



Snap-in mounting from front side
Snap-in version

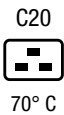

See below:
[Approvals and Compliances](#)

Description

- Panel mount :
Screw-on version from front or rear side, snap-in version from front side
- 2 Functions :
Appliance Inlet Protection class I , Line filter in standard and medical version
- Quick connect terminals

Unique Selling Proposition

- ECO design
- Metal flange for optimal shielding
- Compact design
- V-Lock cord retaining

Characteristics

- Optimal shielding due to completely closed filter case, unpotted
Suitable for assembly in metal plated plastic housings
- Version with class X1 and X2 (standard version) capacitors
- Universal line filter for standard applications
- Suitable for use in equipment according to IEC/UL 60950
Suitable for use in medical equipment according to IEC/UL 60601-1

Other versions on request

- Solder terminals
- Medical version M80
- Capacity CX 330 nF

References

Fits to type: [4790](#); [4795 0104](#); [0104U](#); [1651](#); [1652](#); [1654](#); [4790](#); [4795](#); [VAC19KS](#)
 Alternative: version without line filter [4793](#); [4798](#)

Weblinks

[pdf datasheet](#), [html-datasheet](#), [General Product Information](#), [Distributor-Stock-Check](#), [Accessories](#), [Detailed request for product](#), [Microsite](#)

Newly available variants corresponding to V-Lock mating cordset. The connector is equipped with a notch intended for use with the latching cordset. The cord latching system prevents against accidental removal of the cordset.

Technical Data

Ratings IEC	16A @ Ta 40 °C / 250VAC; 50Hz	appliance inlet/-outlet	C20 acc. to IEC 60320-1, UL 498, CSA C22.2 no. 42 (for cold conditions) pin-temperature 70 °C, 16A, Protection Class I
Ratings UL/CSA	20A @ Ta 40 °C / 250VAC; 60Hz	Line Filter	Standard and Medical Version, IEC 60939, UL 1283, CSA C22.2 no. 8 Technical Details
Leakage Current	standard < 0.5mA (250V / 60Hz) medical < 5 µA (250 V / 60 Hz)	MTBF	> 3'000'000h acc. to MIL-HB-217 F
Dielectric Strength	> 1.7kVDC between L-N > 2.7kVDC between L/N-PE Test voltage (2 sec)		
Impulse Withstand Voltage	> 2.5kV between L-N (CX2) > 4 kV between L-N (CX1) > 5 kV between L/N-PE (Cy2) voltage (1.2/50 µs)		
Allowable Operation Temperature	-25 °C to 85 °C		
Climatic Category	25/085/21 acc. to IEC 60068-1		
IP-Protection	from front side IP 40 acc. to IEC 60529		
Protection Class	Suitable for appliances with protection class I acc. to IEC 61140		
Terminal	Quick connect terminal 6.3 x 0.8 mm		
Panel Thickness S	Screw: max 8 mm Mounting screw torque max 0.5Nm Snap-in: 0.8 mm to 3 mm (all steps with one variant)		
Material: Housing	Themoplast / steel tin-plated, black / metallic, UL 94V-0		



Approvals and Compliances

Detailed information on product approvals, code requirements, usage instructions and detailed test conditions can be looked up in [Details about Approvals](#)

Approvals









The approval mark is used by the testing authorities to certify compliance with the safety requirements placed on electronic products.

Approval Reference Type: 5130

Approval Logo	Certificates	Certification Body	Description
	VDE Approvals	VDE	Certificate Number: 104884
	UL Approvals	UL	UL File Number: E72928



Product standards

Product standards that are referenced

Organization	Design	Standard	Description
	Designed according to	IEC 60320-1	Appliance couplers for household and similar general purposes
	Designed according to	IEC 60939	Passive filters for suppressing electromagnetic interference
	Designed according to	IEC 60127-6	Miniature fuses. Part 6. Fuse-holders for miniature fuse-links
	Designed according to	IEC 61058-1	Switches for appliances. Part 1. General requirements
	Designed according to	UL 498	Standard for Attachment Plugs and Receptacles
	Designed according to	UL 1283	Electromagnetic interference filters
	Designed according to	CSA C22.2 no. 42	General Use Receptacles, Attachment Plugs, and Similar Wiring Devices
	Designed according to	CSA C22.2 no. 8	Electromagnetic interference (EMI) filters







Application standards

Application standards where the product can be used

Organization	Design	Standard	Description
	Designed for applications acc.	IEC/UL 60950	IEC 60950-1 includes the basic requirements for the safety of information technology equipment.
	Designed for applications acc.	IEC 60601-1	Medical electrical equipment - Part 1: General requirements for basic safety and essential performance

Compliances

The product complies with following Guide Lines

Identification	Details	Initiator	Description
	CE declaration of conformity	SCHURTER AG	The CE marking declares that the product complies with the applicable requirements laid down in the harmonisation of Community legislation on its affixing in accordance with EU Regulation 765/2008.
	RoHS	SCHURTER AG	EU Directive RoHS 2011/65/EU
	China RoHS	SCHURTER AG	The law SJ / T 11363-2006 (China RoHS) has been in force since 1 March 2007. It is similar to the EU directive RoHS.
	REACH	SCHURTER AG	On 1 June 2007, Regulation (EC) No 1907/2006 on the Registration, Evaluation, Authorization and Restriction of Chemicals 1 (abbreviated as "REACH") entered into force.
	MicrositeV-Lock	SCHURTER AG	V-Lock system are based on a matching plug-dose combination. The connector is equipped with a notch intended for use with the latching cordset. The cord latching system prevents against accidental removal of the cordset.
	Medical Equipment	SCHURTER AG	Suitable for use in medical equipment according to IEC/UL 60601-1

Dimensions [mm]

Front or rear side mounting for screws with nuts or blind rivets

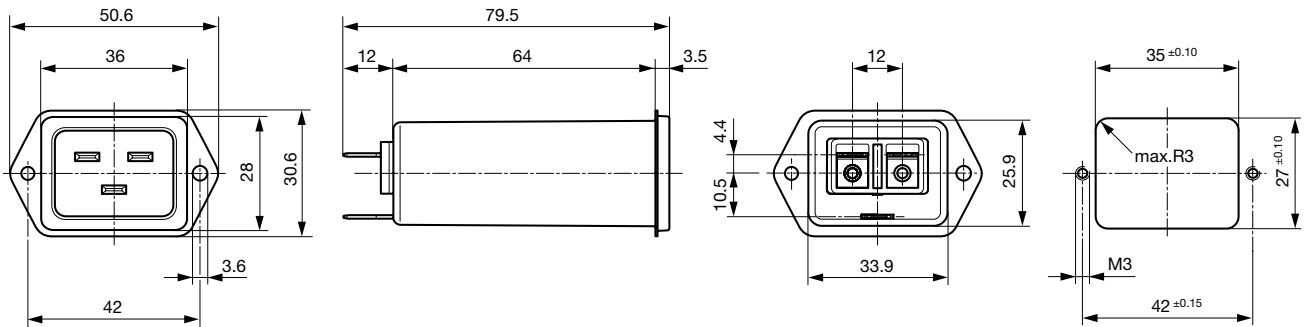

Rear side mounting with pre-formed, threaded holes for M3 screws

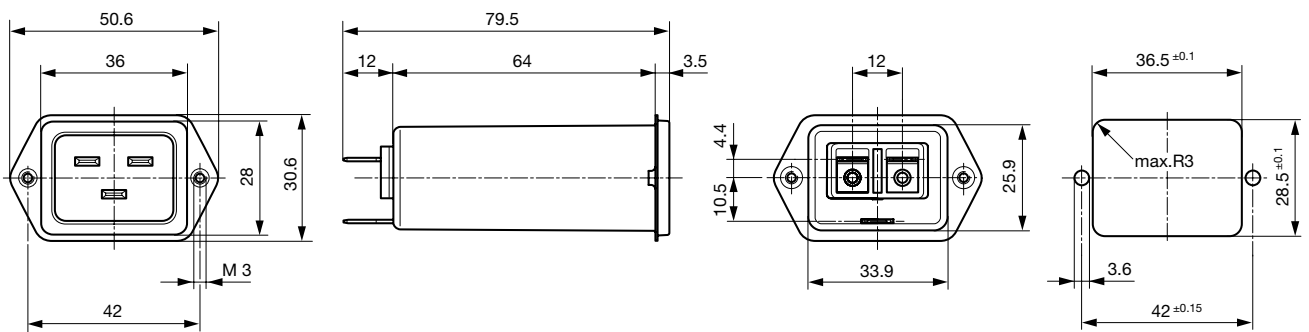

Snap-in mounting from front side

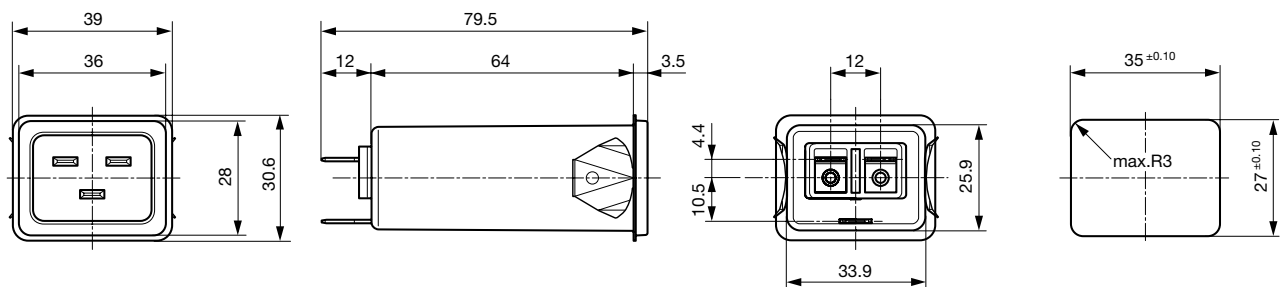

Technical Data of Filter-Components

Rated Current [A]	Filter-Type	Inductances L [mH]	Capacitance CX [nF]	Capacitance CY [nF]	R [MΩ]
16	Standard Version	2 x 0.6	100	2.2	1
16	Standard Version	2 x 0.6	330	2.2	1
20	Standard Version	2 x 0.3	100	2.2	1
20	Standard Version	2 x 0.3	330	2.2	1
16	Medical Version (M5)	2 x 0.6	100	-	1
20	Medical Version (M5)	2 x 0.3	100	-	1

Diagrams

Standard or medical version (M80)

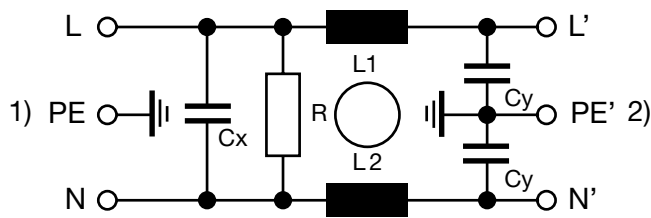

1) Line
2) Load

Medical version (M5)

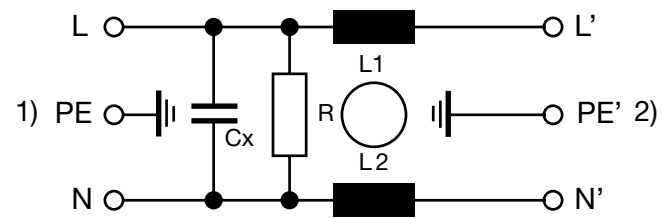

1) Line
2) Load

Attenuation Loss

--- 50Ω differential mode ____ 50Ω common mode

Standard version

16 A

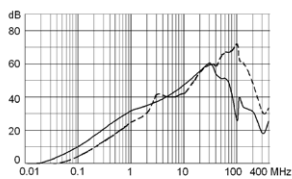

20 A

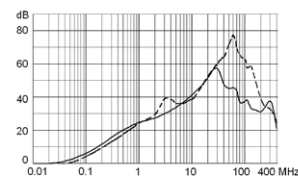

16 A Cx 330 nF

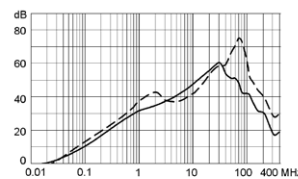

20 A Cx 330 nF

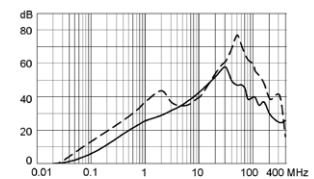

Medical version (M5)

16 A

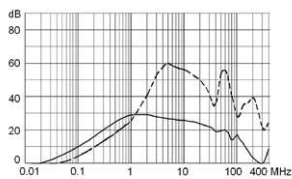

20 A

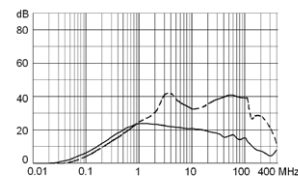

All Variants

Rated Current IEC	Rated Current UL	Filter-Type	Panel mounting	Mounting side	Terminal	Capacitor	V-Lock	Order Number
16	16	Standard Version	Snap-in	Front Side	Quick connect terminals 6.3 x 0.8 mm	X2 100nF		5130.2000
16	20	Standard Version	Snap-in	Front Side	Quick connect terminals 6.3 x 0.8 mm	X2 100nF		5130.2001
16	16	Standard Version	Snap-in	Front Side	Quick connect terminals 6.3 x 0.8 mm	X1 100nF		5130.2100
16	20	Standard Version	Snap-in	Front Side	Quick connect terminals 6.3 x 0.8 mm	X1 100nF		5130.2101
16	16	Standard Version	Screw-on/Rivet	Front Side	Quick connect terminals 6.3 x 0.8 mm	X2 330nF		5130.0600

Rated Current IEC	Rated Current UL	Filter-Type	Panel mounting	Mounting side	Terminal	Capacitor	V-Lock	Order Number
16	20	Standard Version	Screw-on/Rivet	Front Side	Quick connect terminals 6.3 x 0.8 mm	X2 330nF		5130.0601
16	16	Standard Version	Screw-on/Rivet	Front Side	Quick connect terminals 6.3 x 0.8 mm	X2 100nF		5130.0000
16	16	Standard Version	Screw-on/Rivet	Front Side	Quick connect terminals 6.3 x 0.8 mm	X2 100nF	●	5130.0000.21
16	20	Standard Version	Screw-on/Rivet	Front Side	Quick connect terminals 6.3 x 0.8 mm	X2 100nF		5130.0001
16	16	Standard Version	Screw-on/Rivet	Front Side	Quick connect terminals 6.3 x 0.8 mm	X1 100nF		5130.0100
16	20	Standard Version	Screw-on/Rivet	Front Side	Quick connect terminals 6.3 x 0.8 mm	X1 100nF		5130.0101
16	16	Standard Version	Screw	Rear Side	Quick connect terminals 6.3 x 0.8 mm	X2 100nF		5130.1000
16	20	Standard Version	Screw	Rear Side	Quick connect terminals 6.3 x 0.8 mm	X2 100nF		5130.1001
16	16	Standard Version	Screw	Rear Side	Quick connect terminals 6.3 x 0.8 mm	X1 100nF		5130.1100
16	20	Standard Version	Screw	Rear Side	Quick connect terminals 6.3 x 0.8 mm	X1 100nF		5130.1101
16	20	Medical Version (M5)	Snap-in	Front Side	Quick connect terminals	X1 100nF		5130.2301
16	16	Medical Version (M5)	Snap-in	Front Side	Quick connect terminals 6.3 x 0.8 mm	X2 100nF		5130.2200
16	20	Medical Version (M5)	Snap-in	Front Side	Quick connect terminals 6.3 x 0.8 mm	X2 100nF		5130.2201
16	16	Medical Version (M5)	Snap-in	Front Side	Quick connect terminals 6.3 x 0.8 mm	X1 100nF		5130.2300
16	16	Medical Version (M5)	Screw-on/Rivet	Front Side	Quick connect terminals 6.3 x 0.8 mm	X2 100nF		5130.0200
16	20	Medical Version (M5)	Screw-on/Rivet	Front Side	Quick connect terminals 6.3 x 0.8 mm	X2 100nF		5130.0201
16	16	Medical Version (M5)	Screw-on/Rivet	Front Side	Quick connect terminals 6.3 x 0.8 mm	X1 100nF		5130.0300
16	16	Medical Version (M5)	Screw-on/Rivet	Front Side	Quick connect terminals 6.3 x 0.8 mm	X1 100nF	●	5130.0300.21
16	20	Medical Version (M5)	Screw-on/Rivet	Front Side	Quick connect terminals 6.3 x 0.8 mm	X1 100nF		5130.0301
16	16	Medical Version (M5)	Screw	Rear Side	Quick connect terminals 6.3 x 0.8 mm	X2 100nF		5130.1200
16	20	Medical Version (M5)	Screw	Rear Side	Quick connect terminals 6.3 x 0.8 mm	X2 100nF		5130.1201
16	16	Medical Version (M5)	Screw	Rear Side	Quick connect terminals 6.3 x 0.8 mm	X1 100nF		5130.1300
16	20	Medical Version (M5)	Screw	Rear Side	Quick connect terminals 6.3 x 0.8 mm	X1 100nF		5130.1301

Most Popular.

Availability for all products can be searched real-time: <https://www.schurter.com/en/Stock-Check/Stock-Check-SCHURTER>

Type for screw on mounting from rear side has pre-threaded holes for M3 screws

Packaging unit 20 Pcs

Accessories

Description



Wire Harness
 Wire harness for SCHURTER products



Assorted Covers
 Rear Cover

0859.0047



Cord retaining kits
 Cord retaining strain relief

Flat head, L

4700.0011

Mating Inlets/Plugs

Category / Description



Connector Overview complete

IEC Connector C19, Rewireable, Straight

4795

IEC Connector C19, Rewireable, Angled

4790

Connector further types to 5130

Mating Outlets/Connectors



Connector Overview complete

IEC Connector C19, Rewireable, Straight

4795

IEC Connector C19, Rewireable, Angled

4790

Connector further types to 5130

Mating Outlets/Connectors shuttered



[Power Cord Overview complete](#)

[Overview Power Cord with IEC Appliance Connector C19, V-Lock, straight](#)

[VAC19KS](#)

[Power Cord further types to 5130](#)