



Chipsmall Limited consists of a professional team with an average of over 10 year of expertise in the distribution of electronic components. Based in Hongkong, we have already established firm and mutual-benefit business relationships with customers from,Europe,America and south Asia,supplying obsolete and hard-to-find components to meet their specific needs.

With the principle of “Quality Parts,Customers Priority,Honest Operation,and Considerate Service”,our business mainly focus on the distribution of electronic components. Line cards we deal with include Microchip,ALPS,ROHM,Xilinx,Pulse,ON,Everlight and Freescale. Main products comprise IC,Modules,Potentiometer,IC Socket,Relay,Connector.Our parts cover such applications as commercial,industrial, and automotives areas.

We are looking forward to setting up business relationship with you and hope to provide you with the best service and solution. Let us make a better world for our industry!



Contact us

Tel: +86-755-8981 8866 Fax: +86-755-8427 6832

Email & Skype: info@chipsmall.com Web: www.chipsmall.com

Address: A1208, Overseas Decoration Building, #122 Zhenhua RD., Futian, Shenzhen, China



PERM-O-PADS®

TO-5 Mounts

Material Specifications:

White or Natural Nylon, per ASTM D4066 PA111, UL Rated 94V-2

Oxygen Rating Index: Over 28%

Standard Drawing Tolerances:

(unless otherwise indicated)

Fractions: $\pm 1/64$ (0.4) .XX = ± 0.01 (0.25)

.X = ± 0.10 (2.5) .XXX = ± 0.005 (0.13)

513-075

Price Code: A

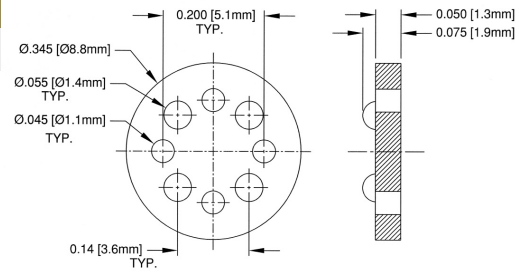

515-020

Price Code: A

A55485 / 02-018N

M38527 / 02-018N

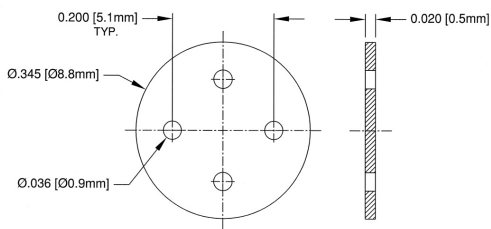

516-038

Price Code: A

A55485 / 02-013N

M38527 / 02-013N

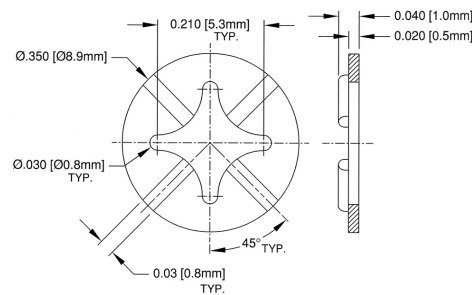

518-038

Price Code: A

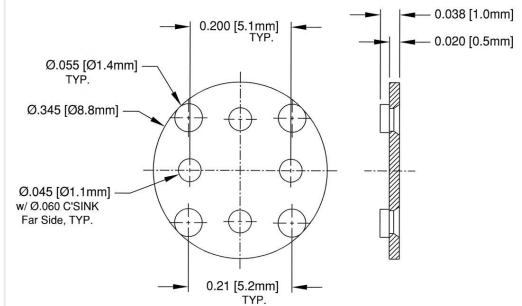

520-021

Price Code: A

A55485 / 02-019N

M38527 / 02-019N

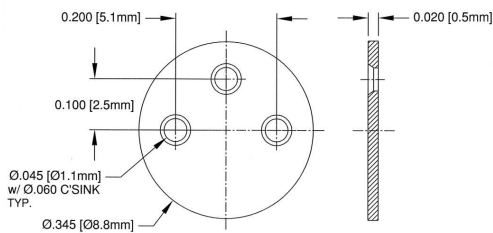

525-038

Price Code: A

A55485 / 02-014N

M38527 / 02-014N

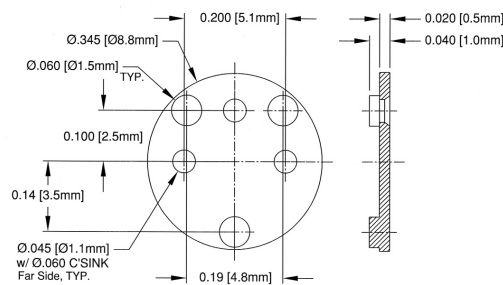

526-090

Price Code: A

A55485 / 02-038N

M38527 / 02-038N

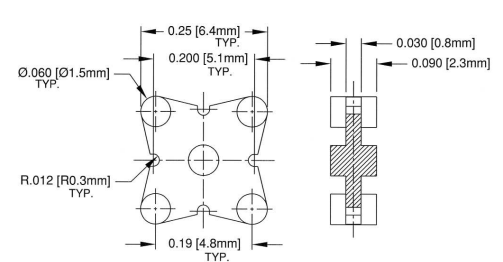

532-050

Price Code: A

