



Chipsmall Limited consists of a professional team with an average of over 10 year of expertise in the distribution of electronic components. Based in Hongkong, we have already established firm and mutual-benefit business relationships with customers from,Europe,America and south Asia,supplying obsolete and hard-to-find components to meet their specific needs.

With the principle of “Quality Parts,Customers Priority,Honest Operation,and Considerate Service”,our business mainly focus on the distribution of electronic components. Line cards we deal with include Microchip,ALPS,ROHM,Xilinx,Pulse,ON,Everlight and Freescale. Main products comprise IC,Modules,Potentiometer,IC Socket,Relay,Connector.Our parts cover such applications as commercial,industrial, and automotives areas.

We are looking forward to setting up business relationship with you and hope to provide you with the best service and solution. Let us make a better world for our industry!



## Contact us

Tel: +86-755-8981 8866 Fax: +86-755-8427 6832

Email & Skype: info@chipsmall.com Web: www.chipsmall.com

Address: A1208, Overseas Decoration Building, #122 Zhenhua RD., Futian, Shenzhen, China



THIS DRAWING IS UNPUBLISHED. RELEASED FOR PUBLICATION  
 © COPYRIGHT BY ALL RIGHTS RESERVED.

LOC		DIST		REVISIONS				
P	LTR	DESCRIPTION			DATE	DWN	APVD	
	A4	REVISED PER ECO-11-005139			19MAR11	RK	HMR	

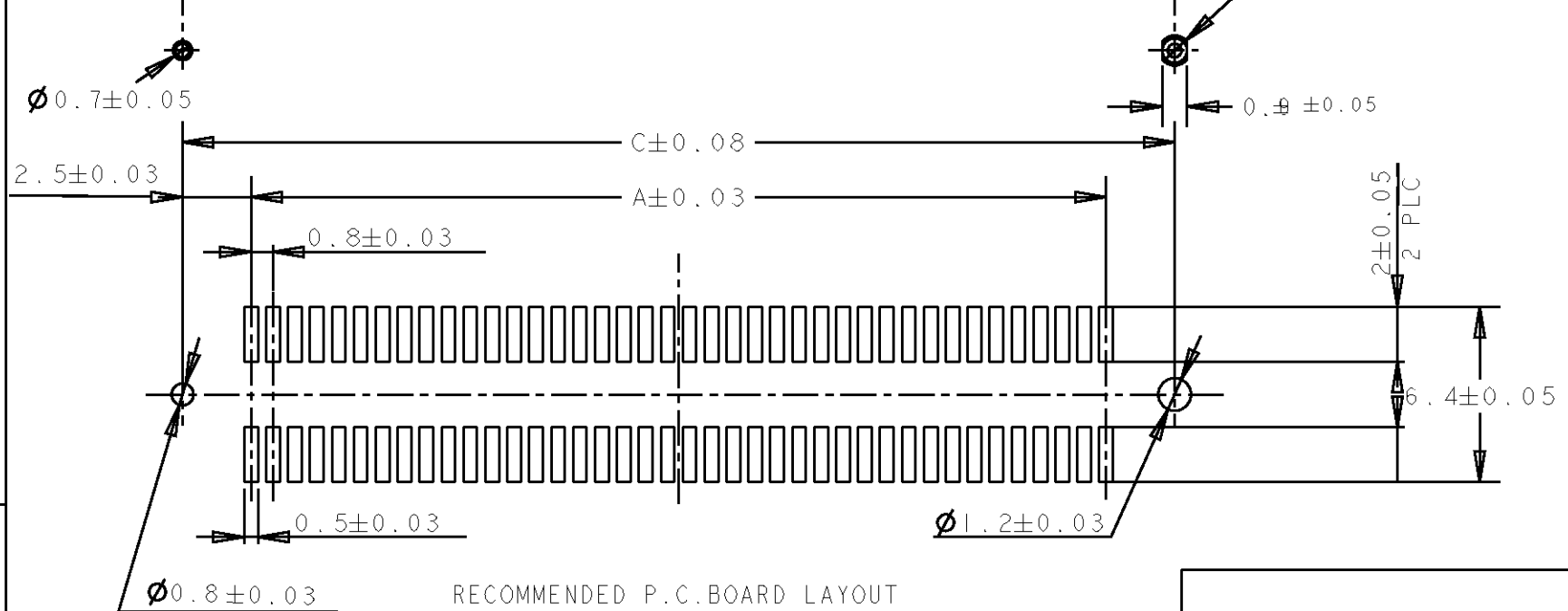
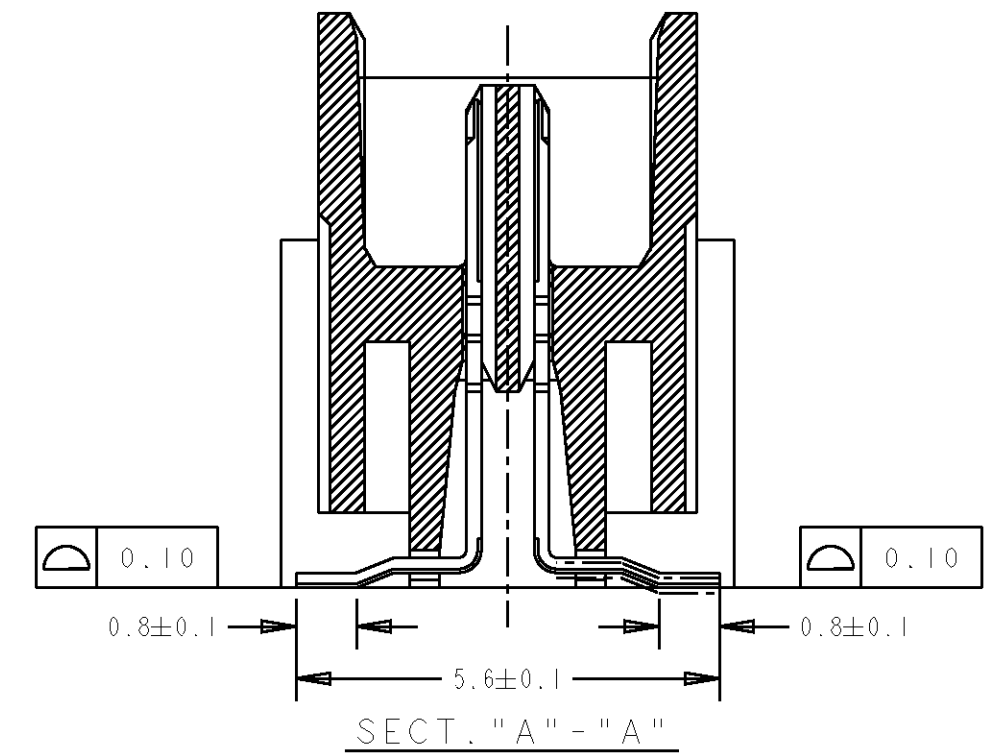
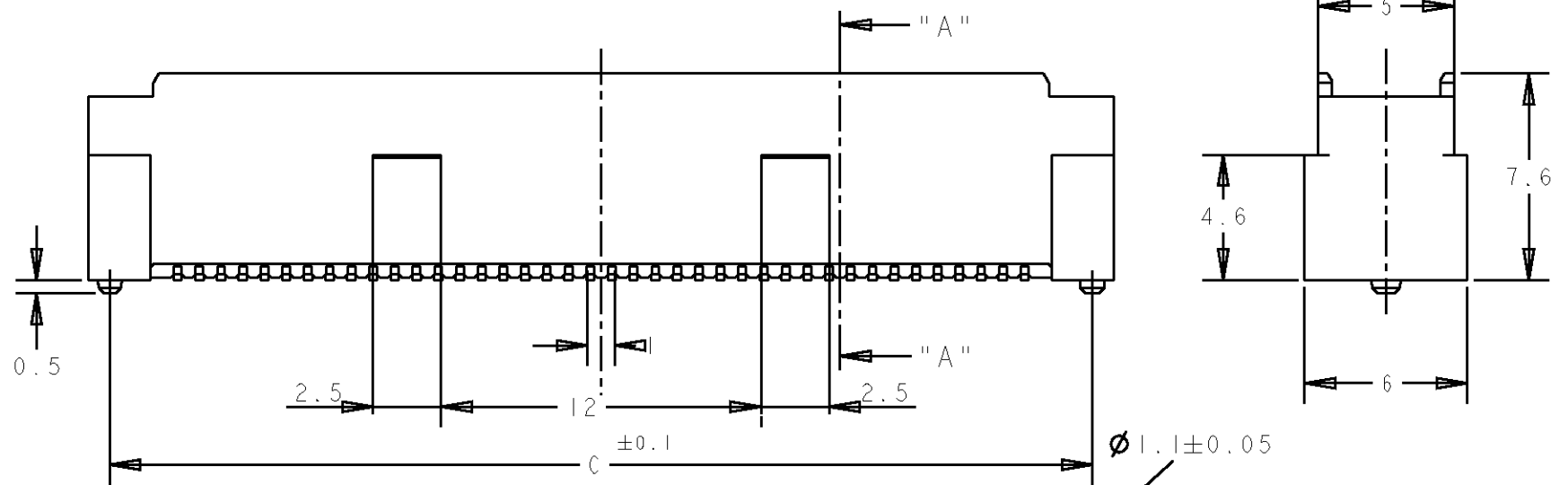
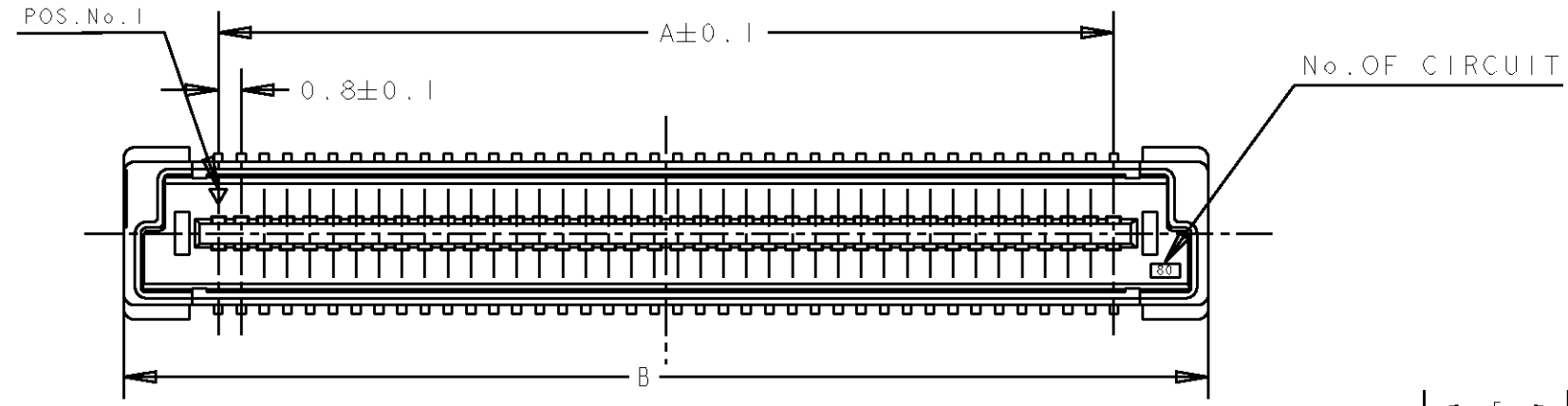

- NOTES:
- 1. MATERIAL:  
HOUSING: L.C.P.(HIGH TEMP THERMO PLASTIC)  
UL 94V-0, NATURAL.  
CONTACT: BRASS.
  - 2. FINISH:  
CONTACT AREA: 0.0002 MIN GOLD  
SOLDERING AREA: 0.0020 MIN MATTE-TIN  
UNDERPLATE: 0.0013 MIN NICKEL ALL OVER
  - 3. POSITION SERIES: SEE TABLE.
  - 4. CONN STACK HEIGHT COMBINE OF PLUG "Y"H VS REC "X"H.  
STACK HEIGHT = Y + X - 5
  - 5. OBSOLETE PARTS: OBSOLETE CIS STREAMLINING PER D.RENAUD/D.SINISI

DIMENSIONS: mm		TOLERANCES UNLESS OTHERWISE SPECIFIED:		DWN 28 JUL 04 FLORENCE TAN		<b>STE</b> TE Connectivity	
		0 PLC ±-	1 PLC ±0.30	CHK ERIC TNG			
		2 PLC ±0.25	3 PLC ±0.20	APVD SEIFONG		NAME PLUG ASSEMBLY 8H TYPE (0.5 BOSS LENGTH) FOR FH 0.8MM PITCH B-T-B CONNECTOR	
		4 PLC ±-	ANGLES ±3°	PRODUCT SPEC 108-5390		SIZE A3	
MATERIAL		FINISH		APPLICATION SPEC 114-5254		CAGE CODE 00779	
				WEIGHT -		DRAWING NO C-5179031	
CUSTOMER DRAWING				SCALE 4:1		SHEET 1 OF 2	
						REV A4	

THIS DRAWING IS UNPUBLISHED. RELEASED FOR PUBLICATION .19 .  
 © COPYRIGHT BY ALL RIGHTS RESERVED.

LOC DY	DIST -	REVISIONS			
P	LTR	DESCRIPTION	DATE	DWN	APVD
		SEE SHEET 1			

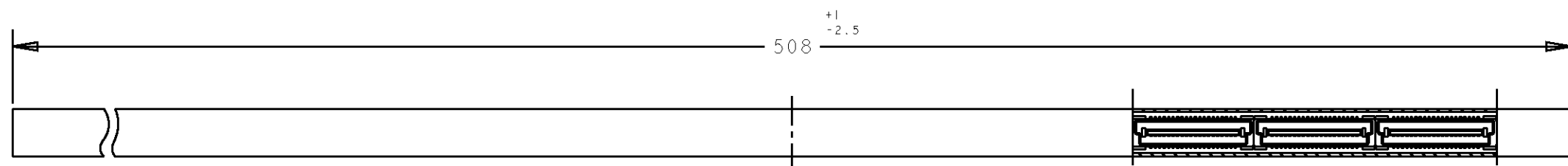

SECT A-A

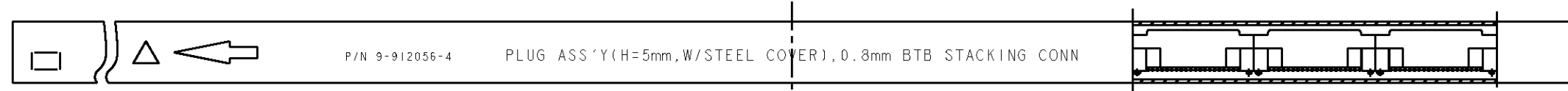

SECT B-B

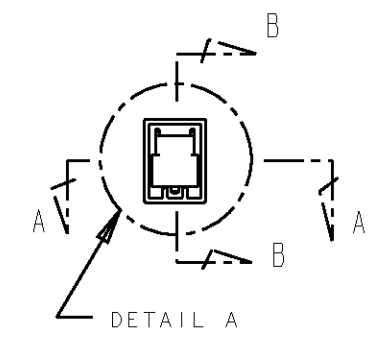

P/N 9-912056-4 PLUG ASS'Y (H=5mm, W/STEEL COVER), 0.8mm BTB STACKING CONN

REFERENCE PICTURE OF TUBE PACK

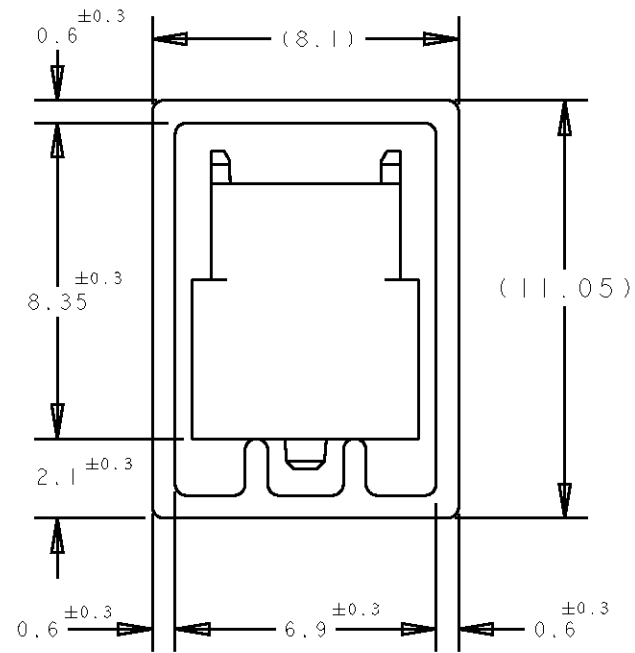

DETAIL "B"  
(SCALE 5-1)

<b>5</b> OBSOLETE	11	40.2	41.8	35.2	90	1-	-2
	14	32.2	33.8	27.2	70	1-	-1
	5	84.2	85.8	79.2	200	1-	-0
	6	76.2	77.8	71.2	180		-9
	6	68.2	69.8	63.2	160		-8
	7	60.2	61.8	55.2	140		-6
	9	52.2	53.8	47.2	120		-5
	10	44.2	45.8	39.2	100		-4
	12	36.2	37.8	31.2	80		-3
	16	28.2	29.8	23.2	60		-2
22	20.2	21.8	15.2	40			5179031-1
QTY/ TUBE	C	B	A	POS.	CONN P/N		

DIMS: mm		TOLERANCES UNLESS OTHERWISE SPECIFIED:		DWN FLORENCE 28JUL04		<b>STE</b> TE Connectivity	
		0 PLC ±- 1 PLC ±0.30 2 PLC ±0.25 3 PLC ±0.20 4 PLC ±- ANGLES ±3°		CHK ERIC TNG			
MATERIAL		FINISH		APVD SEIFONG		DRAWING NO	
				PRODUCT SPEC 108-5390		SIZE A3	
				APPLICATION SPEC 114-5254		CAGE CODE 00779	
				WEIGHT -		DRAWING NO C-5179031	
CUSTOMER DRAWING				SCALE 4:1		SHEET 2 OF 2	
						REV A4	