



Chipsmall Limited consists of a professional team with an average of over 10 year of expertise in the distribution of electronic components. Based in Hongkong, we have already established firm and mutual-benefit business relationships with customers from,Europe,America and south Asia,supplying obsolete and hard-to-find components to meet their specific needs.

With the principle of "Quality Parts,Customers Priority,Honest Operation,and Considerate Service",our business mainly focus on the distribution of electronic components. Line cards we deal with include Microchip,ALPS,ROHM,Xilinx,Pulse,ON,Everlight and Freescale. Main products comprise IC,Modules,Potentiometer,IC Socket,Relay,Connector.Our parts cover such applications as commercial,industrial, and automotives areas.

We are looking forward to setting up business relationship with you and hope to provide you with the best service and solution. Let us make a better world for our industry!



Contact us

Tel: +86-755-8981 8866 Fax: +86-755-8427 6832

Email & Skype: info@chipsmall.com Web: www.chipsmall.com

Address: A1208, Overseas Decoration Building, #122 Zhenhua RD., Futian, Shenzhen, China



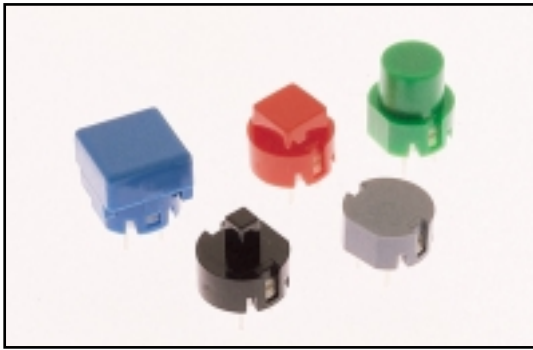

SPECIFICATIONS

Ratings: 10mA @ 35 VDC
 Electrical Life: 500,000 cycles typical
 Contact Resistance: 10mΩ max., typical @ 2-4 VDC, 100mA
 Insulation Resistance: 1,00MΩ min.
 Dielectric Strength: >1,000 V rms at sea level
 Operating Force: 130 ± 50 gf

MATERIALS

Housing: Polycarbonate (PC)
 Base: Valox
 Contacts: Silver-plated copper alloy
 Terminals: Silver-plated copper alloy

HOW TO ORDER

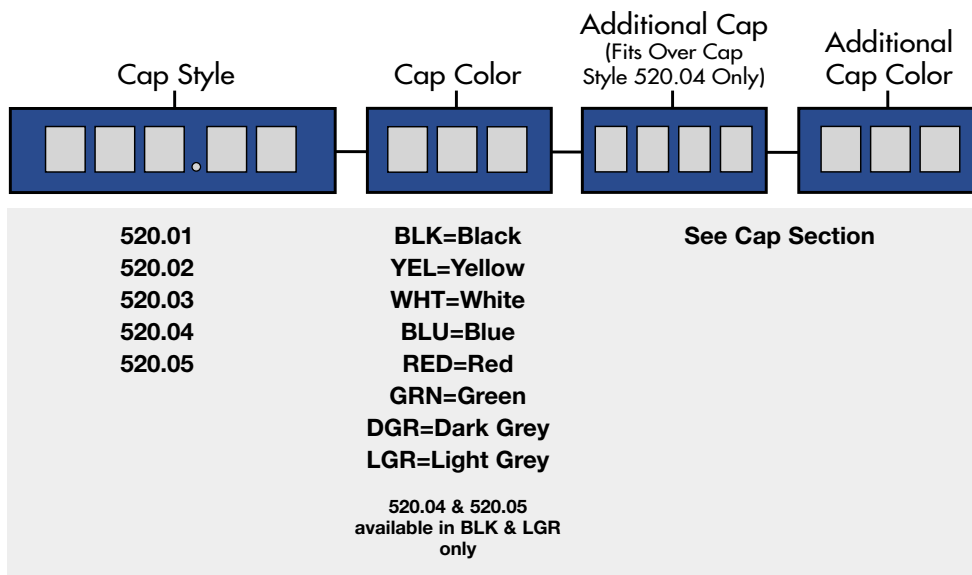

EXAMPLE

520.04 → BLK → TAA → RED

SPECIFICATIONS SUBJECT TO CHANGE WITHOUT NOTICE.

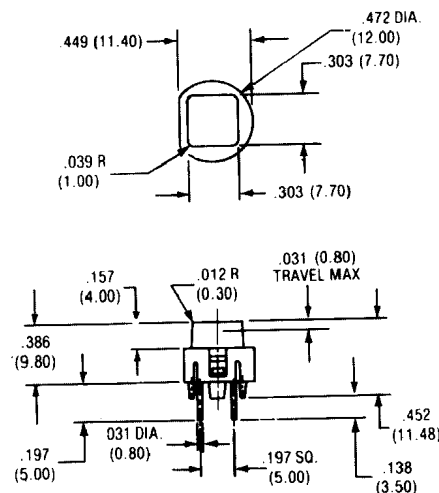

P.C. MOUNTING

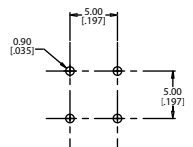

Schematic

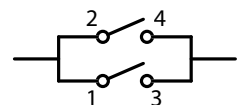

PUSHBUTTON SWITCHES



520.02

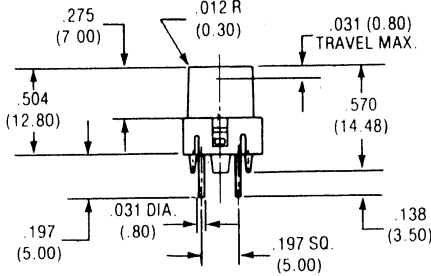
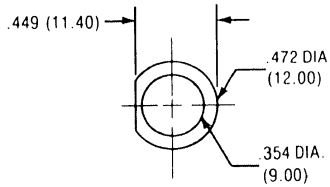

P.C. MOUNTING

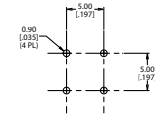

Schematic

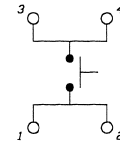

520.03

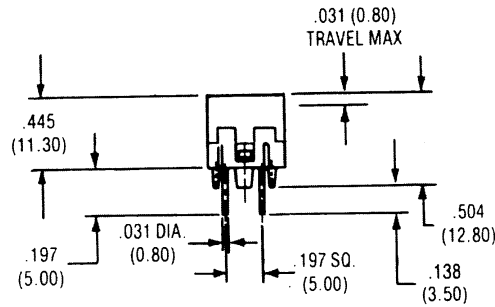
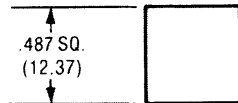

P.C. MOUNTING

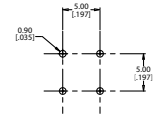

Schematic

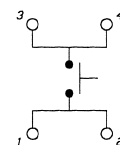

520.04

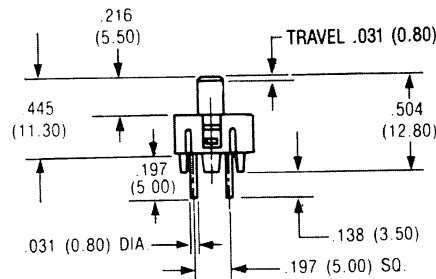
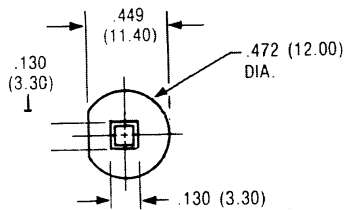

P.C. MOUNTING

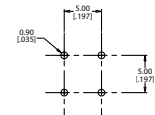

Schematic

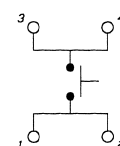

520.05

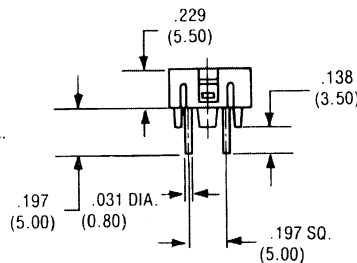
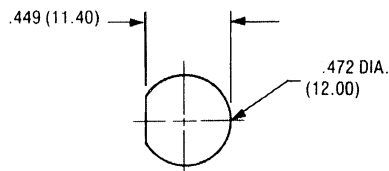

P.C. MOUNTING

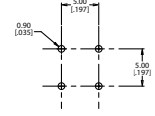

Schematic

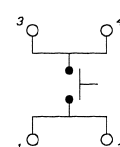

520.04 and 520.05 are available in black and light grey only.

SPECIFICATIONS SUBJECT TO CHANGE WITHOUT NOTICE.