



Chipsmall Limited consists of a professional team with an average of over 10 year of expertise in the distribution of electronic components. Based in Hongkong, we have already established firm and mutual-benefit business relationships with customers from,Europe,America and south Asia,supplying obsolete and hard-to-find components to meet their specific needs.

With the principle of “Quality Parts,Customers Priority,Honest Operation,and Considerate Service”,our business mainly focus on the distribution of electronic components. Line cards we deal with include Microchip,ALPS,ROHM,Xilinx,Pulse,ON,Everlight and Freescale. Main products comprise IC,Modules,Potentiometer,IC Socket,Relay,Connector.Our parts cover such applications as commercial,industrial, and automotives areas.

We are looking forward to setting up business relationship with you and hope to provide you with the best service and solution. Let us make a better world for our industry!



## Contact us

Tel: +86-755-8981 8866 Fax: +86-755-8427 6832

Email & Skype: info@chipsmall.com Web: www.chipsmall.com

Address: A1208, Overseas Decoration Building, #122 Zhenhua RD., Futian, Shenzhen, China



LOC	DIST	REVISIONS			
		REV	DESCRIPTION	DATE	BY
AD	47	C	REVISED PER EC 0512-0278-05	21JUL05	JDP RW
		C1	REVISED PER ECO-10-000444	16JAN10	KK AEG

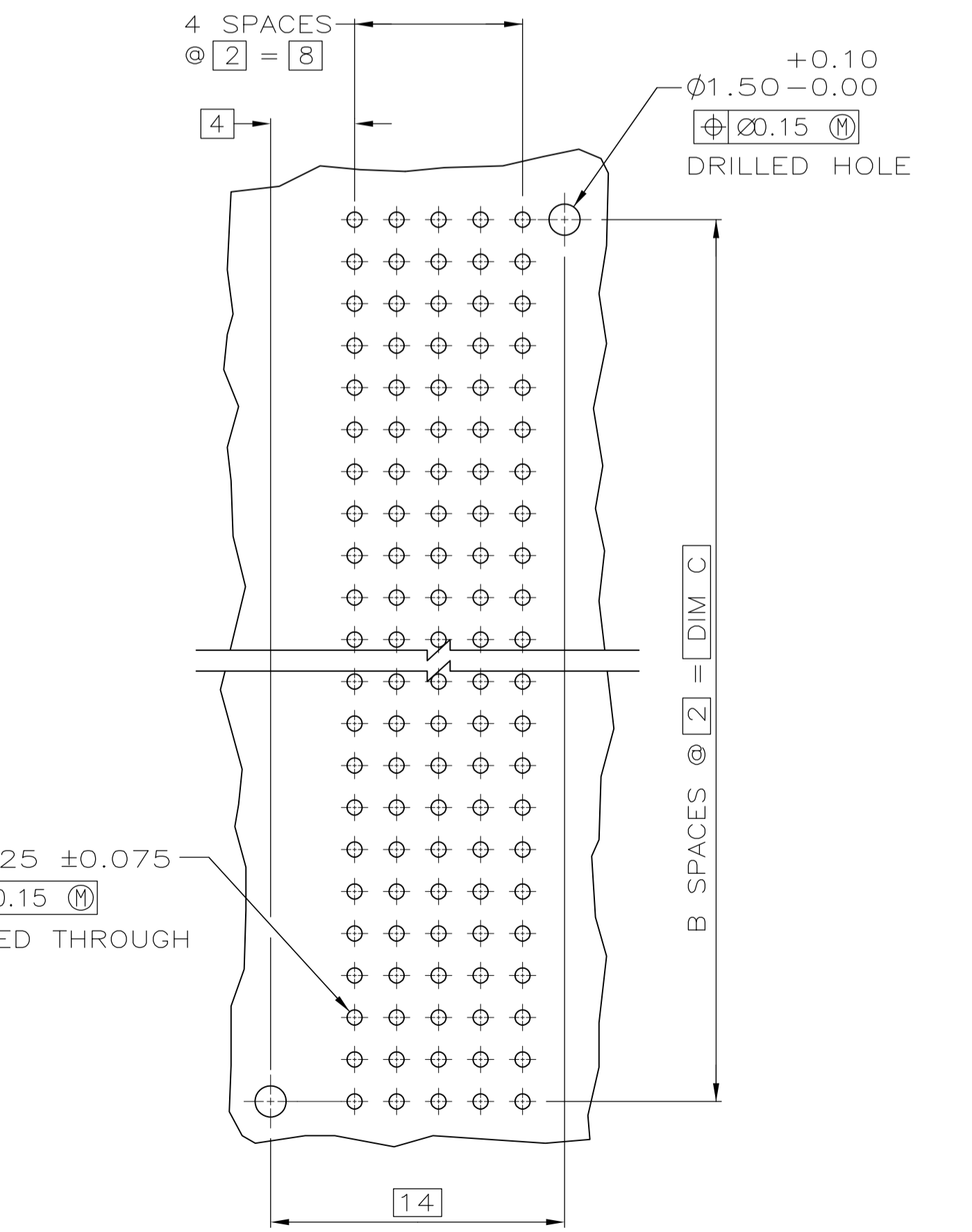
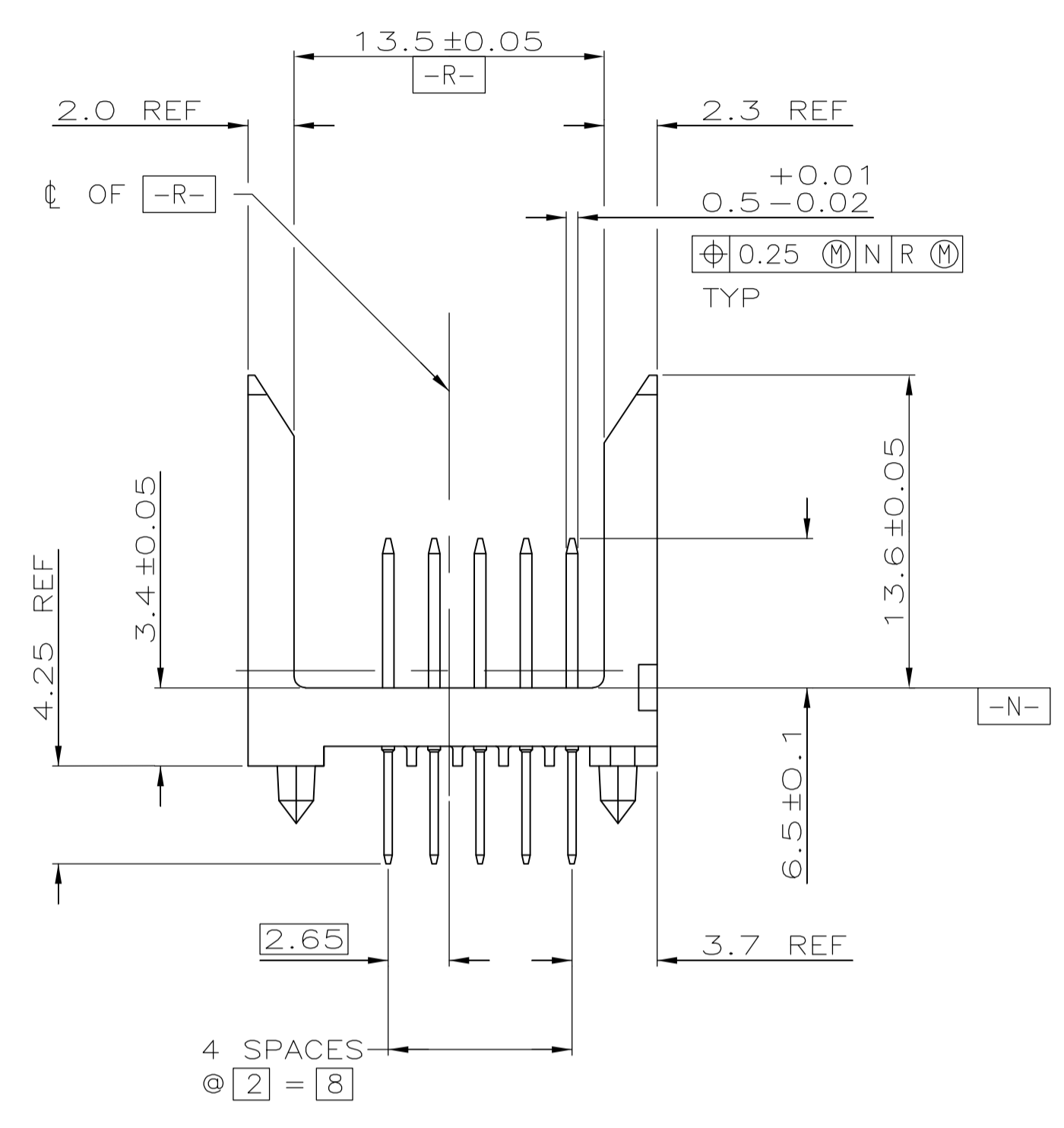
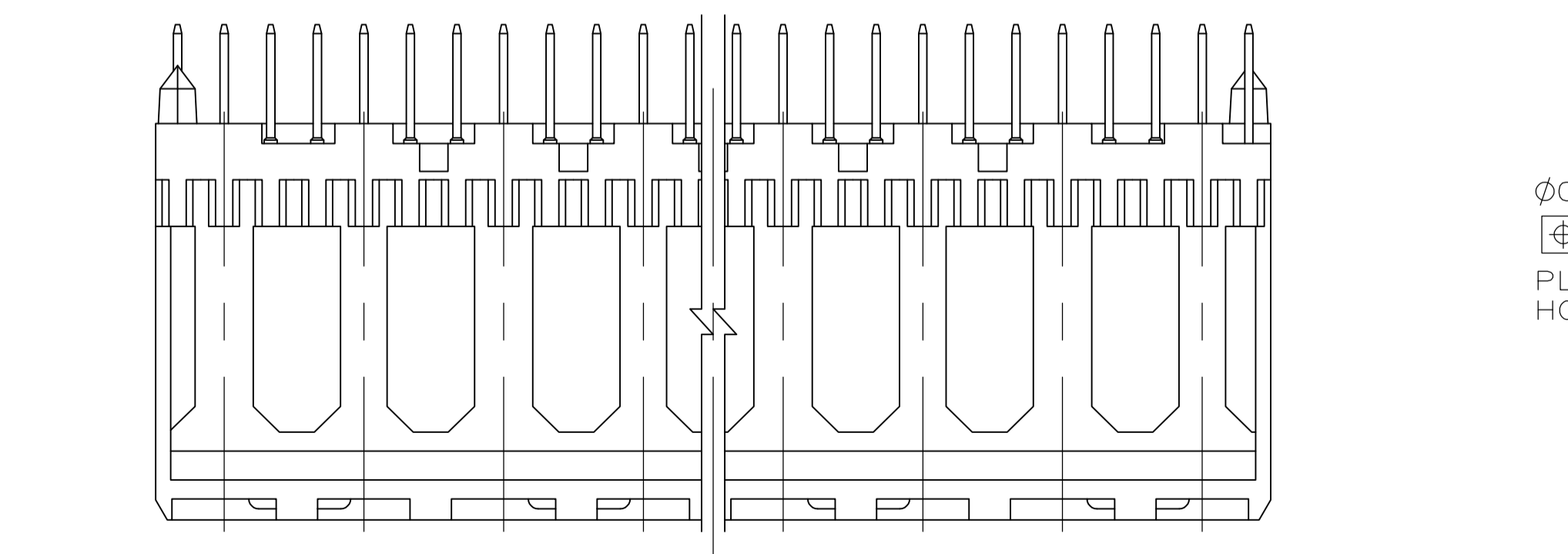
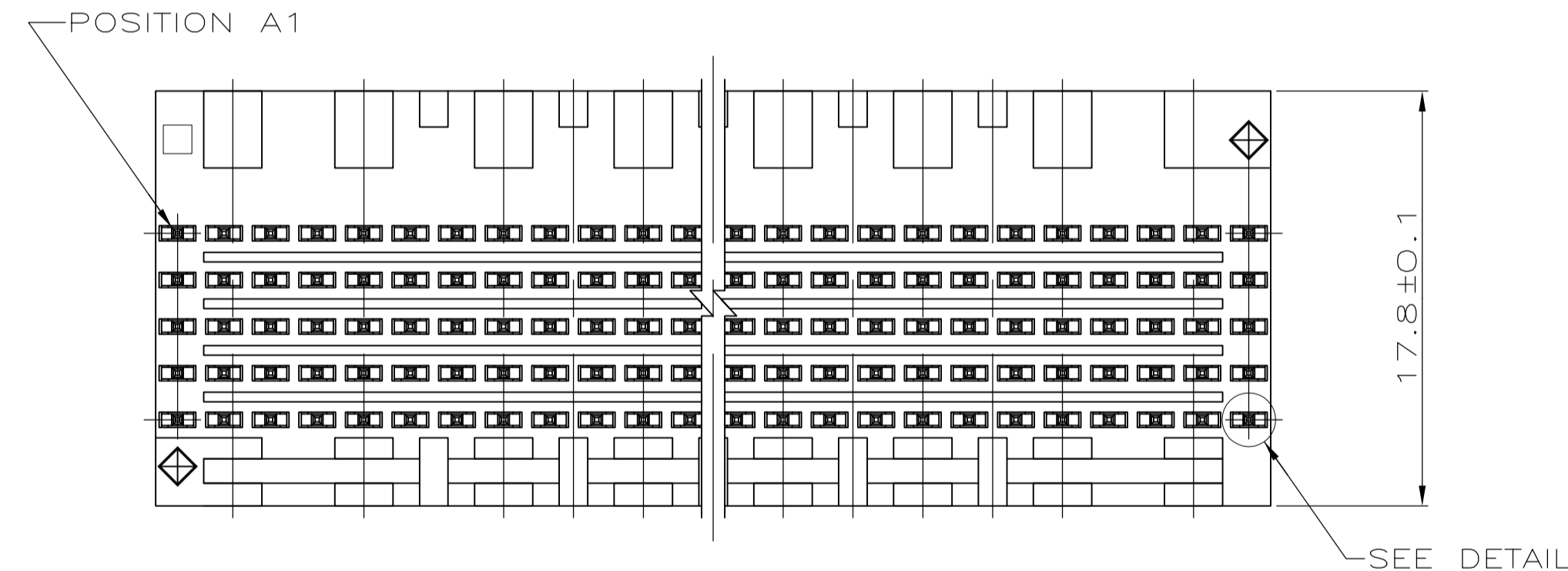
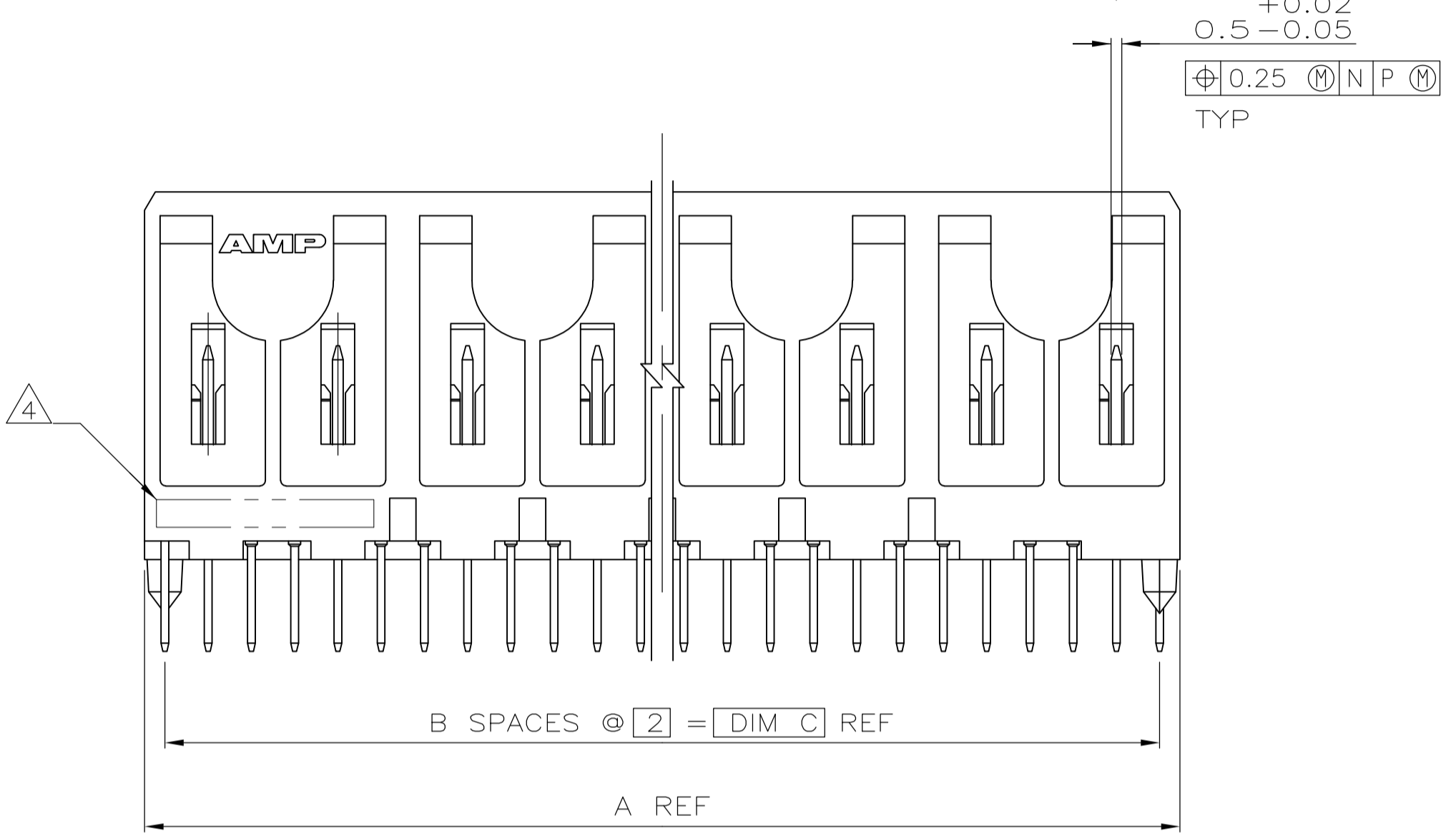
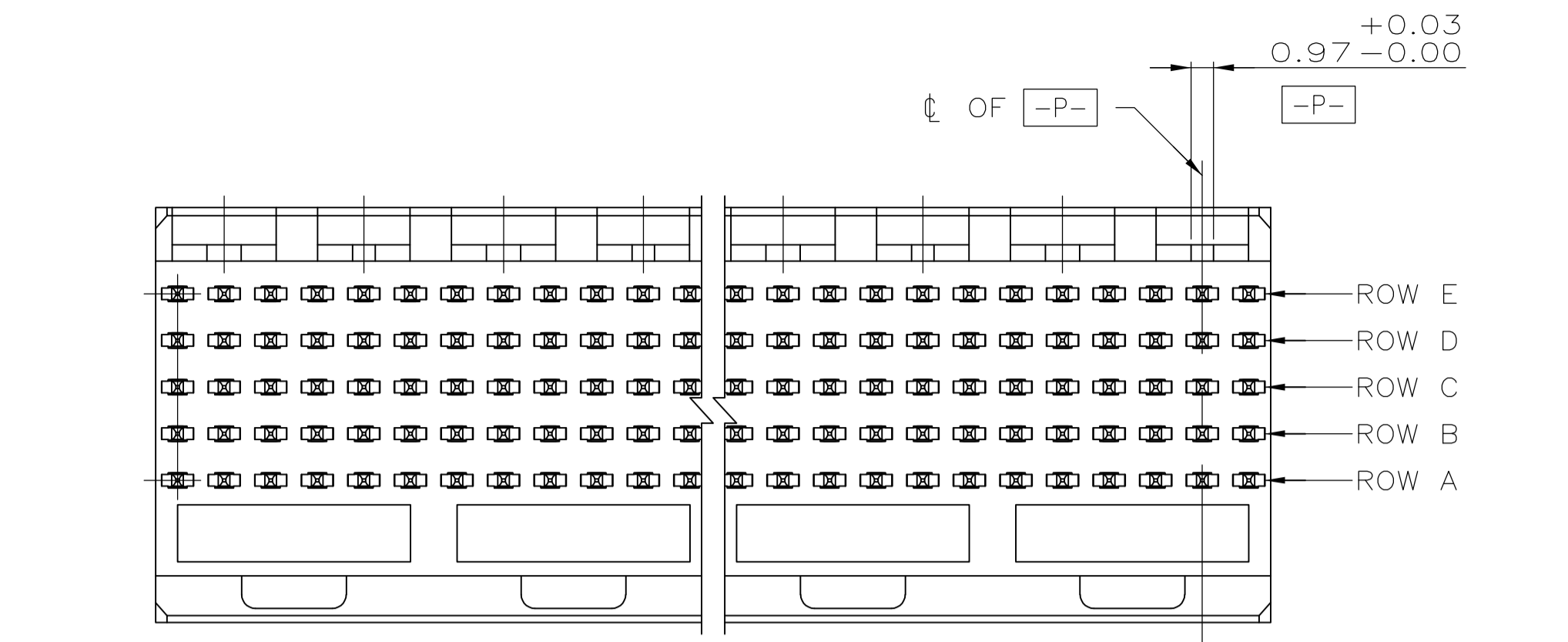

RECOMMENDED CIRCUIT PATTERN (COMPONENT SIDE)

- 1 HOUSING MATERIAL: LIQUID CRYSTAL POLYMER  
COLOR: NATURAL.
- 2 CONTACT MATERIAL: PHOSPHOR BRONZE
- 3 CONTACT FINISH:(A)  
UNDERPLATE (ENTIRE CONTACT):  
0.00127 MIN NICKEL PER SAE-AMS-QQ-N-290  
ON MATING SURFACES:  
CONFORMS TO ALL TESTING SPECIFIED FOR TELCORDIA  
UNCONTROLLED ENVIRONMENT.  
ON LEADS:  
0.00381 MIN MATTE TIN PER ASTM B 545 OVER UNDERPLATE.  
LUBRICATION (MIN MATING SURFACES):  
SURFACE CONDITIONER AFTER PLATING.
- 4 PART MARKING LOCATED APPROXIMATELY AS SHOWN.
- 5 OBSOLETE PARTS: OBSOLETE CIS STREAMLINING PER D.RENAUD/D.SINISI

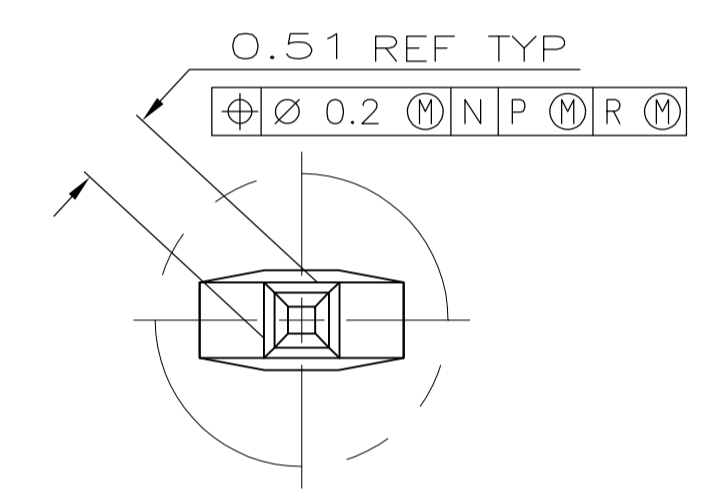

REV	DESCRIPTION	DATE	BY	REV	DESCRIPTION	DATE	BY
1	330	131.88	65	130	OBSOLETE		
2	300	119.88	59	118	OBSOLETE		
3	270	107.88	53	106	OBSOLETE		
4	240	95.88	47	94	OBSOLETE		
5	210	83.88	41	82	OBSOLETE		
6	180	71.88	35	70	OBSOLETE		
7	150	59.88	29	58	OBSOLETE		
8	120	47.88	23	46	OBSOLETE		
9	90	35.88	17	34	OBSOLETE		
10	60	23.88	11	22	OBSOLETE		
11	30	11.88	5	10	OBSOLETE		

THIS DRAWING IS A CONTROLLED DOCUMENT.

DIMENSIONS:	TOLERANCES UNLESS OTHERWISE SPECIFIED:	DIN B MCMMASTER 19NOV04	Tyco Electronics Corporation
mm	0 PLC ± -	CHK R WERTZ 19NOV04	Harrisburg, Pa 17105-3608
	1 PLC ± -	APP'D R WERTZ 19NOV04	NAME
	2 PLC ± 0.13	PRODUCT SPEC	ASSEMBLY, PIN, SIGNAL, VERTICAL, Z-PACK 2mm FB, 5 ROW, SOLDER LEAD
	3 PLC ± -	APPLICATION SPEC	SIZE CAGE CODE DRAWING NO RESTRICTED TO
	4 PLC ± -	WEIGHT	A1 00779 C=5223000
	ANGLES ± -	CUSTOMER DRAWING	SCALE 4:1 SHEET 1 of 1 REV C1