



Chipsmall Limited consists of a professional team with an average of over 10 year of expertise in the distribution of electronic components. Based in Hongkong, we have already established firm and mutual-benefit business relationships with customers from,Europe,America and south Asia,supplying obsolete and hard-to-find components to meet their specific needs.

With the principle of “Quality Parts,Customers Priority,Honest Operation,and Considerate Service”,our business mainly focus on the distribution of electronic components. Line cards we deal with include Microchip,ALPS,ROHM,Xilinx,Pulse,ON,Everlight and Freescale. Main products comprise IC,Modules,Potentiometer,IC Socket,Relay,Connector.Our parts cover such applications as commercial,industrial, and automotives areas.

We are looking forward to setting up business relationship with you and hope to provide you with the best service and solution. Let us make a better world for our industry!



Contact us

Tel: +86-755-8981 8866 Fax: +86-755-8427 6832

Email & Skype: info@chipsmall.com Web: www.chipsmall.com

Address: A1208, Overseas Decoration Building, #122 Zhenhua RD., Futian, Shenzhen, China



N 50 Ω

Attenuator
Plug/Jack

53AS105-K03N3

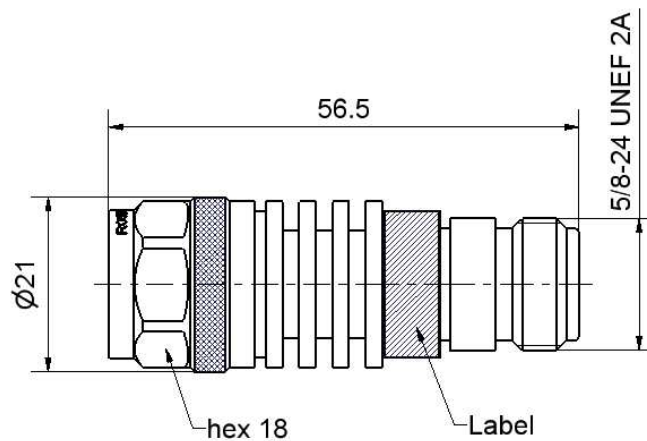

All dimensions are in mm; tolerances according to ISO 2768 m-H

Interface

According to

IEC 60169-16, MIL-PRF-39012, CECC 22210

Documents

N/A

Material and plating

Connector parts

- Center contact - plug
- Center contact - jack
- Outer contact
- Coupling nut
- Dielectric
- Substrate

Material

- Brass
- CuBe
- Brass
- Brass
- PTFE
- ALN

Plating

- Gold, min. 1.27 μm, over nickel
- Gold, min. 1.27 μm, over nickel
- Flash white bronze over silver(e.g. Optargen®)
- Flash white bronze over silver(e.g. Optargen®)

Dieses Dokument ist urheberrechtlich geschützt • This document is protected by copyright • Rosenberger Hochfrequenztechnik GmbH & Co. KG

RF_35/05.10/6.0

N 50 Ω

Attenuator
Plug/Jack

53AS105-K03N3

Electrical data

Impedance 50 Ω
 Frequency DC to 10 GHz
 Return loss ≥ 26.4 dB, DC to 2 GHz
 ≥ 21.2 dB, 2 GHz to 5 GHz
 ≥ 14.0 dB, 5 GHz to 10 GHz
 Attenuation 3 dB ± 0.5 dB, DC to 4 GHz
 3 dB ± 1.0 dB, 4 GHz to 10 GHz
 Center contact resistance ≤ 1 mΩ
 Outer contact resistance ≤ 0.25 mΩ
 Power handling ≤ 5 W at 25°C

Mechanical data

Mating cycles ≥ 500
 Coupling nut retention ≥ 450 N
 Center contact captivation: ≥ 28 N
 Maximum torque 1.70 Nm
 Recommended torque 0.70 Nm to 1.10 Nm

Environmental data

Temperature range -65°C to +125°C
 RoHS compliant

Packing

Standard 1 pce in bag
 Weight 73 g/pce

While the information has been carefully compiled to the best of our knowledge, nothing is intended as representation or warranty on our part and no statement herein shall be construed as recommendation to infringe existing patents. In the effort to improve our products, we reserve the right to make changes judged to be necessary.

Draft	Date	Approved	Date	Rev.	Engineering change number	Name	Date
Kerstin Herzog	05/08/05	Lars Ramtke	16/08/13	b00	12-0878	Marion Striegler	16/08/13
Rosenberger Hochfrequenztechnik GmbH & Co. KG P.O.Box 1260 D-84526 Tittmoning Germany www.rosenberger.de				Tel. : +49 8684 18-0 Fax : +49 8684 18-499 Email : info@rosenberger.de			Page 2 / 2