



Chipsmall Limited consists of a professional team with an average of over 10 year of expertise in the distribution of electronic components. Based in Hongkong, we have already established firm and mutual-benefit business relationships with customers from,Europe,America and south Asia,supplying obsolete and hard-to-find components to meet their specific needs.

With the principle of “Quality Parts,Customers Priority,Honest Operation,and Considerate Service”,our business mainly focus on the distribution of electronic components. Line cards we deal with include Microchip,ALPS,ROHM,Xilinx,Pulse,ON,Everlight and Freescale. Main products comprise IC,Modules,Potentiometer,IC Socket,Relay,Connector.Our parts cover such applications as commercial,industrial, and automotives areas.

We are looking forward to setting up business relationship with you and hope to provide you with the best service and solution. Let us make a better world for our industry!



Contact us

Tel: +86-755-8981 8866 Fax: +86-755-8427 6832

Email & Skype: info@chipsmall.com Web: www.chipsmall.com

Address: A1208, Overseas Decoration Building, #122 Zhenhua RD., Futian, Shenzhen, China



USB mini B jack 90° SMT mount

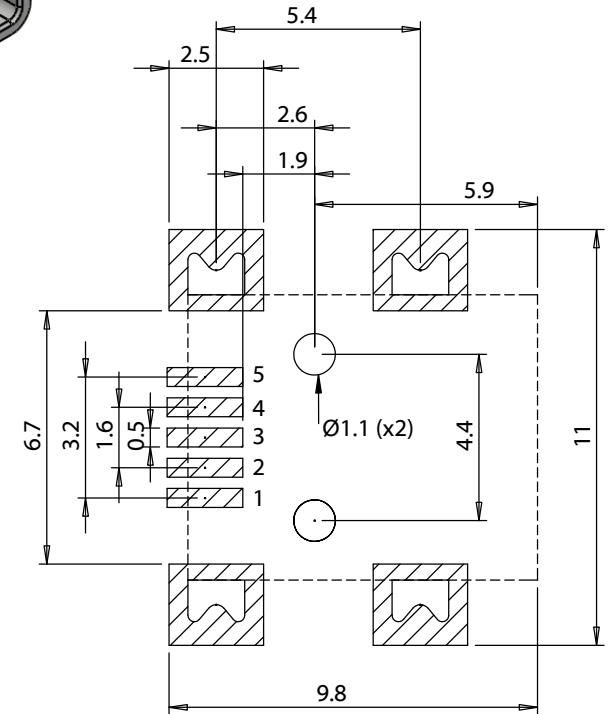
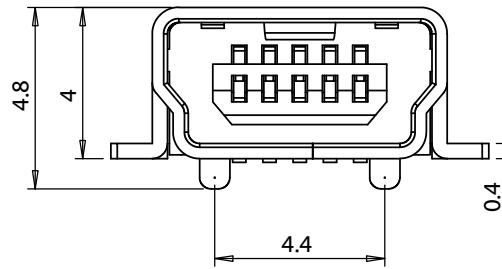
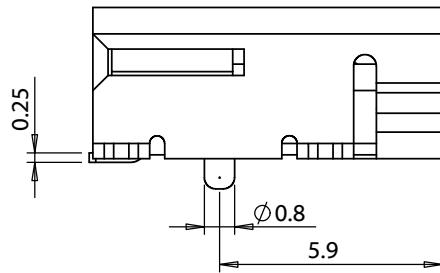
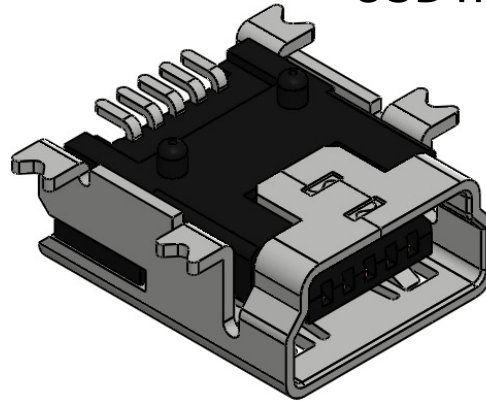
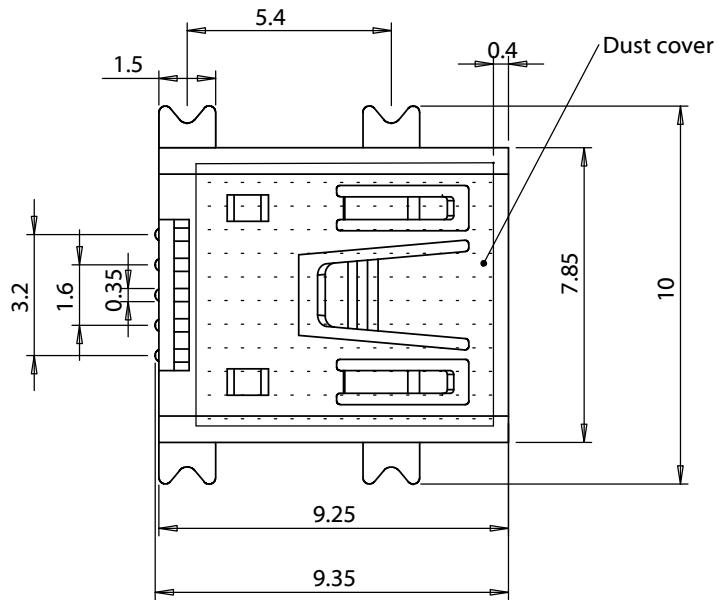

NOTES
RoHS and REACH compliant

TENSILITY

20802 Sockeye Place #130
Bend, OR 97701 USA
tel 541.323.3228 fax 541.323.4202
800 877.670.7118 www.tensility.com

DIMENSIONS ARE IN
MILLIMETERS

TOLERANCES:
Up to 1.0: ± 0.1 mm
1.0 to 10.0: ± 0.2 mm
Over 10.0: ± 0.3 mm

DESCRIPTION:
Connector, USB mini B Jack, SMT mount, 90°, nickel
shell, black insulator

SIZE	PART NUMBER
A	54-00021

SCALE: 1:1

SHEET 1 OF 2

Materials

1. Shell, phosphor bronze, nickel plated
2. Pins, phosphor bronze, 5 μ" gold and tin plating
3. Insulator, Nylon, black

Electrical

Rated voltage: 30 Vdc
 Rated current: 2 A
 Dielectric strength: 1 min @ 500 Vac
 Insulation resistance: 100 MΩ @ 500 Vdc
 Contact resistance: 50 mΩ or less

Mechanical

Insertion force: 3.5 kgf maximum
 Withdrawal force: 0.7 kgf minimum
 Durability: 5000 cycle minimum life; less than 100 mΩ contact resistance, minimum 50 MΩ insulation resistance
 Terminal strength: 0.3 kgf in any direction for 15 seconds without damage or looseness

Soldering

Solderability: 75% minimum coverage when terminals dipped 2 mm in 255 ±5 °C solder bath for 3 ±0.5 seconds
 Solder bath durability: no deformation when immersed in 260 ±5 °C up to surface of the board for 10 seconds or less
 Solder iron durability: no deformation when exposed to 350 ±10 °C for 3 ±0.5 seconds

Environmental

Cold test: -25 ±3 °C for 48 hours without deformation
 Heat test: 70 ±2 °C for 48 hours without deformation
 Humidity test: 40 ±2 °C and humidity between 90 and 98 % for 48 hours without deformation

Operating range

-10 ~ 60 °C

USB mini B jack 90° SMT mount

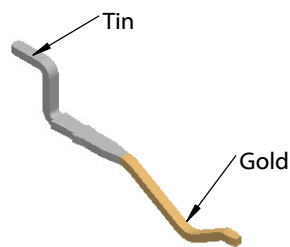
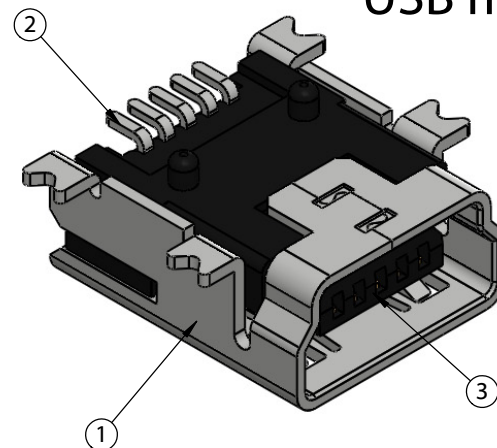

Pin plating detail

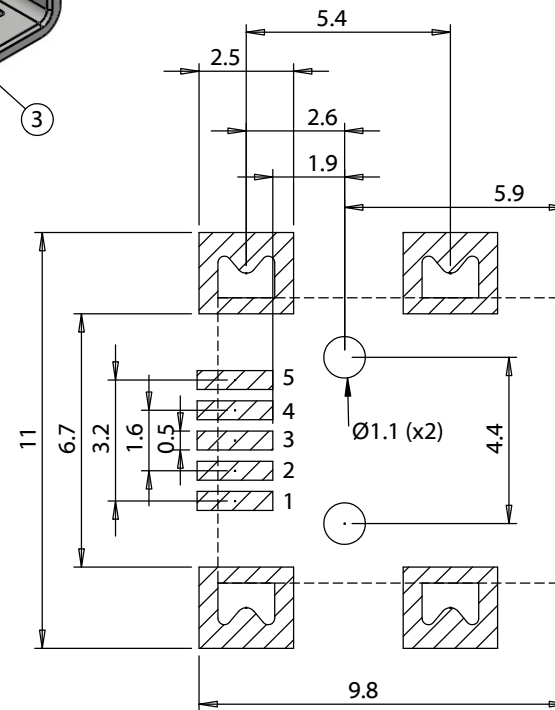

REVISION	DATE	DESCRIPTION
A	9/28/2015	Initial release

PREPARED:
JM 2015.10.02 10:50:07 -07'00'

VERIFIED:
GL 2015.10.02 10:54:31 -07'00'

DIMENSIONS ARE IN MILLIMETERS

TOLERANCES:
 Up to 1.0: ± 0.1 mm
 1.0 to 10.0: ± 0.2 mm
 Over 10.0: ± 0.3 mm

NOTES
 RoHS and REACH compliant

DESCRIPTION:
 Connector, USB mini B Jack, SMT mount, 90°, nickel shell, black insulator

TENSILITY

20802 Sockeye Place #130
 Bend, OR 97701 USA
 tel 541.323.3228 fax 541.323.4202
 800 877.670.7118 www.tensility.com

SIZE A	PART NUMBER 54-00021
-----------	-------------------------

SCALE: 1:1

SHEET 2 OF 2