



Chipsmall Limited consists of a professional team with an average of over 10 year of expertise in the distribution of electronic components. Based in Hongkong, we have already established firm and mutual-benefit business relationships with customers from,Europe,America and south Asia,supplying obsolete and hard-to-find components to meet their specific needs.

With the principle of “Quality Parts,Customers Priority,Honest Operation,and Considerate Service”,our business mainly focus on the distribution of electronic components. Line cards we deal with include Microchip,ALPS,ROHM,Xilinx,Pulse,ON,Everlight and Freescale. Main products comprise IC,Modules,Potentiometer,IC Socket,Relay,Connector.Our parts cover such applications as commercial,industrial, and automotives areas.

We are looking forward to setting up business relationship with you and hope to provide you with the best service and solution. Let us make a better world for our industry!



## Contact us

Tel: +86-755-8981 8866 Fax: +86-755-8427 6832

Email & Skype: info@chipsmall.com Web: www.chipsmall.com

Address: A1208, Overseas Decoration Building, #122 Zhenhua RD., Futian, Shenzhen, China



4

3

2

1

THIS DRAWING IS UNPUBLISHED. RELEASED FOR PUBLICATION ,19 .  
© COPYRIGHT 19 BY AMP INCORPORATED. ALL RIGHTS RESERVED.

LOC	DIST	REVISIONS			
P	LTR	DESCRIPTION	DATE	DWN	APVD
FT	60	E	REDRAWN & REV PER EC 0320-74-97	10 APR 97	-

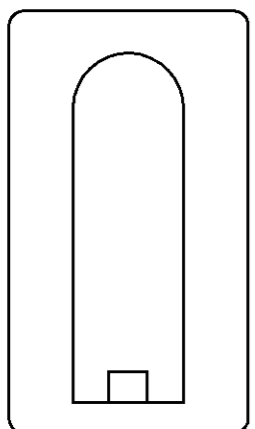

7.92  
[.312]

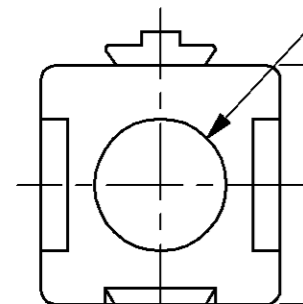

7.92  
[.312]

#8 CLEARANCE HOLE THRU

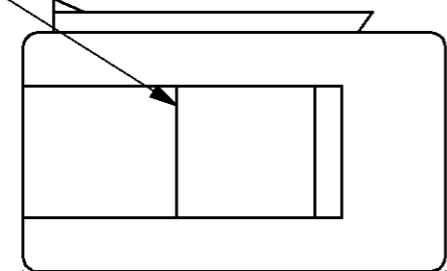

13.97  
[.550]

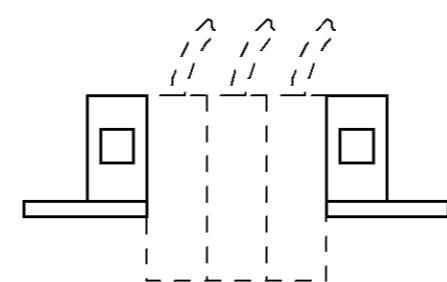

TYP THRU PANEL  
HOLE PATTERN

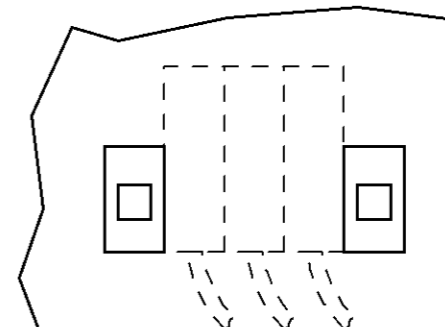
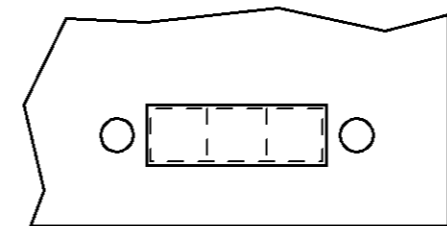

TYP SURFACE  
MTG PATTERN

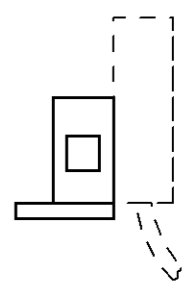

TYP VERTICAL  
MOUNT

54315-1  
PART  
NUMBER

THIS DRAWING IS A CONTROLLED DOCUMENT.		DWN M. BINNER 10 APR 97	<b>AMP</b> AMP Incorporated Harrisburg, PA 17105-3608	
		CHK R. STONE 24 APR 97		
DIMENSIONS: mm [INCHES]		APVD M. MCALONIS 22 MAY 97	NAME	
TOLERANCES UNLESS OTHERWISE SPECIFIED:		PRODUCT SPEC 108-11026	MOUNTING ADAPTER, SERIES 1, POWER LOCK	
0 PLC ±-		APPLICATION SPEC 114-6032	SIZE	RESTRICTED TO
1 PLC ±-		WEIGHT	CAGE CODE	
2 PLC ±0.38 [.015]		CUSTOMER DRAWING	DRAWING NO	
3 PLC ±-		SCALE 4:1	114-6032	
4 PLC ±-		SHEET 1 OF 1	A3 00779 C-54315	
ANGLES ±-		REV E		
MATERIAL POLYCARBONATE, RED				
FINISH -				