



Chipsmall Limited consists of a professional team with an average of over 10 year of expertise in the distribution of electronic components. Based in Hongkong, we have already established firm and mutual-benefit business relationships with customers from,Europe,America and south Asia,supplying obsolete and hard-to-find components to meet their specific needs.

With the principle of “Quality Parts,Customers Priority,Honest Operation,and Considerate Service”,our business mainly focus on the distribution of electronic components. Line cards we deal with include Microchip,ALPS,ROHM,Xilinx,Pulse,ON,Everlight and Freescale. Main products comprise IC,Modules,Potentiometer,IC Socket,Relay,Connector.Our parts cover such applications as commercial,industrial, and automotives areas.

We are looking forward to setting up business relationship with you and hope to provide you with the best service and solution. Let us make a better world for our industry!



Contact us

Tel: +86-755-8981 8866 Fax: +86-755-8427 6832

Email & Skype: info@chipsmall.com Web: www.chipsmall.com

Address: A1208, Overseas Decoration Building, #122 Zhenhua RD., Futian, Shenzhen, China



Section 1

Introduction

1-1 Introducing the 5 1/2 Digit Dual Display Bench Multimeters

NOTE

1. This operation manual contains information and warning that must be followed to ensure user operation safety and to retain the meter safety condition.
2. The term “5492” and “5491” will be used to refer to respective models when descriptions for either model is applied.
3. The term “the meter” will be used to refer to both “5492” and “5491” when descriptions are applied to both models.

 **Precaution!**

TO ENSURE PERSONAL SAFETY AND TO AVOID DAMAGING THE METER AND THE EQUIPMENT CONNECTED, READ “GETTING STARTED” IN SECTION 2-2 BEFORE USING THE METERS.

The Dual Display Multimeter 5492 & 5491 (also referred to as “the meter” in this manual) are 5 1/2 digit multimeters with 120,000 count high resolution. Both meters are designed for bench-top, field service, and system applications with a high performance/price ratio. Complete specifications are provided in Appendix A for 5492 and B for 5491 respectively.

With the RS-232 computer interface (standard), the meter is fully programmable for use on the RS-232 interface.

With the IEEE-488 computer interface (optional) installed, the 5492 is fully programmable for use on IEEE-488.1 interface bus (1987). The meter is also designed in compliance with supplemental standard IEEE-488.2 (1987).

1-2 Features

The main features provided by the meter are:

- A dual, Vacuum Fluorescent Display (VFD) that allows two properties of input signal to be displayed at the same time. (e.g., DC voltage on one display and AC voltage on the other).
- Remote operation via RS-232 interface (standard) or IEEE-488 interface (optional).
- 120,000, 40,000, and 4,000 counts for different measuring rate:
Slow Rate (120,000 counts) – 2 readings/sec;
Medium Rate (40,000 counts) – 5 readings/sec;
Fast Rate (4,000 counts) – 20 readings/sec.
- 1 μ V sensitivity in Vdc measurement.
- True RMS Vac with 20Hz to 100kHz bandwidth for 5492, and 40Hz to 30kHz for 5491.
- (Vac+Vdc) RMS and (Aac+Adc) RMS, calculated.
- Selectable 2-wire and 4-wire resistance measurements.
- Resistance measurements up to 120M Ω with 1m Ω resolution at slow reading rate or up to 300M Ω with 10m Ω and 100m Ω resolution at medium and fast reading rate respectively.
- Wide dc and ac current measurement ranges: 12mA ~ 12A.
- Frequency measurements greater than 1MHz with 0.01Hz best resolution.
- dBm measurement with variable reference impedance from 2 Ω to 8000 Ω and audio power measurement capability.
- Zeroing mode (REL) to offset residual reading before taking a measurement.
- Compare mode to determine if a measurement is within, above, or below a designated range (Hi/Lo/Pass).
- Dynamic recording mode to keep minimum and/or maximum readings of measurements.
- CAL mode to provide electronic closed-case calibration (no internal adjustments).

1-3 Options and Accessories

At the moment, one option is available for 5492 only, which option can be installed at the factory and a field installable retrofit kit option is also available:

- IEEE-488 interface (Option GP5492) provides full programmability. There are two types of programming commands: IEEE 488.2 Common Commands and Standard Commands for Programmable Instruments (SCPI). The SCPI commands used in this device is conformance with the SCPI Standard Version 1993.0.

Standard accessories come with the meter are:

- Power cord
- Protective holsters (Front and Rear)
- Operation Manual
- TL 36* Test leads
- AC 01 Cap for TL 36

*** Maximum Measurement Ratings: 1kVdc, 10A dc or ac rms continuous, and 12A dc or ac rms for 30 seconds maximum.**

Available optional accessories are listed as below:

- TL 35* Test leads
- TH 02 Insulation piercing clip
- AC 02 Lantern tip extension probe for TL 35
- AC 03 Alligator clip
- KC 01 4wire test cable set with Kelvin clippers
- AK 5491 RS-232 PC Link software
- GP5492 IEEE-488 GPIB Interface Upgrade (Only for 5492)
- RK 01 Rack-mount kit (used for single meter)

*** Maximum Measurement Ratings: 1kVdc, 10A dc or ac rms continuous, and 12A dc or ac rms for 30 seconds maximum.**

1-4 How to use this manual

This manual is designed to help the user to get a quick start. Though it is not necessary to read the entire manual to operate the unit effectively, we recommend the manual to be read thoroughly in order to use the meter to its full advantages.

First scan the Tables of contents to be familiar with the outline of the manual. Then read “Getting Started” in Section 2-2. Refer to the appropriate section of the manual as needed. The contents of each section are summarized below.

Section 1. Introduction

Introducing the general information of features, options, accessories, and operation manual for the 5 1/2 digit Dual Display Multimeters.

Section 2. Getting Started

Introducing how to prepare the meter for operation and to start taking basic front panel operations and measurements quickly.

Section 3. Operating the Meter from the Front Panel

Providing a complete description of each operation, which can be performed by using the pushbuttons on the front panel. All related information for operations and functions are grouped together.

Section 4. Measurement Application Examples

Describing how to use the meter in more advanced and sophisticated operations and applications.

Section 5. Calibrating the Meter

Describing the basic information to calibrate the meter if necessary.

Section 6. RS-232 Remote Operation

Describing how to connect the meter to a terminal or a host computer and operate the meter via RS-232 interface.

Section 7. GPIB Remote Operation (5492 Option)

Describing how to connect the meter to a terminal or a host computer and operate the meter via GPIB interface.

Appendices

Appendix A: 5492 Specifications

Appendix B: 5491 Specifications

Appendix C: Maintenance

Getting Started

2-1 Introduction

Section 2 describes the front panel operational keys, displays, input terminals and rear panel of the meter, adjusting handle, explains general operating features.

2-2 Getting Started

- **Unpacking and Inspecting the Meter**

Carefully remove the meter from its shipping container and inspect it for possible damage or missing items. If the meter is damaged or something is missing, contact the place of purchase immediately. Save the container and packing material in case user has to return the meter.

- **Front Panel**

The front panel (shown in Figure 2-1) has three main elements: the input terminals on the left, the primary/secondary displays, and the pushbuttons. The pushbuttons are used to select major functions, ranging operations, and function modifiers. These elements are described in detail in Section 3.

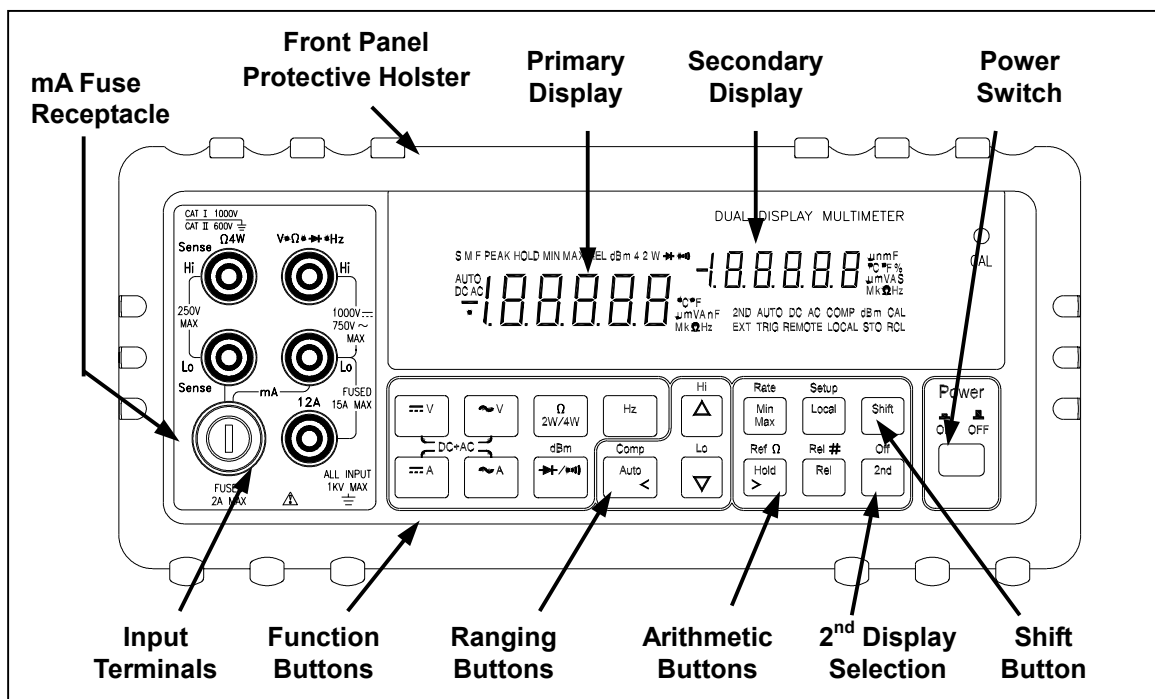

Figure 2-1. Front Panel

- **Rear Panel**

The rear panel (shown in Figure 2-2) contains a line fuse, the power-line cord connector, an RS-232 interface connector, and a cutout for IEEE-488 interface (optional) connector.

- **Line Power**

- Figure 2-2 illustrates the location of the Line Voltage Selector with Fuse Holder housing. If user has already done so, plug the line cord into the connector on the rear of the meter. The meter will operate at any line voltage between 90Vac and 264Vac when “line voltage selector” is set properly, and its frequency range is at 50/60Hz. For operation safety, DO NOT APPLY a line voltage that exceeds the range specified to line cord connector on the rear panel of the meter.

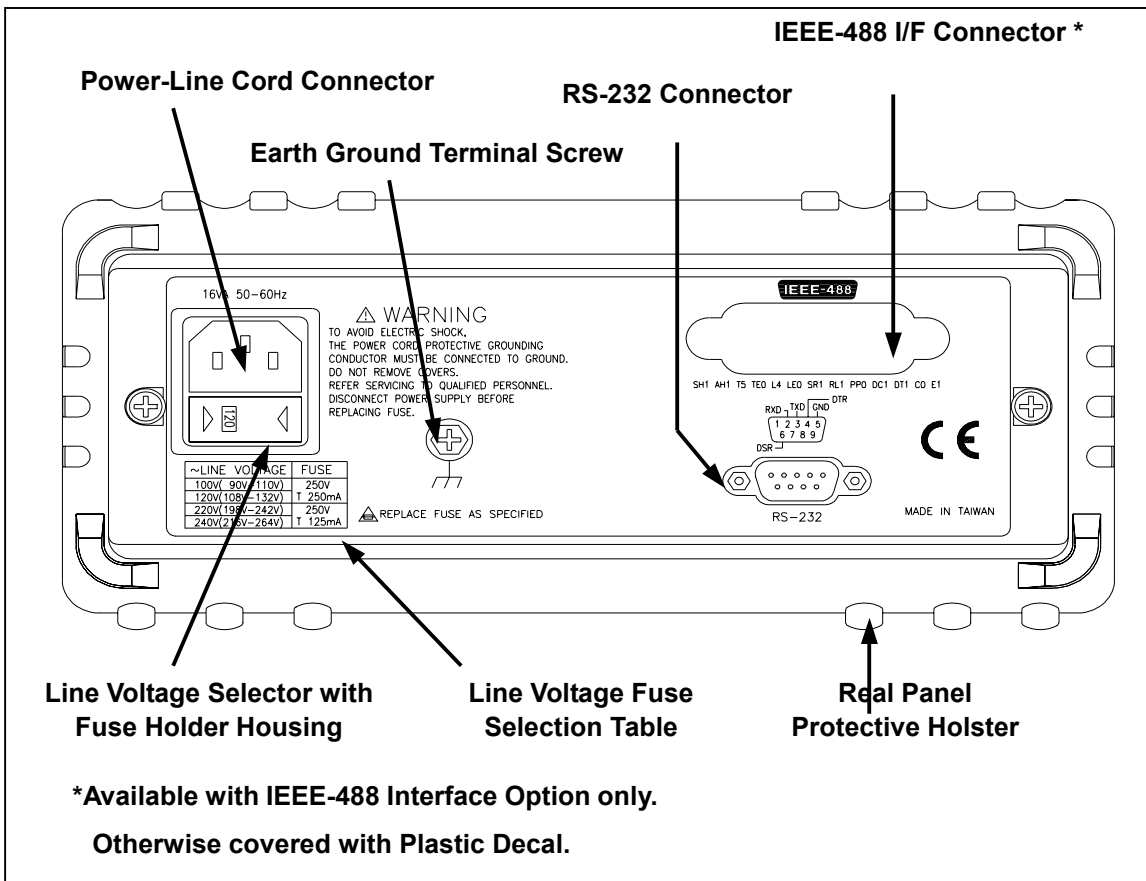

Figure 2-2. Rear Panel

⚠ CAUTION!

BEFORE TURNING THE METER ON, MAKE SURE THE LINE VOLTAGE SELECTOR IS SET TO THE CORRECT POSITION FOR APPLIED LINE VOLTAGE TO THE POWER-LINE CORD CONNECTOR.

- The “line voltage selector” is settable for 100Vac, 120Vac, 220Vac, and 240Vac line voltages.
- The correct fuse ratings: 250mA fuse for 100Vac or 120Vac is selected, and 125mA fuse for 220Vac or 240Vac is selected.

- **Case, Panels and Holsters**

To avoid electric shock or injury, do not operate the meter without panels or case in place.

The meter is provided with special designed anti-slippery protective holsters on the front and rear panel sides (shown in Figure 2-1 and 2-2).

The holsters provide a protection to both front and rear panels of the meter as well as its corners. User may stack up one meter on the top of the other without concerning the slide off of the units (shown in Picture 2-1).

The holsters can be easily removed when install the rack-mounted ears to the meter in order to mount the meter into a 19-inch standard rack. Refer to Section 2-7 for Rack Mounting procedures.



Picture 2-1. Stack up the Meters with Holsters

- **Grounding the Meter**

The meter is grounded through power cord. To avoid electric shock or injury, grounding wire in the power line cord must be connected.

- **Operating in Explosive Atmospheres**

The meter does not provide explosion protection for explosive gasses or arcing components. Do not operate the meter in such circumstances.

- **Adjusting Handle**

For bench-top use, the handle can be adjusted to provide three viewing angles. For viewing positions, pull the ends out to a hard stop (about 1/4 inch on each side) and rotate it to one of four stop positions (shown in Figure 2-3) To remove the handle, adjust it to the vertical stop position and pull the ends all the way out.

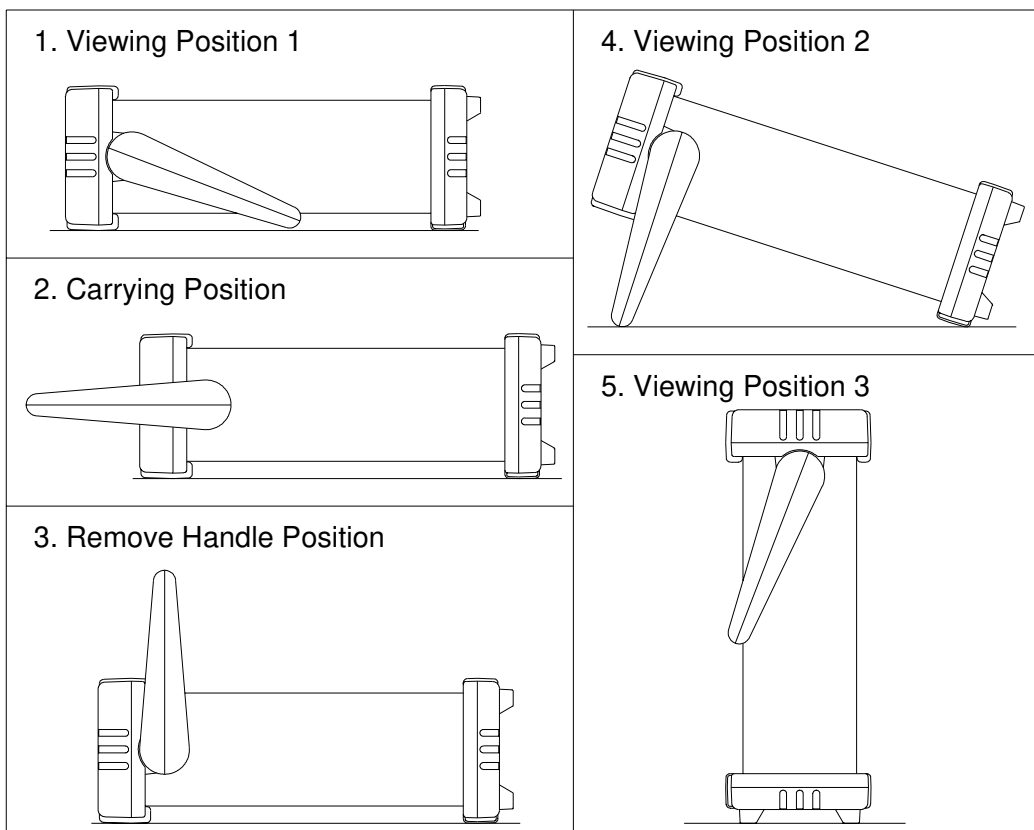

Figure 2-3. Adjusting Handle

2-3 Turning the Meter ON

To turn the meter on, press the **Power** button to “IN” position located on the lower right of the front panel. When the meter is turned on, the primary and secondary displays light for about 2 seconds while an internal self-test running by its digital circuitry. If the **Hold** button is pressed while the power-up sequence is in progress, all segments and annunciators of the entire display remain on until another button is pressed. Then the power-up sequence continues.

After the meter completing its power-up sequence, it resumes the power-up measurement configuration stored in non-volatile memory. The power-up default configuration status set at factory is shown in Table 3-2.

2-4 Selecting Current Input Terminals and Measurement Range

If current (dc or ac) is being measured in the Auto-ranging mode, with a signal input on the 1200mA terminal (5492) or 120mA terminal (5491), the meter will select the range automatically.

If a signal input is applied to the 12A input terminal, the meter will not select the range to 12A automatically. User will need to select the current measurement range to 12A manually.

2-5 Using the Pushbuttons

The meter functions and operations can be selected by pressing the pushbuttons on the front panel select.

A summary of pushbuttons is shown in Figure 2-4.

Pushbuttons can be used in three ways. User can:

- Press a single button to select a function or operation.



EXAMPLE:

 (Press)  to select AC volts for the primary display.

- Press a combination of buttons, one after the other.

EXAMPLE:

  to select AC volts for the primary display, and then

  to select the frequency measurement.

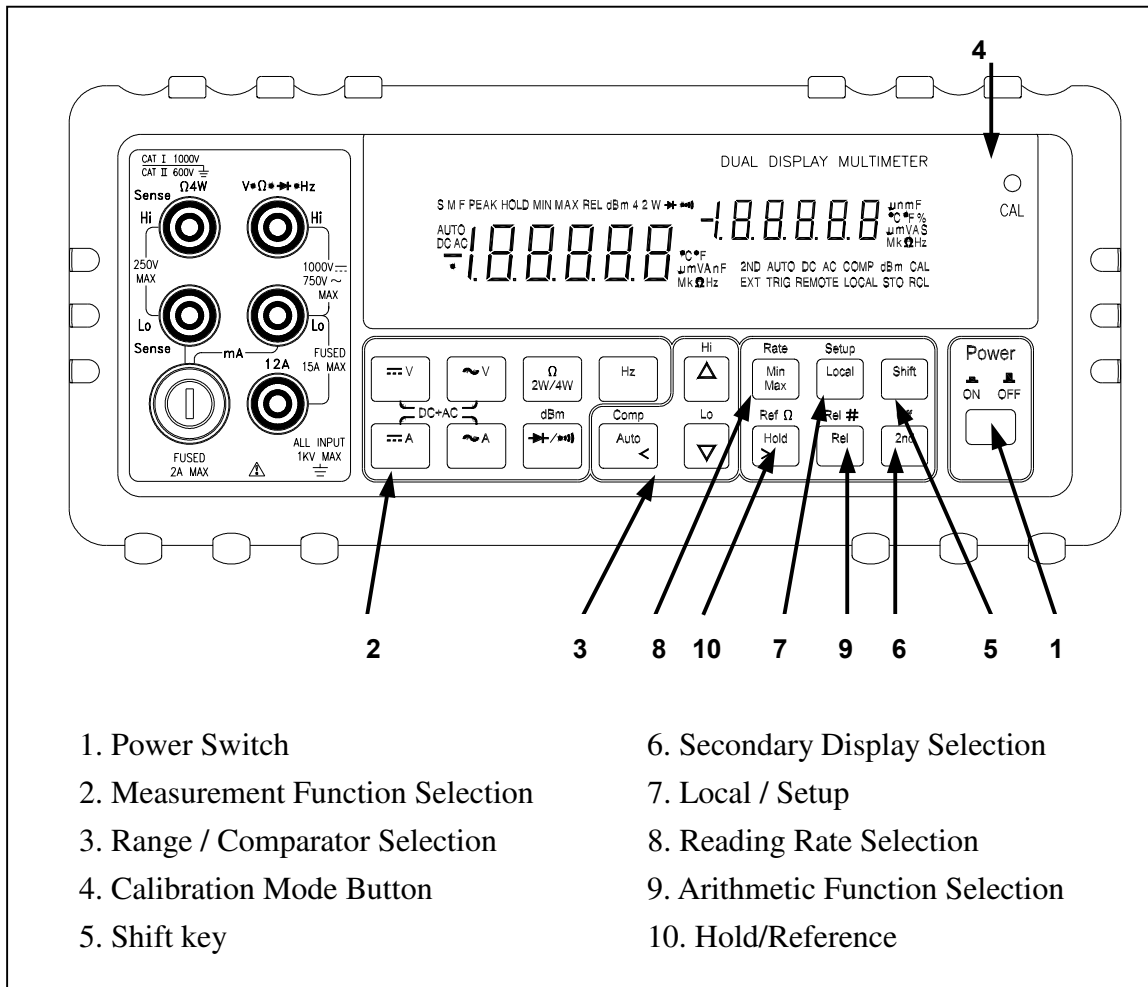





Figure 2-4. Front Panel Pushbuttons

- Press multiple buttons simultaneously.

EXAMPLE:

  and  simultaneously to select True RMS AC volts and DC volts (calculated) on the primary display.

More detail operations are described in Section 3.

2-6 Basic Measurement Examples

This section describes the basic measurement procedures via operations in front panel. These procedures as follows provide the user who wants to get a quick start, but does not want to read the entire manual thoroughly. But it is still recommended to read this manual thoroughly in order to fully utilize all advantages in the meter.

- **Voltage, Resistance or Frequency Measurements**

Press the desired function button and connect the test leads (TL 36 or TL 35 as described in Section 1-3) as shown in Figure 2-5 to measure voltage, resistance, or frequency. The meter will select the appropriate range in the auto-range mode, and an annunciator on the display will indicate measurement units.

NOTE

Excessive error may occur when making measurements with 1 to 10 μ V resolutions after measuring high voltage up to 1000 volts dc. It requires two minutes before making low-level measurements.

- **Current Measurements**

To measure current, connect the test leads to mA input terminal or 12A input terminal for measured current above 1200mA (5492) / 120mA (5491) as shown in Figure 2-6.

Be sure to turn off the power in the circuit to be measured before taking current measurement.

Break the circuit on the groundside to minimize the common mode voltage) to be measured, and place the meter in series at that point.

Turn on power to the circuit, and then read the display. The meter will select the appropriate range automatically, and an annunciator on the display will indicate the units of the measurement value shown.

Turn off power to the circuit and disconnect the meter from the tested circuit.

NOTE

*After making a high current measurement using the 12A input, thermal voltages are generated that may create errors when making high-resolution low-level dc measurements of volts, amps, or ohms.
It requires ten minutes to allow the thermals to settle out before making low-level measurements in order to obtain the best accuracy.*

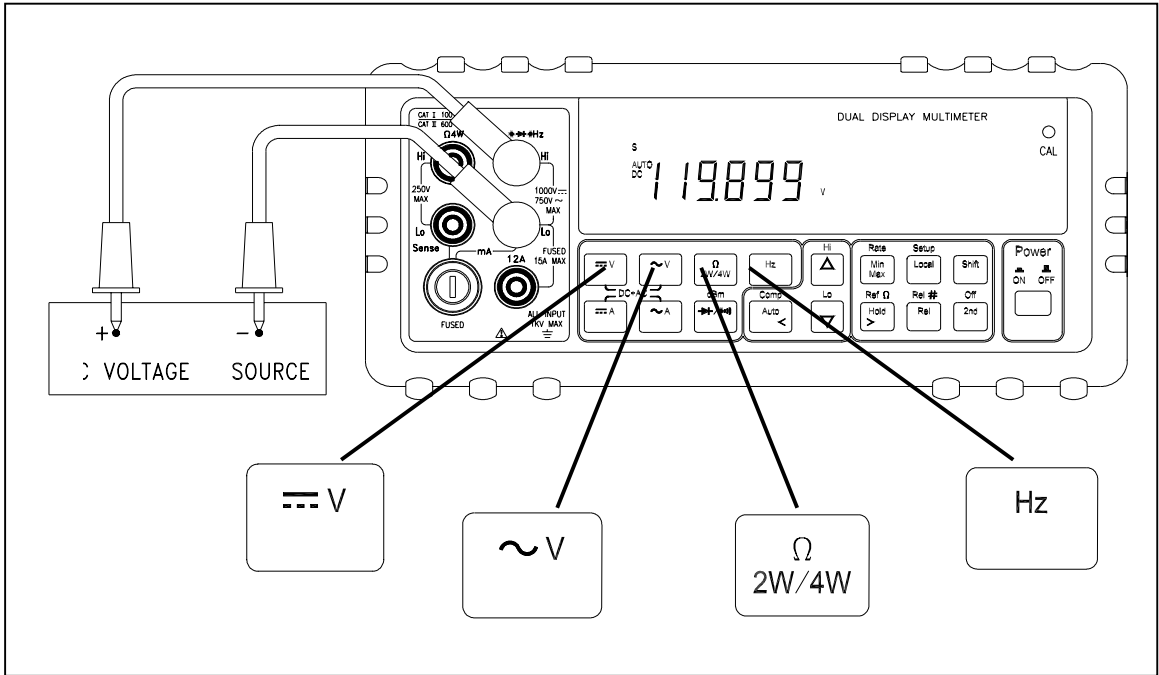

Figure 2-5. Voltage, Resistance or Frequency Measurements

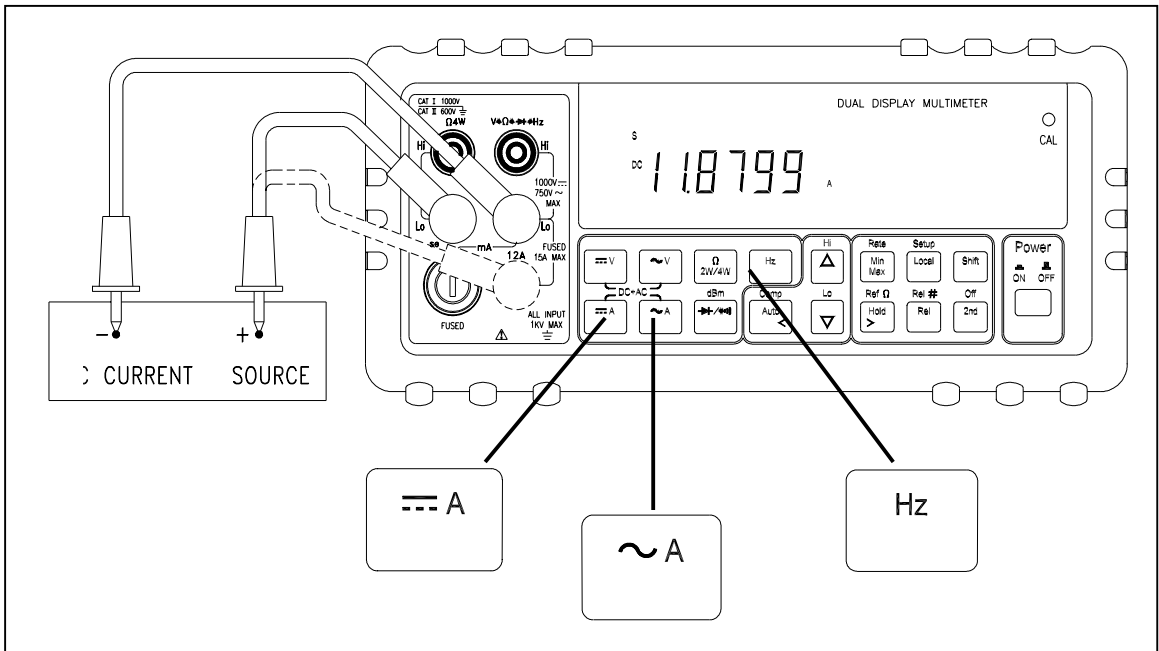



Figure 2-6. Current or Frequency Measurements

- **Diode and Continuity Tests**

Each press of  toggles the diode and continuity functions. Both functions cannot be selected for the secondary display.

The diode test measures the forward voltage of a semiconductor junction at approximately 0.5mA. The beeper generates a single beep tone when the input voltage drops below +0.7V (approximately 1.4k Ω) and generates a continuous beep tone when the input voltage drops below +50mV (approximately 100 Ω).

Readings are displayed in the 1.2V range at the slow measurement rate, and 4V range at the medium and fast measurement rates. “OL” is displayed for voltage above 1.2V at the slow measurement rate and 2.5V at the medium and fast measurement rates. If the diode/continuity test is performed at the slow reading rate, readings are displayed in 10 μ V resolution on the 1.19999V (1.2V) range.

The continuity test measures the resistance of a tested circuit with 2-wire method at approximately 0.5mA and determines whether a circuit is intact. The beeper generates a continuous beep tone when the input resistance value is less than approximately 10 Ω .

For continuity test, the measurement range will be fixed at 120 Ω range if the slow reading rate is selected. The measurement range will be fixed at 400 Ω range if the medium or fast reading rate is selected.

Press  to select diode test function, then connect the test leads across the diode under test as shown in Figure 2-7 (Reversing the polarity will reverse-bias the diode).

Press  again to select continuity test function, then connect the test leads or across the tested circuit as shown in Figure 2-8.

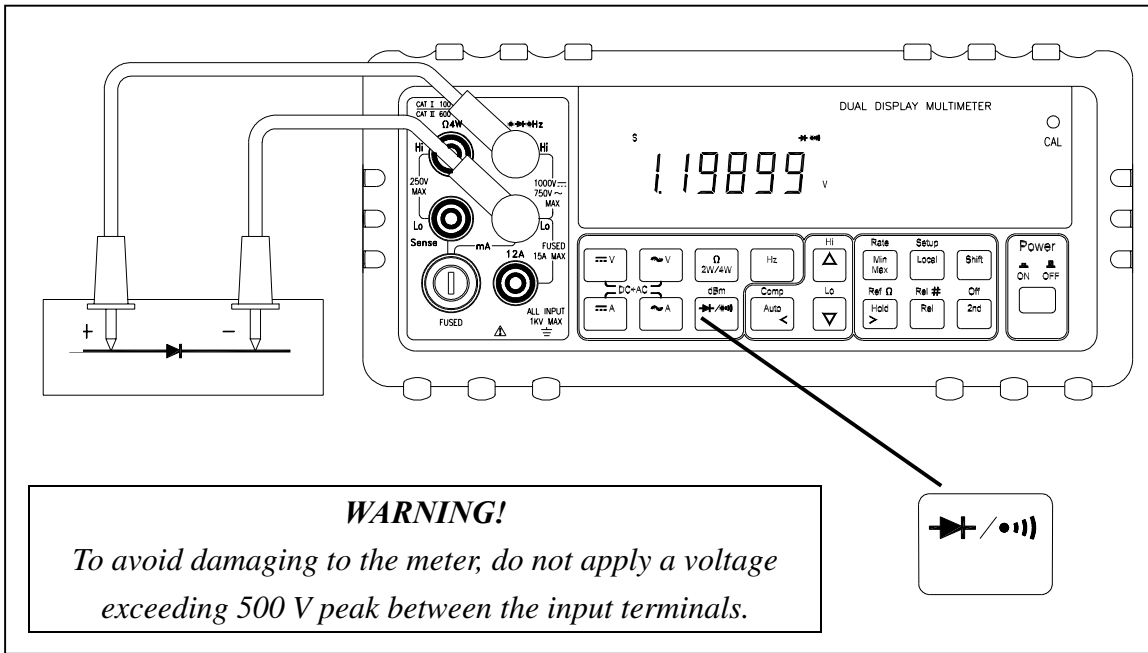

Figure 2-7. Diode/Continuity Test

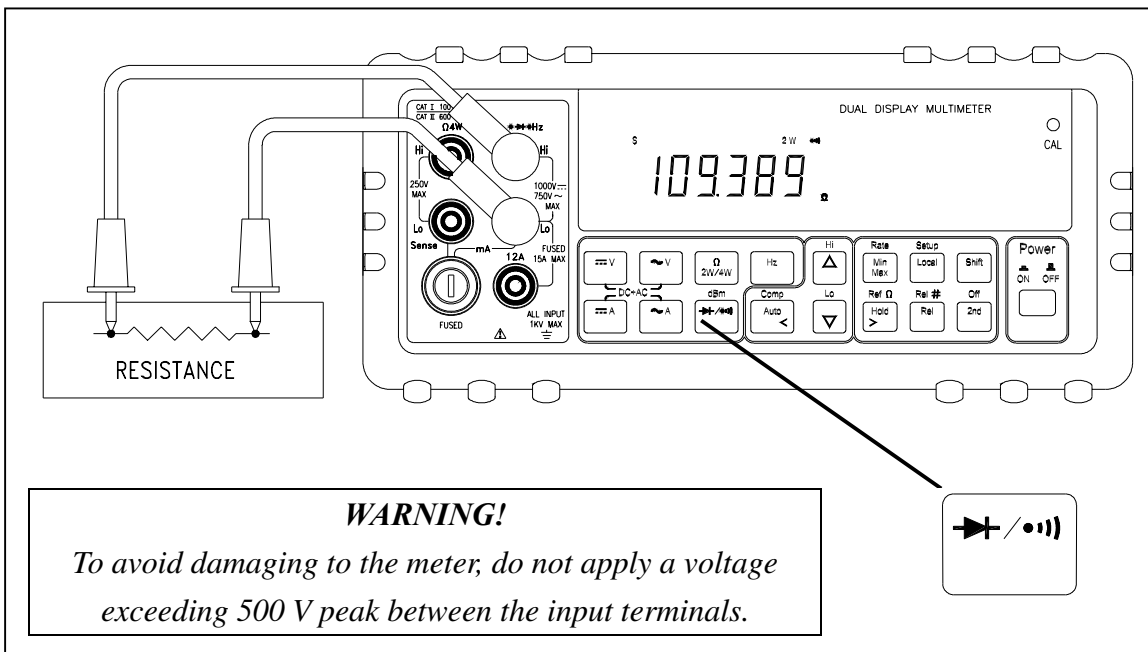

Figure 2-8. 2-Wire Ω /Continuity Test

2-7 Rack Mounting

User can mount the meter into a standard 19-inch rack using RK 01 (for single meter) Rack Mount Kit. The front and rear protective holsters can be removed when mount the meter into a rack.

To install RK 01 rack mount kit, refer to following procedures and Figure 2-9 or the instructions provided with it:

1. Adjusting the handle of the meter to its upward vertical stop position (refer to Figure 2-3) and pull the ends all the way out.
2. Removing two protective holsters out of the front panel and rear panel of the meter.
3. Installing the rack mount ears onto the left and right hand side of the meter frame by using four screws provided with RK 01.
4. Paste two blind plates on the handle hole.
5. Mount the meter with RK 01 into the standard 19" rack.

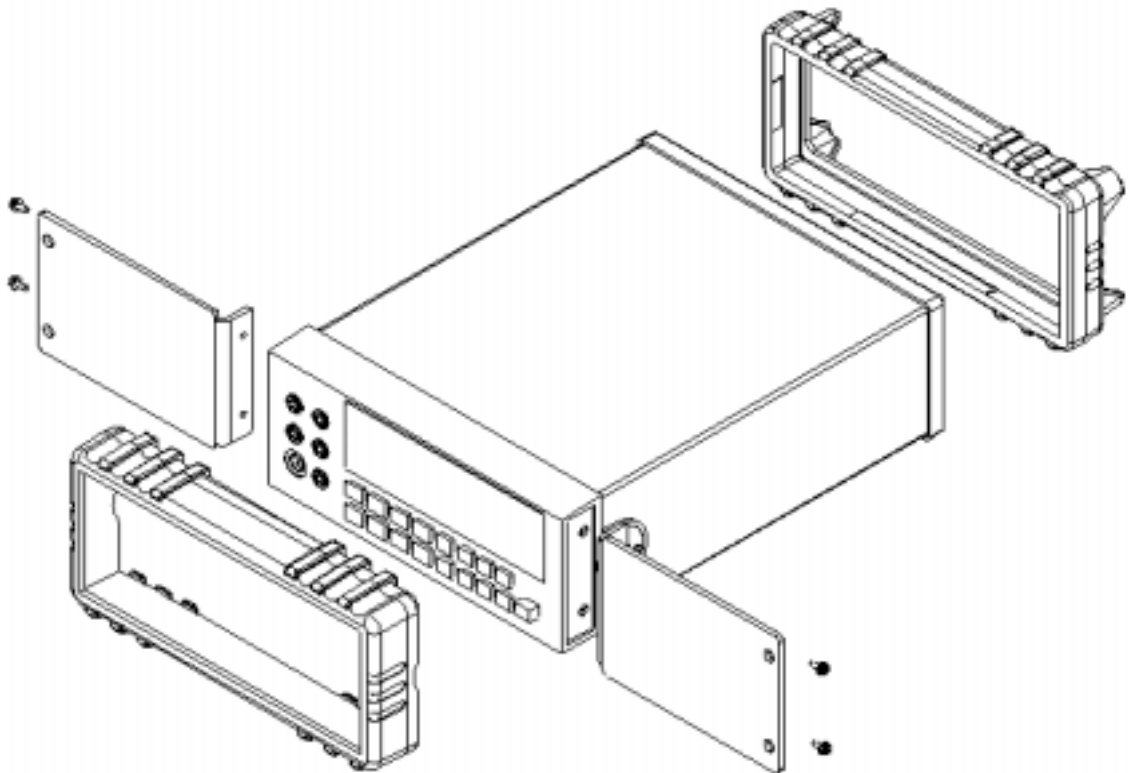

Figure 2-9. Installing the Rack Mount Kit

(This page is subject to be blank)

Front Panel Operation

3-1 Introduction

This section provides a complete description of each operation that can be performed by using the pushbuttons on the front panel.

All related information for operations and functions are grouped together.

3-2 Front Panel Operations

The following operations can be performed from the front panel:

- Select a measurement function (Vdc, Vac, Adc, Aac, resistance, frequency, and diode/continuity test) for the primary and secondary display.
- Take a measurement and display a reading.
- Select the manual or auto-range mode (AUTO)
- Manually select a measurement range for the primary display.
- Select function modifier that cause the meter to display relative readings (REL), minimum or maximum values (MIN MAX) or decibels (dBm and dB), or to enter the Data Hold mode (HOLD) to hold a reading on the primary display.
- Change the measurement rate (SLOW, MEDIUM, FAST)
- Set the dB reference impedance (REF Ω).
- Take a measurement and compare (COMP) it against a tolerance range (Hi, Lo, or Pass).
- Use the "editor" to select from option list, to enter a relative constant base, or to enter a HI-LO range for the compare (COMP) mode.
- Configure the computer interface (RS-232 or IEEE-488).
- Take an audio power reading.
- Send measurement directly to a printer or terminal through the RS-232 interface (RS-232 print only mode)



These and other front panel operations are described in the remainder of Section 3.

3-3 Primary and Secondary Displays

The meter has a 5 1/2 digit, Vacuum-Fluorescent dual display. This display shows measurement readings, annunciator, and messages. The annunciator indicates measurement units and the meter's operating configuration.

The dual display allows you to see two properties (e.g. Vac and frequency) of the input signal you are measuring. The display contains two major parts, primary display and secondary display (See figure 3-1).





The primary display contains of larger digits and annunciators and is located on the left side of the dual display. Readings using the relative (REL), minimum maximum (MIN MAX), touch hold (HOLD), or decibels (dBm) modifier can be shown on the primary display only.

The secondary display contains of a set of smaller digits on the right side of the dual display. To press  then followed by a function button to turn the secondary display on and press  then followed by  to turn the secondary display off.

If the secondary display has been turned on and selected a measurement function for the secondary display, the reading on the primary display will not be affected.

NOTE

If user select  for the primary display, only a diode test voltage will be shown on the secondary display; continuity is restricted to the primary display only.

Neither function modifiers , , , nor  can be selected in the secondary display.

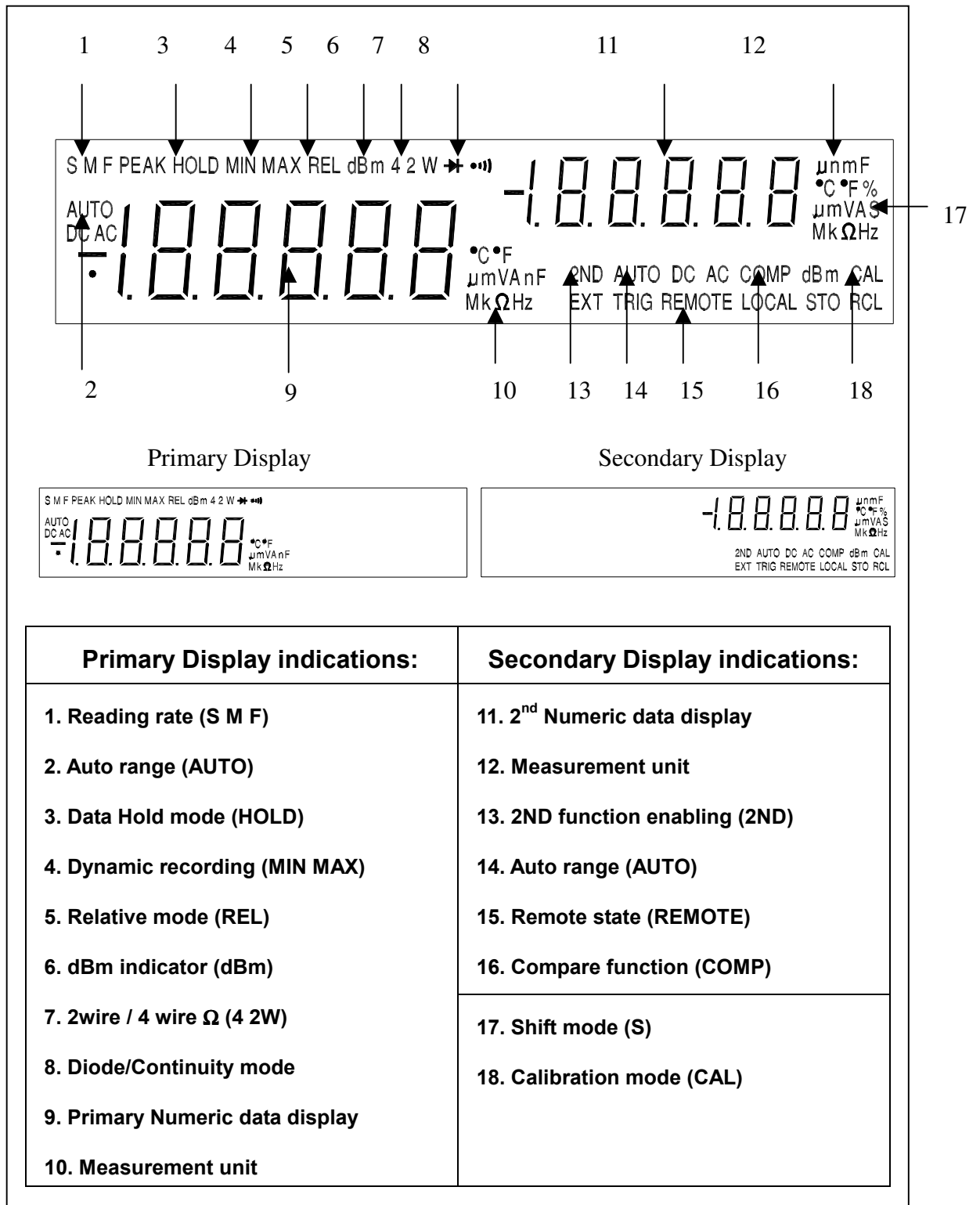

Figure 3-1 Dual Display Illustrations

3-4 Input Terminals

The input terminals, shown in Figure 3-2 are located on the left side of the front panel. The meter is protected against overloads up to the limits shown in Table 3-1. Exceeding these limits poses a hazard to both the meter and operator.

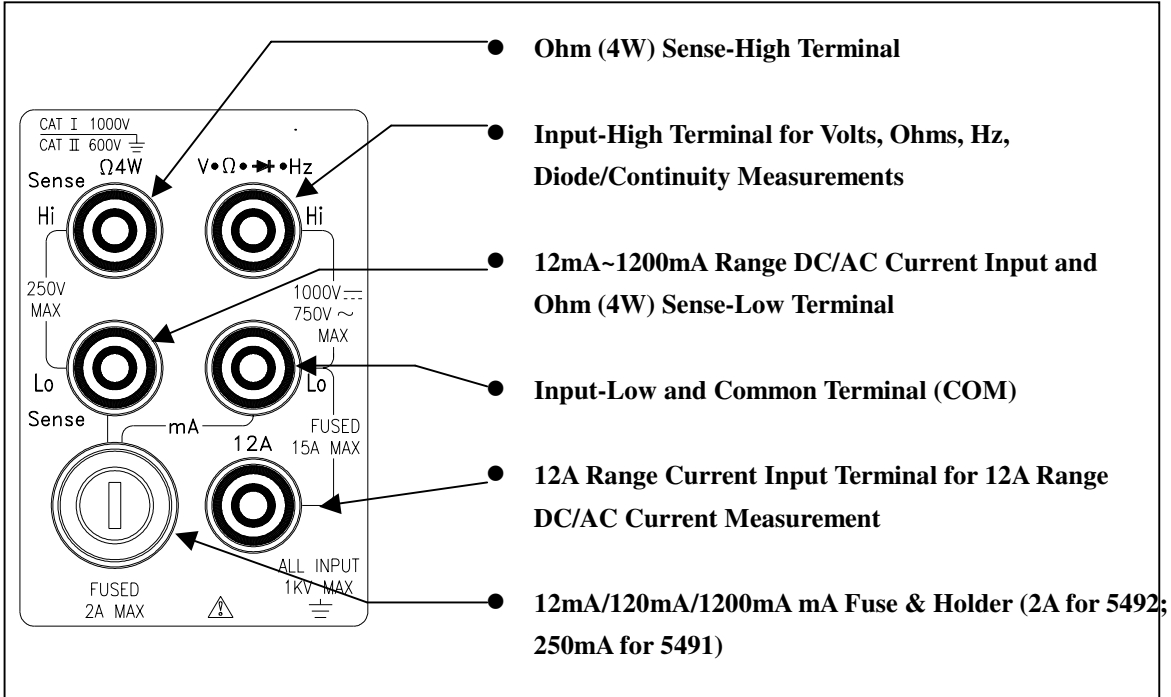

Figure 3-2 Input Terminals

Table 3-1 Input Protection Limits

Function	Input Terminal	Maximum Allowable Input
Vdc	V Ω Hz (Hi) to Lo	1000V dc
Vac, Hz	V Ω Hz (Hi) to Lo	750V ac rms, 1100V peak, 2×10^7 V-Hz normal mode, or 1×10^6 V-Hz common mode
mA, Hz	mA to Lo	1200mA ⁽¹⁾ dc or ac rms
12A, Hz	12A to Lo	12A ⁽²⁾ dc or ac rms
Ω (2W)	V Ω Hz to Lo	500V dc or ac rms
$\rightarrow + \cdot $	V Ω Hz to Lo	500V dc or ac rms
Ω (4W)	Sense Hi to Sense Lo	250V dc or ac rms
All functions	Any terminal to earth	1000V dc or peak ac
(1) Up to 1200mA for 5492; up to 120mA only for 5491		
(2) 10A dc or ac rms continuous, and 12A dc or ac rms for 30 seconds maximum		

3.5 Initialization of Measurement Conditions

- **Power up default configuration Status:**

When turning the meter on, it assumes its power-up configuration. The power-up configuration set at the factory is shown in Table 3-2.





As configuration data for IEEE-488 address, RS-232 baud rate, data bit, stop bit, parity, and echo are stored in the non-volatile memory, they are not changed when power is cycled off and on until the configurations are changed by the user.

Table 3-2 Default configuration Status

Parameters		Default Settings
Function		DCV
Range		Auto Range
Hold		OFF
Reading Rate		Slow Mode (120,000 Counts)
Arithmetic Function		OFF
Constant	Comparator	Hi: 199999 (199999E+0)
		Lo: 000000 (000000E+0)
	REFΩ (Reference Impedance)	600 Ω
	Rel # (Relative Base)	000000E+0
Secondary Display mode		OFF
CAL mode		OFF

3-6 Selecting A Measurement Function

Press a function button shown in Figure 3-3, to select a measurement function.

To select ac + dc total true RMS readings, press  and  or  and  , simultaneously.

When user selects a function, annunciator turns on to indicate the function selected. If the secondary display has been selected and the **2ND** function annunciator remains on when a function button is pressed, the secondary display will display the reading taken from the new measurement function selected.

The summary of ranges and scale values are shown in Table 3-3 and Table 3-4 for slow rate and medium/fast rate respectively.



Table 3-4 Range Scale Value in Medium/Fast Reading Rate

Function	Range Scale	Auto Ranging
	400mV, 4V, 40V, 400V, 1000V	•
$\sim V$, $\overline{\overline{V}}$, $\sim V + \overline{\overline{V}}$	400mV, 4V, 40V, 400V, 750V	•
$\overline{\overline{A}}$, $\sim A$, $\overline{\overline{A}} + \sim A$	40mA, 120mA, 1200mA ⁽¹⁾	•
$\overline{\overline{A}}$, $\sim A$, $\overline{\overline{A}} + \sim A$	12A ⁽²⁾	Manual only
Hz	1200Hz, 12kHz, 120kHz, 1MHz	•
2W Ω , 4W Ω ⁽³⁾	400, 4k, 40k, 400k, 4M, 40M, 300M Ω	•
	2.5V	Fixed range
	2W Ω / 120 Ω (Continuity Mode)	Fixed range
<p>⁽¹⁾ 1200mA for 5492 only.</p> <p>⁽²⁾ 10A dc or ac rms continuous; 12A dc or ac rms for 30 seconds maximum.</p> <p>⁽³⁾ In order to eliminate the noise interference, which might be induced to the test leads, it is recommended to use a shielded test cable for measuring resistance above 120KΩ.</p>		

More operations of selecting a measurement function are described below:

- to select DC voltage measurement
- to select AC voltage measurement
- to select DC current measurement
- to select AC current measurement
- to select frequency measurement
- to select Diode or Continuity measurements by toggling the key
- to toggle in (and out) of the 2W/4W resistance measurements mode
- then to select dBm calculation
- (and) simultaneously to select DC+AC RMS volts calculation
- (and) simultaneously to select DC+AC RMS amps calculation

3-7 Selecting Measurement Range (, , and)

Ranging operations are performed by using the  ,  , and  buttons (see Figure 3-3).

Measurement ranges can be selected automatically by the meter in “Auto-ranging” or manually operated by the user.

- **Auto-Ranging**

Press  to toggle in and out of manual ranging. When meter is in auto-range mode, the AUTO annunciator is lit.

In auto-range, the meter selects the next higher range automatically when a reading is greater than full scale. If no higher range is available, ‘OL’ (overload) will be displayed on primary or secondary display. Likewise, the meter will automatically selects a lower range when a reading is less than approximately 9.5% of the full scale.



- **Manual Range**



Press  to toggle in and out of manual ranging. The range user is in will become the selected range when user enters the manual range mode. In manual range, the meter remains in the selected range regardless of input.

Press  to toggle back to auto-ranging. Manual range can be performed either on readings shown in the primary display or secondary display.



- **Selecting A Measurement Range**

To manually select a range,

-   to toggle in (and out) of the manual ranging mode, or



-   , and 

In manual range mode,

-   , and  to select higher range or lower range to the desired one.

3-8 Selecting Measurement Rate (Rate)

The meter takes measurements at one of three user-selectable rates: **SLOW**, **MEDIUM**, and **FAST**. Rate selection allows user to maximize either measurement speed or noise rejection, which affects accuracy (see Table 3-5). The annunciators “S”, “M”, and “F” (slow, medium, and fast, respectively) indicates selected rate on the primary display.

-   then  to select the different reading rate of measurement.

The meter will be operated in one of the three reading rates sequentially (S → M → F → S → M → F, etc.) if user repeats the above procedures once after the other.

Table 3-5. Display Reading Rates for Single Function Measurements

Reading Rate	Digits	Display Counts ^(1,2)	Readings per Second
SLOW	5 1/2	119,999	2
MEDIUM	4 1/2	39,999	5
FAST	3 1/2	3,999	20







(1) In Vdc 1000V range, display counts will be limited up to 1200.00, 1200.0 and 1200 for slow, medium and fast reading rate respectively;
 (2) In Vac 750V range, 1000Vrms is readable

Note: 1. The reading rate is not selectable when using Frequency function.

Note: 2. At dBm function enable, 0.01dBm resolution for Slow or Medium rate and 0.1dBm for Fast rate.

3-9 Selecting Secondary Display

- **To Enable the Secondary Display Mode**

  then function buttons ( ,  ,  ,  , and )

to enable the secondary display mode.

The  annunciator is in the secondary display area.

- **To Disable the Secondary Display Mode**

  then  to disable the secondary display mode.

The  annunciator is off in the secondary display area. The display remains in **Primary display mode**