



Chipsmall Limited consists of a professional team with an average of over 10 year of expertise in the distribution of electronic components. Based in Hongkong, we have already established firm and mutual-benefit business relationships with customers from,Europe,America and south Asia,supplying obsolete and hard-to-find components to meet their specific needs.

With the principle of “Quality Parts,Customers Priority,Honest Operation,and Considerate Service”,our business mainly focus on the distribution of electronic components. Line cards we deal with include Microchip,ALPS,ROHM,Xilinx,Pulse,ON,Everlight and Freescale. Main products comprise IC,Modules,Potentiometer,IC Socket,Relay,Connector.Our parts cover such applications as commercial,industrial, and automotives areas.

We are looking forward to setting up business relationship with you and hope to provide you with the best service and solution. Let us make a better world for our industry!



## Contact us

Tel: +86-755-8981 8866 Fax: +86-755-8427 6832

Email & Skype: info@chipsmall.com Web: www.chipsmall.com

Address: A1208, Overseas Decoration Building, #122 Zhenhua RD., Futian, Shenzhen, China



AC Filter for PCB Mounting in Flat Housing

Standard- or Medical-Filter



**Description**

- Line filter in standard and medical version
- 1-stage
- standard attenuation

**Approvals**

- VDE Certificate Number: 40004673
- UL File Number: E72928

**Characteristics**

- Cost-saving plastic housing
- Designed for standard applications
- Protection against interference voltage from the mains
- Possible interferences generated in the equipment are strongly attenuated
- For standard applications
- Suitable for use in equipment according to IEC/UL 60950

**Other versions on request**

- Version with wire connection
- Medical version M80

**References**

Alternative: Standard version

**Weblinks**

[pdf datasheet](#), [html-datasheet](#), [General Product Information](#), [Approvals](#), [CE declaration of conformity](#), [RoHS](#), [CHINA-RoHS](#), [REACH](#), [Distributor-Stock-Check](#), [Detailed request for product](#)

**Technical Data**

Ratings IEC	0.5 - 6,5 A @ Ta 40 °C / 250VAC; 50 Hz
Ratings UL/CSA	0.5 - 6.5 A @ Ta 40 °C / 125VAC; 60 Hz
Leakage Current	standard < 0.25 mA (250 V / 60 Hz) medical < 5 µA (250 V / 60 Hz)
Dielectric Strength	> 1.7 kVDC between L-N > 2.7 kVDC between L/N-PE Test voltage (2 sec)
Allowable Operation Temperature	-25 °C to 85 °C
Climatic Category	25/085/21 acc. to IEC 60068-1
Protection Class	Suitable for appliances with protection class I acc. to IEC 61140
Terminal	For PCB mounting , tin-plated
Material: Housing	Thermoplastic, black, UL 94V-0

Line Filter	Standard and Medical Version, IEC 60939, UL 1283, CSA C22.2 no. 8 <a href="#">Technical Details</a>
MTBF	> 200'000h acc. to MIL-HB-217 F

Detailed information on product approvals, code requirements, usage instructions and detailed test conditions can be looked up in [General Product Information](#)

**Dimension**

Case 27P

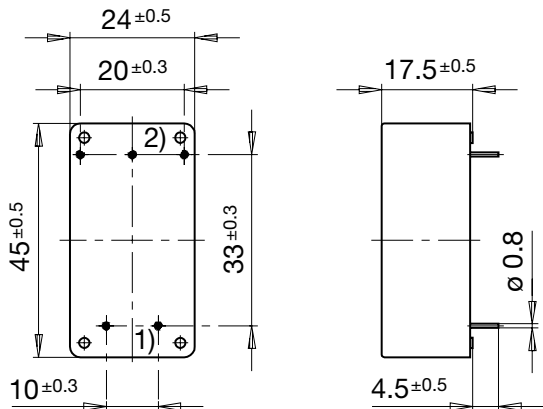

Case 27-1P

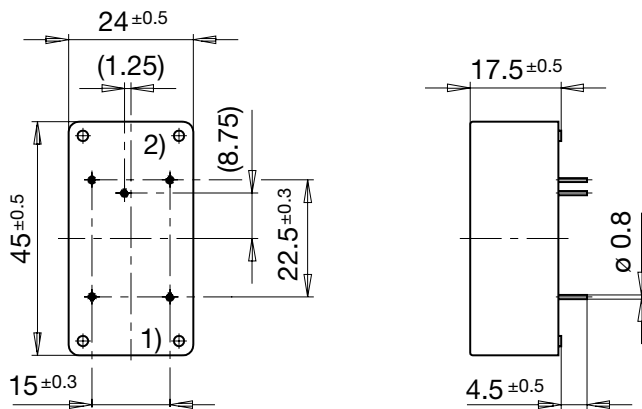

1) Line  
2) Load

**Diagrams**

S2 standard version

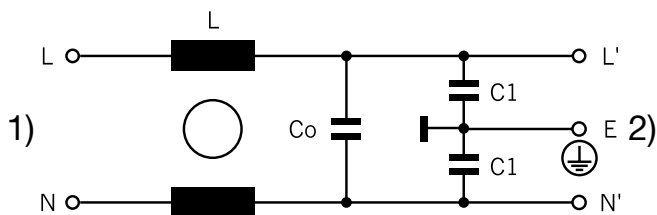

1) Line  
2) Load

S3 standard version

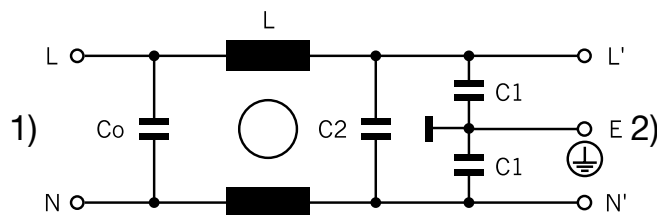

1) Line  
2) Load

S4 medical version

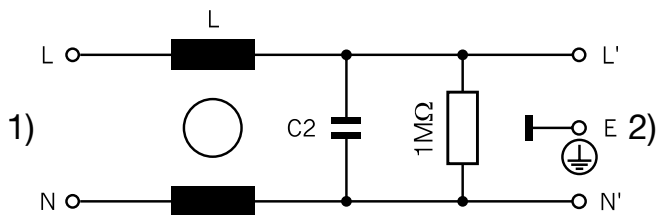

1) Line  
2) Load

S5 medical version

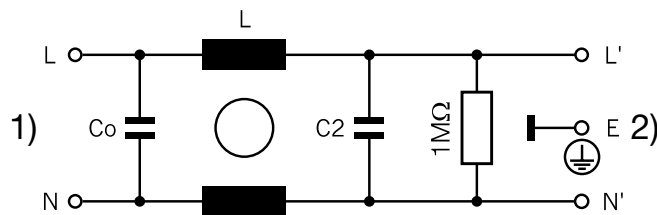

1) Line  
2) Load

**Attenuation Loss**

----- 50Ω differential mode    \_\_\_\_\_ 50Ω common mode

Standard version

0.5 A

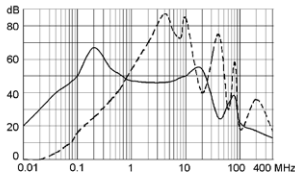

1 A

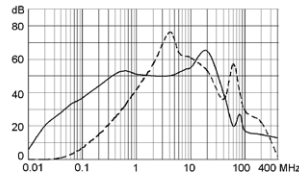

1.6 A

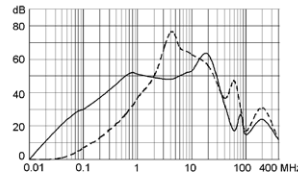

2.5 A

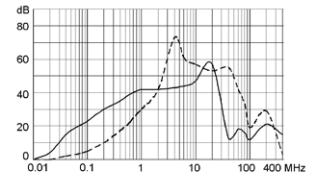

4 A

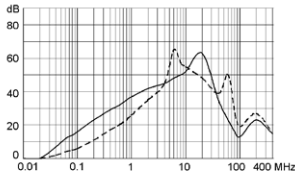

6.5 A

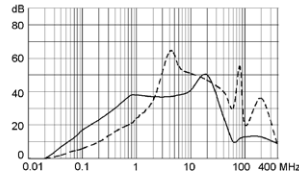

0.8 A

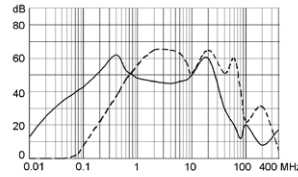

Medical version (M5)

0.5 A

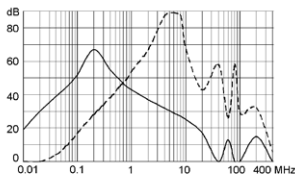

1 A

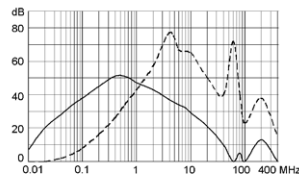

1.6 A

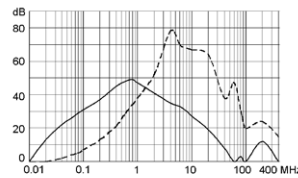

2.5 A

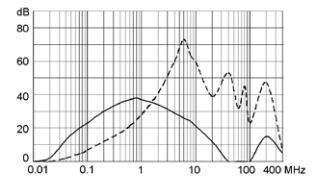

4 A

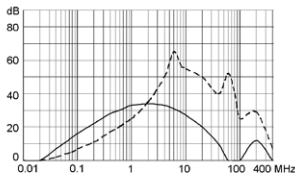

6.5 A

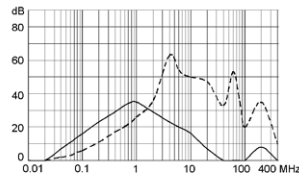

0.8 A

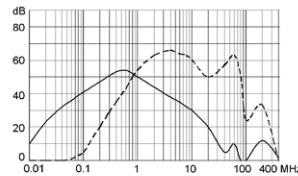

**All Variants**

Rated Current [A]	Filter-Type	L [mH]	Co / C2 (X2) [µF]	C1 (Y2) [nF]	Diagram	Weight [g]	Housings	Order Number
0.8	Standard Version	2 x 20	0.068/0.015	2.2	S3	32 g	27-1P	5500.2020
0.5	Standard Version	2 x 40	0.1	2.2	S2	32 g	27P	5500.2014
1	Standard Version	2 x 10	0.1	2.2	S2	32 g	27P	5500.2015
1.6	Standard Version	2 x 6	0.1	2.2	S2	32 g	27P	5500.2016
2.5	Standard Version	2 x 2	0.1	2.2	S2	32 g	27P	5500.2017
4	Standard Version	2 x 1	0.1	2.2	S2	32 g	27P	5500.2018
6.5	Standard Version	2 x 1	0.1	2.2	S2	32 g	27P	5500.2019
0.8	Medical Version (M5)	2 x 20	0.068/0.015	-	S5	38 g	27-1P	5500.2129
0.5	Medical Version (M5)	2 x 40	0.1	-	S4	32 g	27P	5500.2127
1	Medical Version (M5)	2 x 10	0.1	-	S4	32 g	27P	5500.2130
1.6	Medical Version (M5)	2 x 6	0.1	-	S4	32 g	27P	5500.2131
2.5	Medical Version (M5)	2 x 2	0.1	-	S4	32 g	27P	5500.2132
4	Medical Version (M5)	2 x 1	0.1	-	S4	32 g	27P	5500.2133
6.5	Medical Version (M5)	2 x 1	0.1	-	S4	38 g	27P	5500.2128

Most Popular.

Availability for all products can be searched real-time: <http://www.schurter.com/en/Stock-Check/Stock-Check-SCHURTER>

---

**Packaging unit**      70 Pcs

---