



Chipsmall Limited consists of a professional team with an average of over 10 year of expertise in the distribution of electronic components. Based in Hongkong, we have already established firm and mutual-benefit business relationships with customers from,Europe,America and south Asia,supplying obsolete and hard-to-find components to meet their specific needs.

With the principle of “Quality Parts,Customers Priority,Honest Operation,and Considerate Service”,our business mainly focus on the distribution of electronic components. Line cards we deal with include Microchip,ALPS,ROHM,Xilinx,Pulse,ON,Everlight and Freescale. Main products comprise IC,Modules,Potentiometer,IC Socket,Relay,Connector.Our parts cover such applications as commercial,industrial, and automotives areas.

We are looking forward to setting up business relationship with you and hope to provide you with the best service and solution. Let us make a better world for our industry!



Contact us

Tel: +86-755-8981 8866 Fax: +86-755-8427 6832

Email & Skype: info@chipsmall.com Web: www.chipsmall.com

Address: A1208, Overseas Decoration Building, #122 Zhenhua RD., Futian, Shenzhen, China



55300 Flat Pack Rotary Hall Sensor

RoHS



Description

The Littelfuse 55300 Series of rotary absolute position sensors provide angular measurement between 0 and 360 degrees. This unit is activated by a remote magnet, thus allowing a larger stack up of mechanical tolerances that are not feasible with the integral magnet version 55250. The internal design of the sensor uses non-contact magnetic Hall effect technology with options of analog or PWM output signals. This sensor is immune to the performance limitations of the wiper based products that are associated with mechanical wear or contamination.

The 55300 package design commonly finds applications within all types of vehicle and industrial segments and designed to operate in the harsh environments of the industrial and commercial vehicle, the sensor has an operating temperature range between -40°C and 105°C. This unit incorporates automotive grade EMI/EMC and reverse battery polarity protection, as well as commercial grade 20 AWG-TXL automotive wire and the option of a Molex type sealed connector.

Dimensions

Dimensions in mm

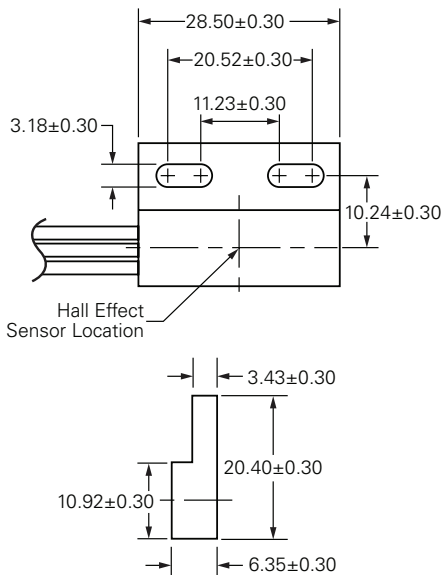

Actuator Magnet Rotation

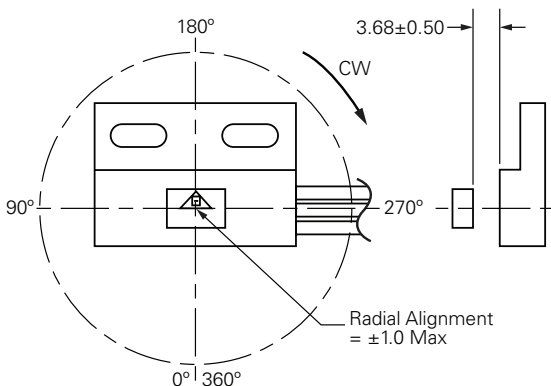

Actuator Magnet

57300-000 (Supplied with Sensor)

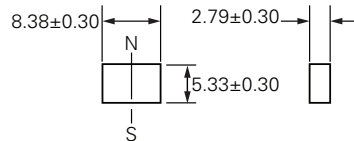

Features

- 360° Angular sensing range
- Absolute rotary position sensing
- Analog output
- Non-contact measuring
- EMC protection

Benefits

- Long life - no wear components
- High speed
- Unaffected by harsh environments
- Compact robust package

Applications

- Absolute rotary encoding
- Pedal position
- Shaft position
- Lever position
- Float level sensing
- Non-contact potentiometer

55300 Flat Pack Rotary Hall Sensor

Specifications

Hall Effect Device		Rotational Analog Output	
Operating Voltage	Recommended	Vdc	4.5 to 5.5
Over Voltage	Absolute Max ¹	Vdc	20
Reverse Voltage	Absolute Max ¹	Vdc	-10
Supply Current		mA - max.	16
Output Current		mA - max.	-8 to +8
Programmed Output Voltage Range		Vdc	0.5 to 4.5
Programmed Sensing Range		Degrees	360
Resolution		Degrees	0.11
Accuracy ²		Degrees	±4
Response Time		ms-Max	4
Start-up Time		ms-Max	15
Temperature	Operating	°C	-40 to +105
Actuator Positional Tolerances	Air Gap ³	mm	3.68 ±0.50
	Radial Alignment ³	mm	±1.0
Pin Out	Size	AWG	20
	Insulation	SAE	J-1128, Type TXL
	Length	mm	300

Notes:

1. This is a stress rating only. Functional operation is not implied.
2. When used in conjunction with the supplied 57300-000 actuator under typical conditions. Accuracy is affected by the sensor and actuator alignment, air gap and the presence of external magnetic fields or materials. Consult Littelfuse for details.
3. When used in conjunction with the supplied 57300-000 actuator.

Output Signal

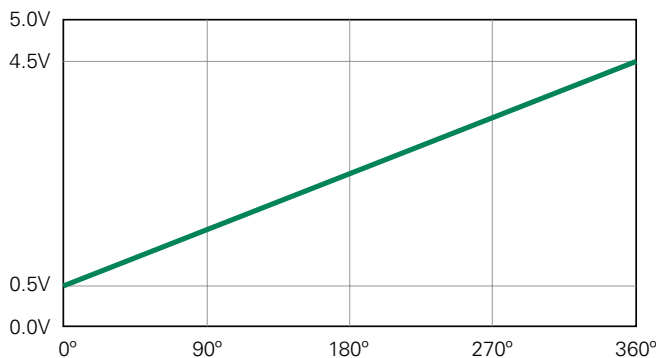

Customization Options

Customized versions available. Contact Littelfuse for details.

- Angular sensing range
- Output type: Analog, PWM, or SPI
- Connectors and terminals
- Wire type and length
- Magnetic actuators

55300 Flat Pack Rotary Hall Sensor

Part Numbering System

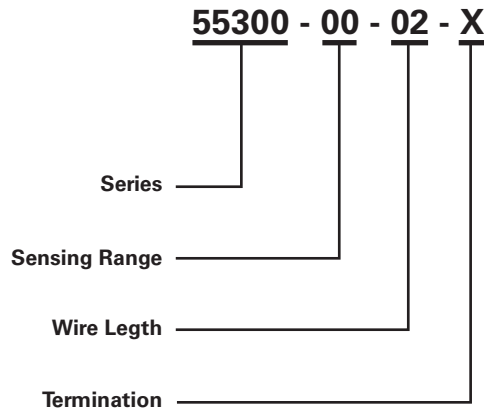

Termination Options

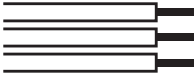
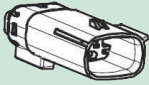
Select Option	Description		Color	Function
A	Stripped Leads		Black White Red	Ground Signal V (in)
C	Molex Connector MX 150 33481-0301		Black White Red	Pin 1: Black/Ground Pin 2: White/Signal Pin 3: Red/V(in)

Packaging

Packaging Option	Packaging Specification	Quantity	Quantity and Packaging Code	Taping Width
Bulk	Bulk	500	N/A	N/A