



Chipsmall Limited consists of a professional team with an average of over 10 year of expertise in the distribution of electronic components. Based in Hongkong, we have already established firm and mutual-benefit business relationships with customers from,Europe,America and south Asia,supplying obsolete and hard-to-find components to meet their specific needs.

With the principle of "Quality Parts,Customers Priority,Honest Operation,and Considerate Service",our business mainly focus on the distribution of electronic components. Line cards we deal with include Microchip,ALPS,ROHM,Xilinx,Pulse,ON,Everlight and Freescale. Main products comprise IC,Modules,Potentiometer,IC Socket,Relay,Connector.Our parts cover such applications as commercial,industrial, and automotives areas.

We are looking forward to setting up business relationship with you and hope to provide you with the best service and solution. Let us make a better world for our industry!



Contact us

Tel: +86-755-8981 8866 Fax: +86-755-8427 6832

Email & Skype: info@chipsmall.com Web: www.chipsmall.com

Address: A1208, Overseas Decoration Building, #122 Zhenhua RD., Futian, Shenzhen, China



556-003-000-201 ±.002
CAVITY NO. .156

556-004-000-201

556-005-000-201

556-006-000-201

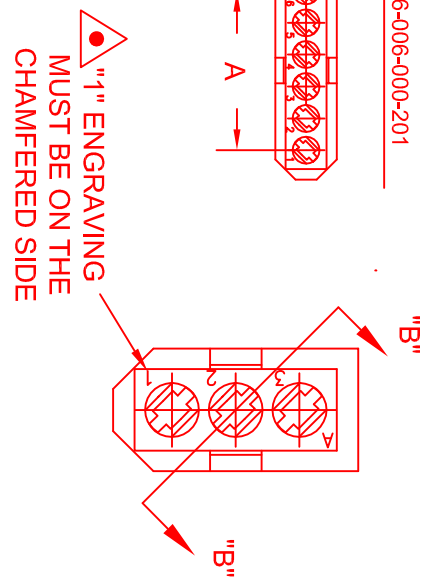
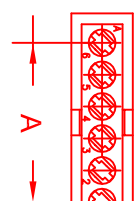
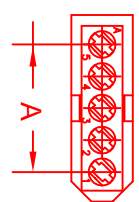
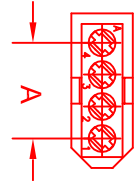
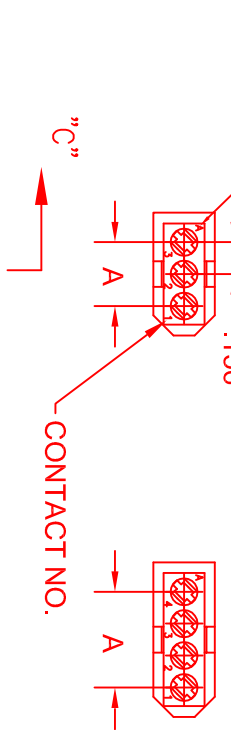

RECOMMENDED DISPOSITION OF STOCK (PRIOR ISSUE PARTS)	<input type="checkbox"/> SCRAP	<input type="checkbox"/> INSPECT
	<input type="checkbox"/> REWORK	<input type="checkbox"/> USE AS IS
	<input type="checkbox"/> SEE ENGINEERING MEMO	
ISSUE NUMBER	ORIGINAL	①

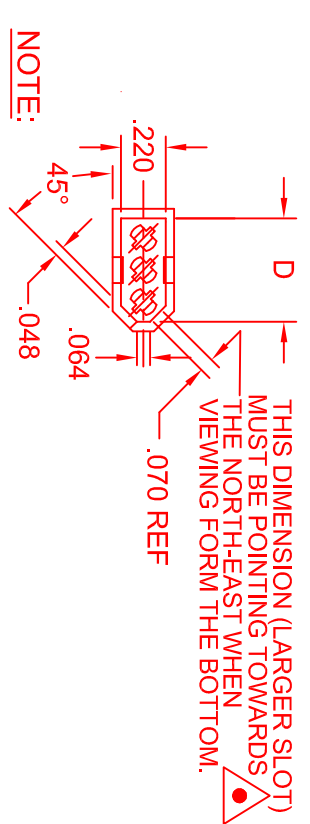
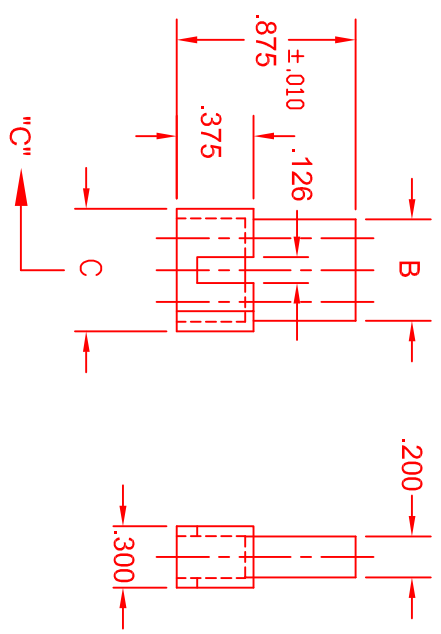

- 1) MATERIAL: NYLON 6, COLOR: NATURAL
- 2) THIS PLUG INSULATOR IS DESIGNED FOR MATING WITH RECEPTACLE P/N 556-003-000-102, 556-004-000-102, 556-005-000-102 AND 556-006-000-102
- 3) ▲ INDICATES CRITICAL NOTE OR DIMENSION.

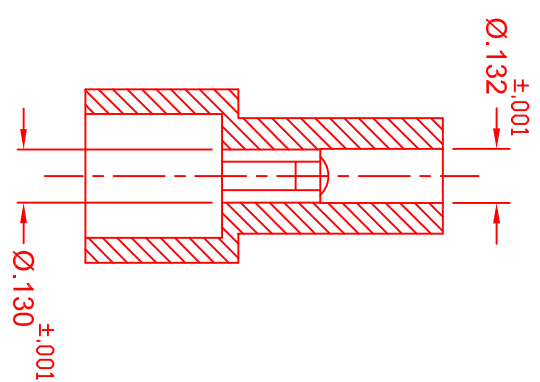

SECTION "B"-"B" SCALE 2:1

PART NUMBER	TOTAL NUMBER OF CONTACTS	"A" ±.002	"B" ±.010	"C" ±.010	"D" ±.015 -.000
556-003-000-201	3	.312	.495	.600	.505
556-004-000-201	4	.468	.651	.756	.661
556-005-000-201	5	.624	.807	.912	.817
556-006-000-201	6	.780	.963	1.068	.973

TOLERANCE UNLESS NOTED	556 SERIES PLUG INSULATOR		EDAC INC TORONTO, ONTARIO CANADA	ACAD REFERENCE NO. 55621001	DRAWN: R.STAMONICA	DATE: JULY 09,2012
DIMENSION	TOLERANCE		EDAC INC TORONTO, ONTARIO CANADA	ACAD REFERENCE NO. 55621001	CHECKED:	DATE:
.00	± ---		EDAC INC TORONTO, ONTARIO CANADA	ACAD REFERENCE NO. 55621001	CHECKED:	DATE:
.000	± .005		EDAC INC TORONTO, ONTARIO CANADA	ACAD REFERENCE NO. 55621001	CHECKED:	DATE:
.0000	± ---		EDAC INC TORONTO, ONTARIO CANADA	ACAD REFERENCE NO. 55621001	CHECKED:	DATE:
ANGULAR	+ 0°30'		EDAC INC TORONTO, ONTARIO CANADA	ACAD REFERENCE NO. 55621001	CHECKED:	DATE:

EDAC INC TORONTO, ONTARIO CANADA
 THESE DRAWINGS AND SPECIFICATIONS ARE THE PROPERTY OF EDAC INC AND SHALL BE USED AS THE BASIS FOR THE MANUFACTURE OR SALE OF APPARATUS WITHOUT WRITTEN PERMISSION.
 YOUR CONNECTION TO QUALITY & SERVICE

SALES-556-210-001
 SHEET 1 OF 2
 ISSUE 1