



Chipsmall Limited consists of a professional team with an average of over 10 year of expertise in the distribution of electronic components. Based in Hongkong, we have already established firm and mutual-benefit business relationships with customers from,Europe,America and south Asia,supplying obsolete and hard-to-find components to meet their specific needs.

With the principle of “Quality Parts,Customers Priority,Honest Operation,and Considerate Service”,our business mainly focus on the distribution of electronic components. Line cards we deal with include Microchip,ALPS,ROHM,Xilinx,Pulse,ON,Everlight and Freescale. Main products comprise IC,Modules,Potentiometer,IC Socket,Relay,Connector.Our parts cover such applications as commercial,industrial, and automotives areas.

We are looking forward to setting up business relationship with you and hope to provide you with the best service and solution. Let us make a better world for our industry!



## Contact us

Tel: +86-755-8981 8866 Fax: +86-755-8427 6832

Email & Skype: info@chipsmall.com Web: www.chipsmall.com

Address: A1208, Overseas Decoration Building, #122 Zhenhua RD., Futian, Shenzhen, China





# WATERPROOF

Registered



ISO 9001

# EDACON

*an EDACOM company*



an EDACOM company

40 Tiffield Road., Scarborough, Ontario, M1V 5B6, Canada
Telephone: (416) 754-3322 Facsimile: (416) 754-3299
e-mail: edac@edac.net Web Page: http://www.edac.net
Your Connection to Quality and Service

NUMERICAL INDEX
Series Page
556 8
566 2
566 Tools 7
568 6
568 Tools 7
570 4
570 Tools 7
TABLE OF CONTENTS
Products Page
Application Notes 1
Water Proof Connectors 5
Discrete wire Connectors 8

ENGINEERING NOTES:

The Waterproof series of connectors are made using the following materials and processes.

The insulator housing is made of high impact flame retardant (UL 94-V0) Polyester (PBT). The water seals are moulded out of silicone rubber. The housings use latching mechanisms to hold and lock the mating halves together.

The mated connectors have been tested for various levels of resistance to water ingress. These test vary from a level of "0" which means "without protection" to "8" which is a fully submersible connector.

The contacts are made of brass or phosphor bronze and are plated with nickel (to improve wear resistance and reduce galvanic corrosion), then they are plated with a tin-lead alloy for conductivity.

Crimp contacts are available for wire sizes of 28 to 22 AWG for the 566 series, and for 22 to 16 AWG for the 568 and 570 series.

APPLICATION NOTES:

The typical application of these connectors includes any place where there is the chance of water contaminating the circuit. These applications have included: bathrooms, hot water heaters, washing machines, water purifiers, outdoor motors, frozen food show cases, dishwashers and most outdoor applications.

The Waterproof connectors have been approved for use in environments which require a protection grade of "4" (Splash-Proof). The connectors have successfully passed testing to a protection grade of "7".

The following chart describes the protection grades, class descriptions, and meanings of the various moisture/water protection grades.

Table with 3 columns: Protection Grade, Class Description, Meaning. Rows include grades 0 through 8 with their respective descriptions and meanings.

Waterproof Standard descriptions Based on JIS C 0920-1993

The waterproof connectors are available in a wire-to-wire or a wire-to-board configuration. When used in a wire-to-board application, a silastic conformal coating may be used to seal the board mounted connector.

# 566 SERIES WATERPROOF CONNECTOR

Plug, Receptacle & Board Mount

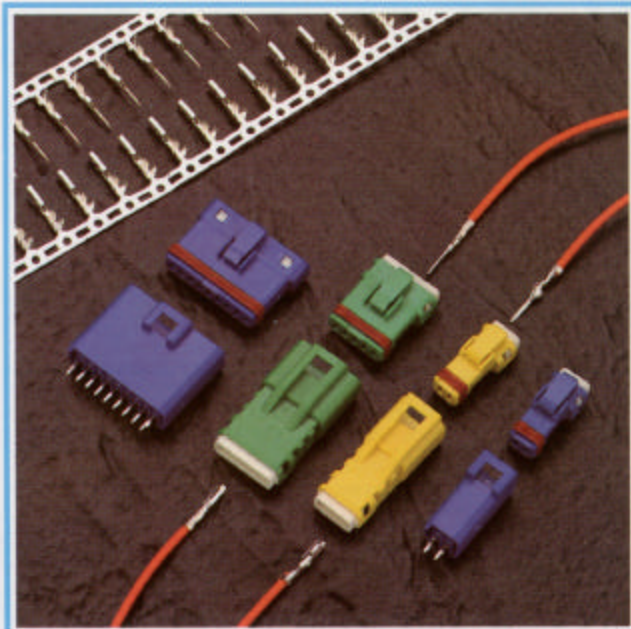

## FEATURES

- Fully waterproof connector
- Plastic latch provides locking mechanism
- Plug and Receptacle in 1, 3, and 5 Contact positions
- Board mount style available in 2, 3, 5 and 9 contact positions
- Tools Available for Contact Installation, Removal and Crimping
- Able to carry current up to 2 A

## SPECIFICATIONS

- Insulator Material: PBT (UL94V-0)
- Contact Material: PB / Tin plating
- Wire Housing Seal: Silicone Rubber
- Current Rating: 2 Amperes maximum
- Contact Resistance: 10m  $\Omega$  Maximum
- Insulator Withstanding Voltage: 1000 V AC rms at Sea Level
- Insulation Resistance: 1000M  $\Omega$  Minimum at 500 VDC
- Operating Temperature: -40 to +105 Degrees C
- Rated Voltage: 250 V
- Waterproof Grade 4
- Insulation diameter from .039" (1.0mm) to .059" (1.5mm) can be accommodated using different wire seals.

## 566 SERIES ORDERING CODE

Example Part Number **566 - 003 - 000 - 1 1 0**

Series \_\_\_\_\_  
 Total Number of Contacts \_\_\_\_\_  
 Contact Code \_\_\_\_\_  
 Style \_\_\_\_\_  
 Wire Diameter \_\_\_\_\_  
 Termination \_\_\_\_\_

Series 566

Total Number of Contacts 002, 003, 005 or 009

### Contact Code <sup>1,2</sup>

000 No Contacts Assembled  
 420 Board Mount Contacts Installed

### Style <sup>3</sup>

1 Plug  
 2 Receptacle

### Wire Diameter <sup>4</sup>

1 AWG 28 to 26  
 Insulation Dia. .039" (1.0 mm) to .049" (1.25 mm)  
 2 AWG 24 to 22  
 Insulation Dia. .049" (1.25 mm) to .059" (1.5 mm)

### Termination

0 Wire crimp terminals required  
 1 PC Board Mount

### Ordering Code Notes

1) Crimp contacts are available for the 566 series connectors. Contacts may be ordered separately for pre-wired or select position assembly.

Part Number	Description
566-290-711	Male contact
566-290-721	Female contact

2) For contact installation, removal and crimping tools, refer to page 7.

3) Insulator design prevents improper mating of individual plug and receptacle.

# 566 SERIES WATERPROOF CONNECTOR

Plug, Receptacle & Board Mount

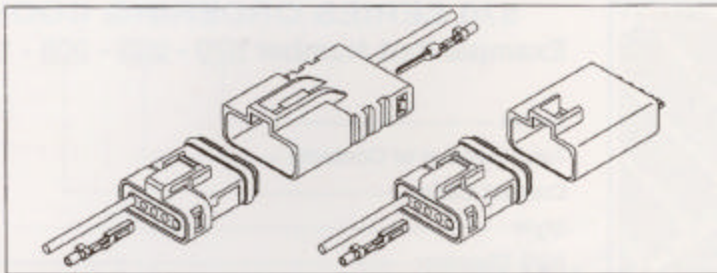

566-002-000-210 (SML GA)  
566-002-000-220 (LRG GA)

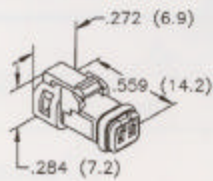

566-002-000-110 (SML GA)  
566-002-000-120 (LRG GA)

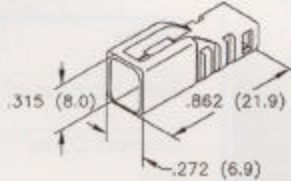

566-002-420-101

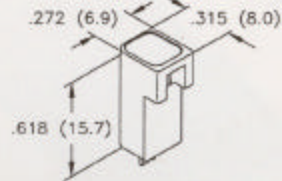

566-003-000-210 (SML GA)  
566-003-000-220 (LRG GA)

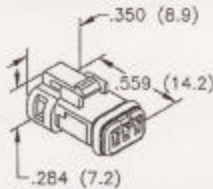

566-003-000-110 (SML GA)  
566-003-000-120 (LRG GA)

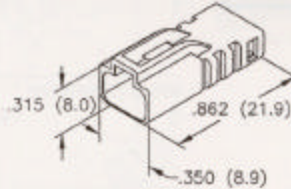

566-003-420-101

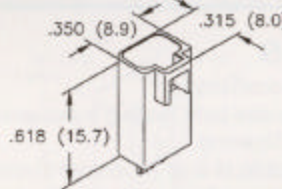

566-005-000-210 (SML GA)  
566-005-000-220 (LRG GA)

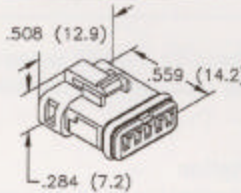

566-005-000-110 (SML GA)  
566-005-000-120 (LRG GA)

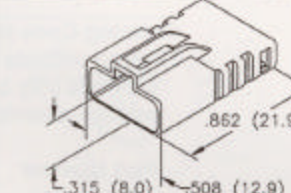

566-005-420-101

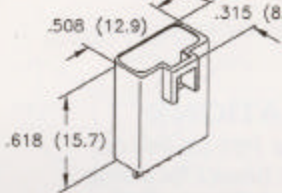

566-009-000-210 (SML GA)  
566-009-000-220 (LRG GA)

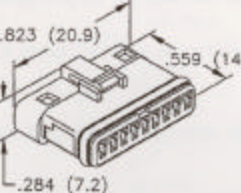

### ASSEMBLY LAYOUT

- ① RETAINER
- ② WIRE SEAL
- ③ F TERMINAL
- ④ 566-NNN-000-210/220
- ⑤ HOUSING SEAL
- ⑥ M TERMINAL
- ⑦ 566-NNN-000-110/120
- ⑧ 566-NNN-000-101

566-009-420-101

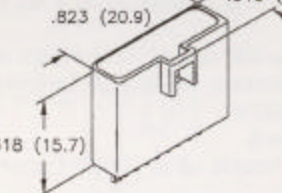

F TERMINAL      M TERMINAL

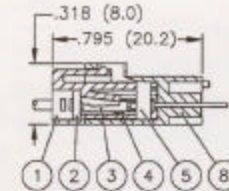
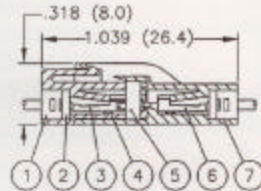
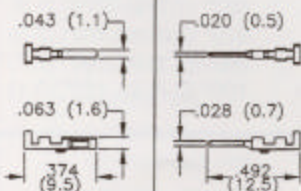

# 570 SERIES WATERPROOF CONNECTOR

Plug, Receptacle & Board Mount

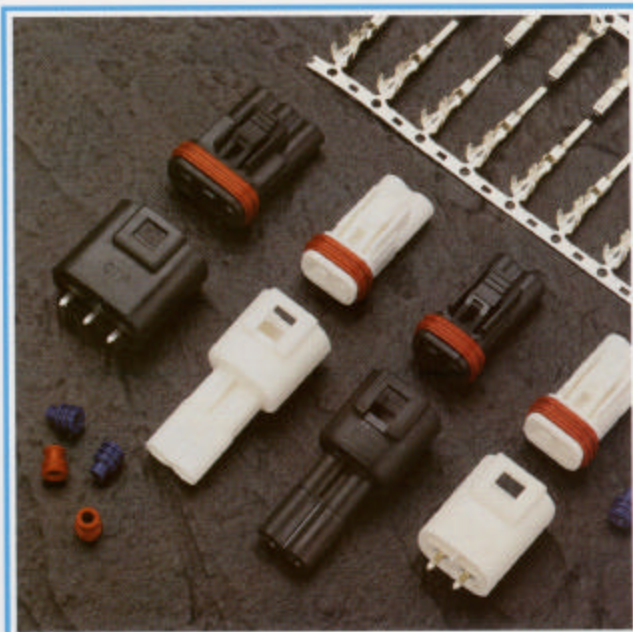

## FEATURES

- Fully waterproof connector
- Plastic latch provides both locking mechanism and polarity
- 5.8 mm Contact Spacing
- Plug and Receptacle in 2 or 3 Contact positions
- Board Mount Style available in 1, 2 or 3 contact positions
- Contact Termination Options include Crimp and P.C. Tail
- Tools Available for Contact Installation, Removal and Crimping
- Able to carry large current up to 10 A

## SPECIFICATIONS

- Insulator Material: PBT (UL94V-0)
- Contact Material: Brass / Tin plating
- Wire Housing Seal: Silicone Rubber
- Current Rating: 10 Amperes maximum
- Contact Resistance: 10m  $\Omega$  Maximum
- Insulator Withstanding Voltage: 1700 V AC rms at Sea Level
- Insulation Resistance: 1000M  $\Omega$  Minimum at 500 VDC
- Operating Temperature: -40 to +105 Degrees C
- Rated Voltage: 300 V
- Waterproof Grade 4
- For use with PC boards up to (.063") 1.6mm

## 570 SERIES ORDERING CODE

Example Part Number **570 - 003 - 000 - 1 0 0**

Series \_\_\_\_\_  
 Total Number of Contacts \_\_\_\_\_  
 Contact Code \_\_\_\_\_  
 Style \_\_\_\_\_  
 Wire Diameter \_\_\_\_\_  
 Termination \_\_\_\_\_

Series 570

Total Number of Contacts 001, 002 or 003

Contact Code <sup>1,2</sup>  
 000 No Contacts Assembled  
 420 Board Mount Contacts Installed

Style <sup>3</sup>  
 1 Plug  
 2 Receptacle

Wire Diameter <sup>4</sup>  
 0 None installed; both contacts and water seals sold separately

Termination  
 0 Wire crimp terminals required  
 1 PC Board Mount

### Ordering Code Notes

1) Crimp contacts are available for the 570 series connectors. Contacts may be ordered separately for pre-wired or select position assembly.

Part Number	Description
570-290-711	Male contact for smaller gauge wire
570-290-721	Female contact for smaller gauge wire
570-290-731	Male contact for larger gauge wire
570-290-741	Female contact for larger gauge wire

2) For contact installation, removal and crimping tools, refer to page 7.

3) Insulator design prevents improper mating of individual plug and receptacle.

4) Wire Seals are available as follows:

Part Number	Colour	Insulation Dia	Flange
570-260-001	Black	.067" (1.7) to .075" (1.9)	No
570-260-002	Blue	.079" (2.0) to .102" (2.6)	No
570-260-003	Blue	.083" (2.1) to .106" (2.7)	Yes
570-260-004	Brown	.106" (2.7) to .122" (3.1)	Yes

# 570 SERIES WATERPROOF CONNECTOR

Plug, Receptacle & Board Mount

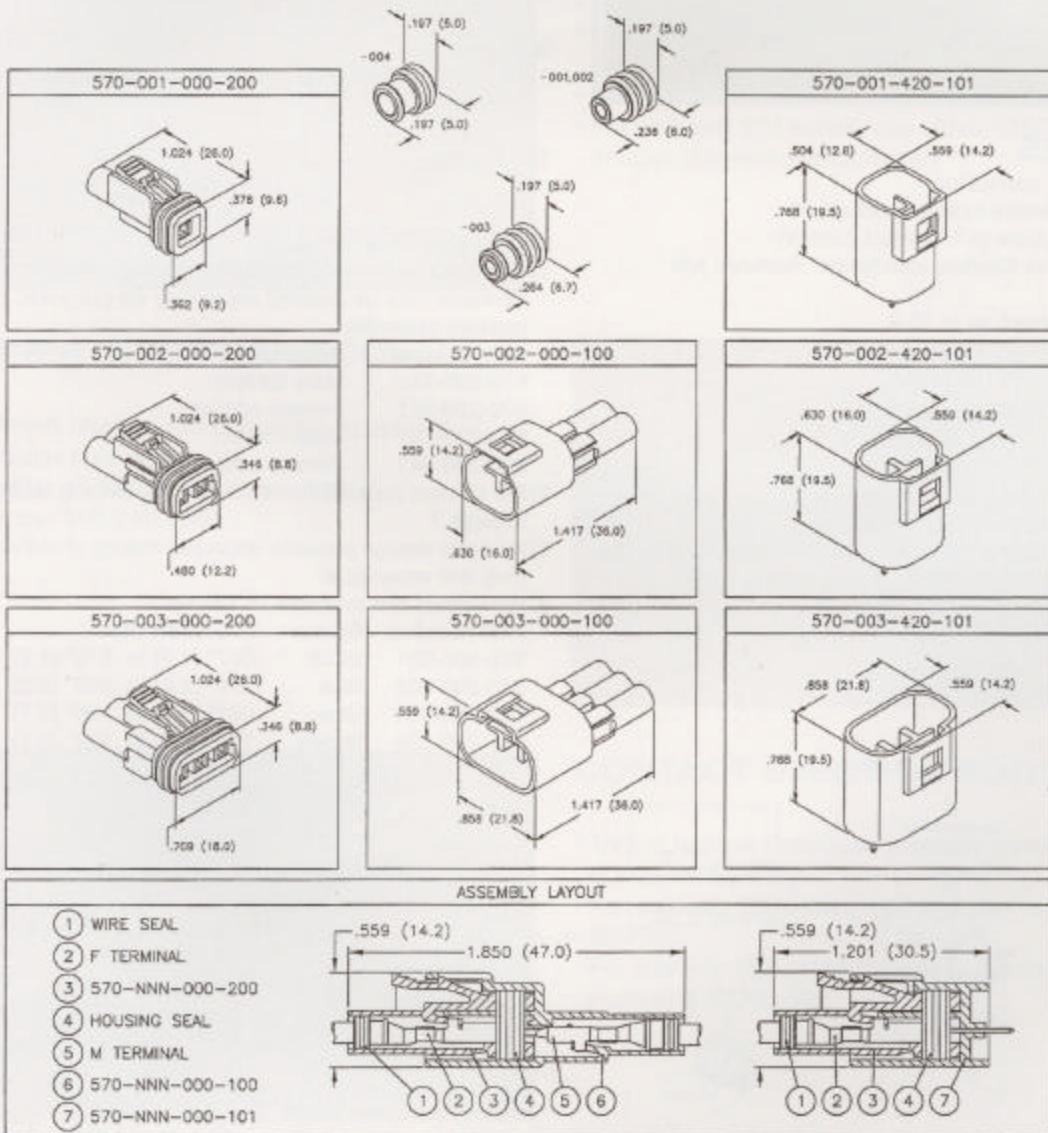
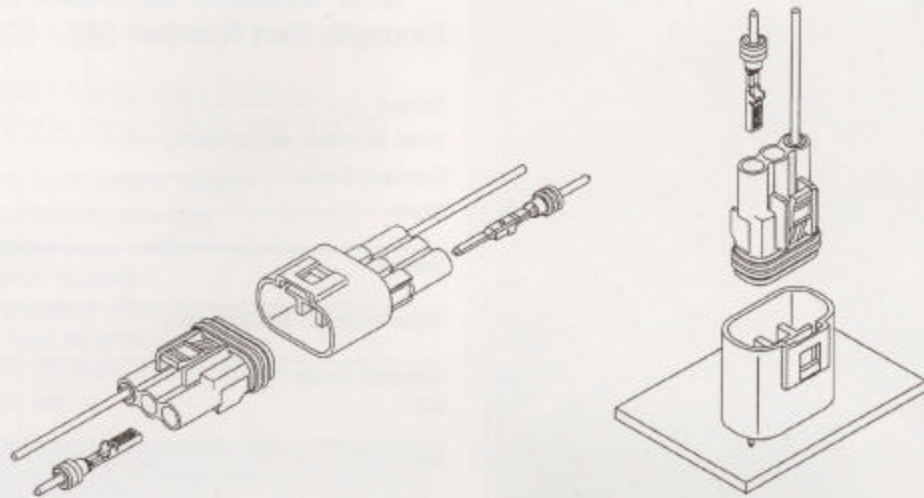

# 568 SERIES WATERPROOF CONNECTOR

## Plug and Receptacle

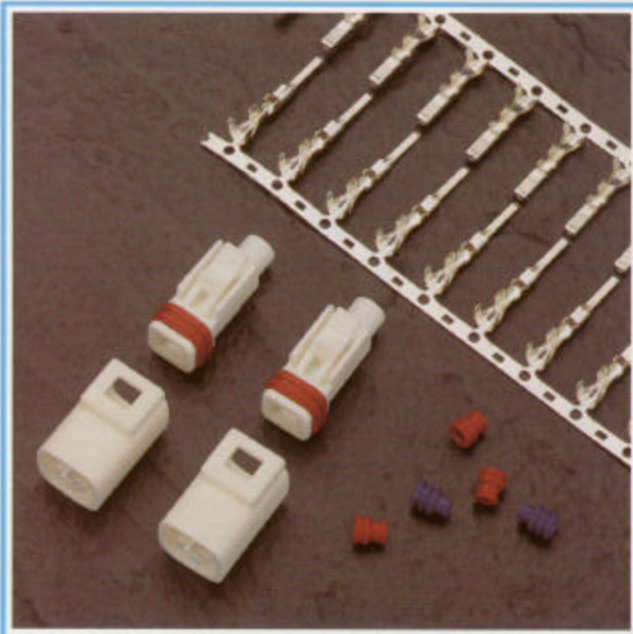

### FEATURES

- Fully waterproof connector
- Plastic latch provides locking mechanism
- Plug and Receptacle in 1 Contact position
- Tools Available for Contact Installation, Removal and Crimping
- Able to carry current up to 15 A

### SPECIFICATIONS

- Insulator Material: PBT (UL94V-0)
- Contact Material: Brass / Tin plating
- Wire Housing Seal: Silicone Rubber
- Current Rating: 15 Amperes maximum
- Contact Resistance: 10m  $\Omega$  Maximum
- Insulator Withstanding Voltage: 1700 V AC rms at Sea Level
- Insulation Resistance: 1000M  $\Omega$  Minimum at 500 VDC
- Operating Temperature: -40 to +105 Degrees C
- Rated Voltage: 300 V
- Waterproof Grade 4

### 568 SERIES ORDERING CODE

Example Part Number **568 - 001 - 000 - 100**

Series \_\_\_\_\_  
 Total Number of Contacts \_\_\_\_\_  
 Contact Code \_\_\_\_\_  
 Style \_\_\_\_\_

Series	568
Total Number of Contacts	001
Contact Code <sup>1,2</sup>	No Contacts Assembled
Style <sup>3</sup>	Plug Receptacle
Wire Diameter <sup>4</sup>	None installed; both contacts and water seals sold separately

Termination  
 0 Wire crimp terminals required

#### Ordering Code Notes

1) Crimp contacts are available for the 568 series connectors. Contacts may be ordered separately for pre-wired or select position assembly.

Part Number	Description
570-290-711	Male contact
570-290-721	Female contact
570-290-731	Male contact
570-290-741	Female contact

2) For contact installation, removal and crimping tools, refer to page 7.

3) Insulator design prevents improper mating of individual plug and receptacle.

4) Wire Seals are available as follows:

Part Number	Colour	Insulation Dia	Flange
570-260-001	Black	.067" (1.7) to .075" (1.9)	No
570-260-002	Blue	.079" (2.0) to .102" (2.6)	No
570-260-003	Blue	.083" (2.1) to .106" (2.7)	Yes
570-260-004	Brown	.106" (2.7) to .122" (3.1)	Yes

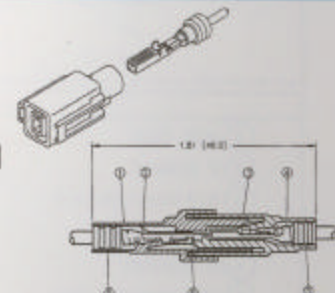
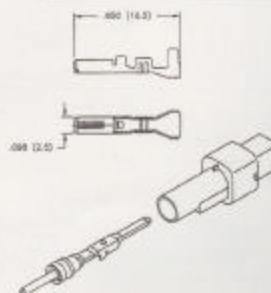
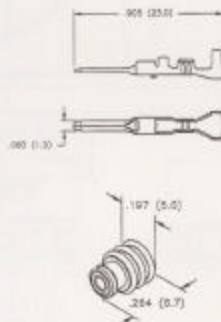
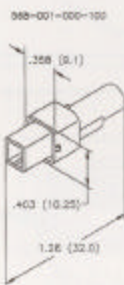
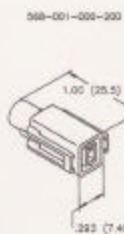

① 568-001-000-100 ② U TERMINAL ③ 568-001-000-100  
 ④ F TERMINAL ⑤ WIRE SEAL ⑥ HOUSING SEAL



# Tools for 566, 568, 570 Series Waterproof Connectors

Crimp Tools, Withdrawal Tool, Automated Crimping Tool

## AUTOMATIC CONTACT CRIMP MACHINE

- Part Number 516-280-700 for base machine
- Applicators available to crimp all 566, 568 and 570 series contacts
- All required guards for operator safety
- Easy access for all setting changes
- Foot switch to initiate crimp cycle
- Mounts to any bench surface
- Quick change applicators allow for fast conversions from one contact type to another
- Requires 110V 50 / 60 Hz electrical supply



## CONTACT HAND CRIMP TOOL

- Manual hand crimp tool
- Uses contacts on carrier strip, crimps them and cuts the contacts from the carrier
- For 566 series, use crimper number 566-280-200
- For 568 and 570 series, use either 570-280-200 for smaller diameter wire and part

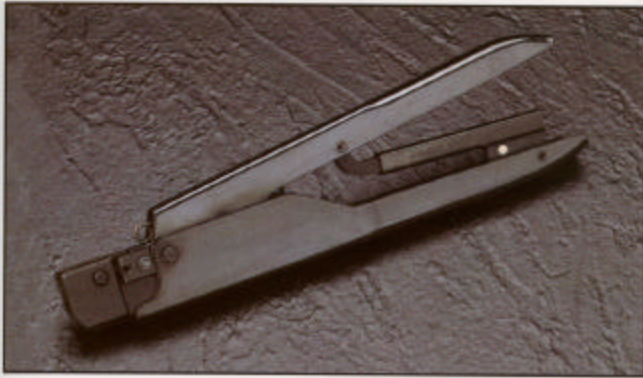

## RETAINER INSERTION TOOL

- Tool to insert retainer into connector housing to ensure water tight seal
- Required for all 566 series connectors
- Part number 566-280-250



## CONTACT EJECTION TOOL

- Tool to remove previously inserted contact from connector housing
- For use with 566 series, use tool part number 566-280-300
- For use with 568 and 570 series, use tool part number 570-280-300

# 556 SERIES EDACON CONNECTOR

## Plug and Receptacle

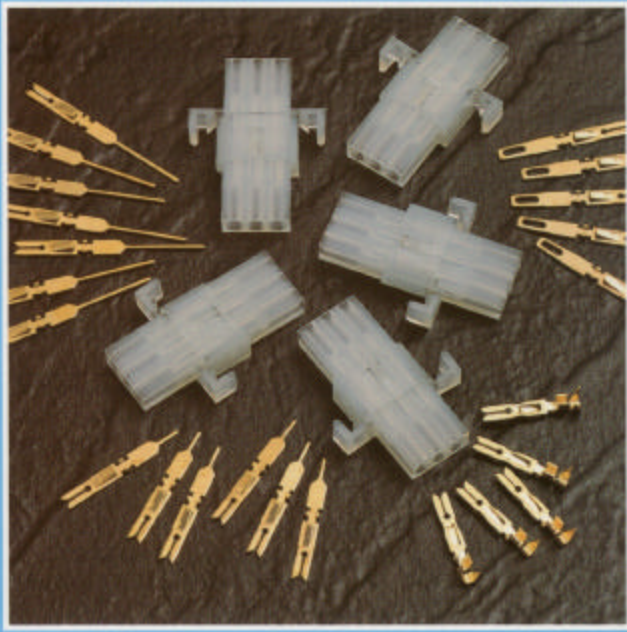

### FEATURES

- UL Recognized
- .156 (3.96) Contact Spacing
- Plug and Receptacle in 3, 4, or 6 Contact Sizes
- Edacon Hermaphroditic Contact Mating Design
- Contact Termination Options include Crimp, P.C. Tail, Wire Hole, Wire Wrap and Taper Tail
- Tools Available for Contact Installation, Removal and Crimping
- These connectors are not waterproof.

### SPECIFICATIONS

- Insulator Material: White Nylon
- Contact Material: Phosphor Bronze Alloy CA-510
- Contact Plating: Gold over Nickel for Entire Contact
- Current Rating: 8.5 Amperes
- Contact Resistance: 10 Milliohms Maximum
- Dielectric Withstanding Voltage: 2000 V AC rms at Sea Level
- Insulation Resistance: 5000 Megohms Minimum
- Operating Temperature: -65 to +125 Degrees C
- Insertion and Withdrawal Force: 2 to 16 oz (0.56 to 4.45 N) per Contact Position

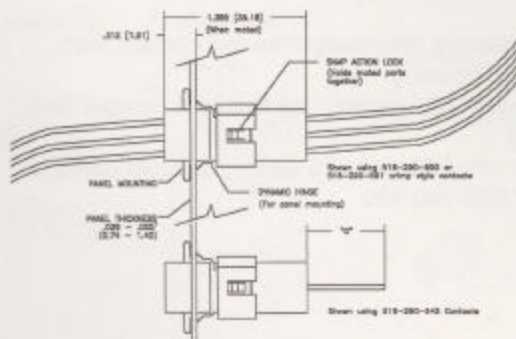

### 556 SERIES ORDERING CODE

Example Part Number **556 - 003 - 500 - 102**

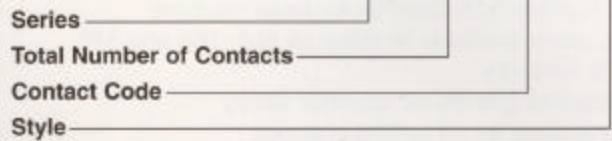

Series	556
Total Number of Contacts	003, 004 or 006

Contact Code <sup>1,2</sup>	Description & Tail Size	Tail Length "G"
000	No Contacts Assembled	-- --
500	Wire Hole .110 x .024 (2.79 x 0.61)	.245 (6.22)
501	Taper Tail	.245 (6.22)
520	P.C. Tail .025 x .024 (0.64 x 0.61)	.215 (5.46)
540	Wire Wrap .050 x .024 (1.27 x 0.61)	.600 (15.24)
541	Wire Wrap .026 x .024 (0.66 x 0.61)	.620 (15.75)
542	Wire Wrap .050 x .024 (1.27 x 0.61)	.790 (20.07)

Style and Material <sup>3</sup>	Style
101	Plug
201	Receptacle with Panel Retention

### Ordering Code Notes

- 1) Crimp contacts are available for the 556 series connectors. Contacts may be ordered separately for pre-wired or select position assembly.

Part Number	Description	
516-290-500	Wire Hole	
516-290-501	Taper Tail	
516-290-520	P.C. Tail	
516-290-540	Wire Wrap	
516-290-541	Wire Wrap	
516-290-542	Wire Wrap	
516-290-590	Crimp - Loose	
516-290-591	Crimp - 1800	

- 2) For contact installation, removal and crimping tools, refer to page 112.
- 3) Insulator design prevents improper mating of individual plug and receptacle.

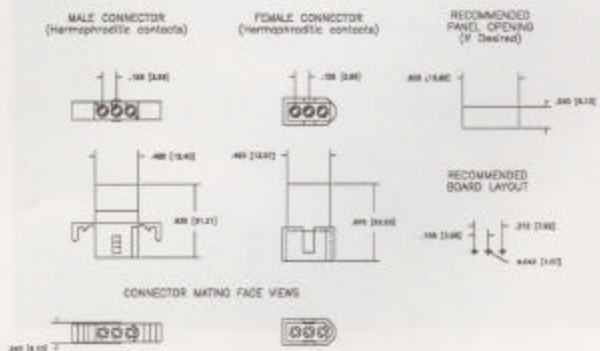

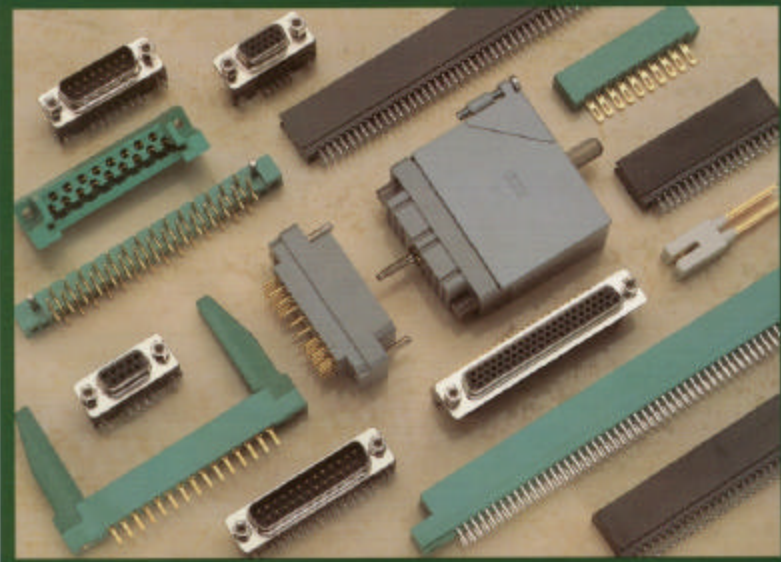

PRINTED IN CANADA 10M98A



*an EDACOM company*

**40 TIFFIELD ROAD  
SCARBOROUGH, ONTARIO, CANADA M1V 5B6**

Telephone: (416)754-3322 Facsimile: (416)754-3299  
E-mail: [edac@edac.net](mailto:edac@edac.net) Web Page: <http://www.edac.net>