



Chipsmall Limited consists of a professional team with an average of over 10 year of expertise in the distribution of electronic components. Based in Hongkong, we have already established firm and mutual-benefit business relationships with customers from,Europe,America and south Asia,supplying obsolete and hard-to-find components to meet their specific needs.

With the principle of "Quality Parts,Customers Priority,Honest Operation,and Considerate Service",our business mainly focus on the distribution of electronic components. Line cards we deal with include Microchip,ALPS,ROHM,Xilinx,Pulse,ON,Everlight and Freescale. Main products comprise IC,Modules,Potentiometer,IC Socket,Relay,Connector.Our parts cover such applications as commercial,industrial, and automotives areas.

We are looking forward to setting up business relationship with you and hope to provide you with the best service and solution. Let us make a better world for our industry!



Contact us

Tel: +86-755-8981 8866 Fax: +86-755-8427 6832

Email & Skype: info@chipsmall.com Web: www.chipsmall.com

Address: A1208, Overseas Decoration Building, #122 Zhenhua RD., Futian, Shenzhen, China





Expertise Applied | Answers Delivered

A collage of various electronic components, including sensors and connectors, arranged around a central green square. The components include cylindrical sensors, rectangular modules, and thin-wire devices.

PRODUCT
CATALOG &
DESIGN GUIDE

SENSORS

Proximity | Level | Speed | Flow



About This Guide

This guide provides an introduction to magnetic sensing and options for value-added custom design packages. It also offers practical suggestions for selecting reed switches, reed sensors and Hall effect sensors for a variety of applications.

Topic	Page
Introduction to Magnetic Sensing	2-3
Value-Added Customization	3
Reed Switches	4-5
Hall Effect Sensors	7
Reed Sensors	8-9
Reed Relays	10
Magnetic Actuators	11
Applications	12-15

WHY CHOOSE LITTELFUSE

Littelfuse, Inc. is the global leader in circuit protection solutions. Our company offers the broadest spectrum of circuit protection technologies along with products that can be used in any application that requires electrical energy.

Complementing our vast portfolio of circuit protection products is a global network of technical support and design expertise. Using our decades of design experience, we help you address unique application challenges and achieve regulatory compliance.

Your Single Source

Littelfuse offers the world's most diverse and extensive circuit protection product line. If we do not have an off-the-shelf product to meet your needs, we will work with you to develop a forward-thinking solution that precisely fits your application. Our goal is to provide the most comprehensive range of options so that you will not have to make compromises in your designs.

Testing Support

Through our network of Global Labs located in China, Germany, Japan, Mexico, Philippines and the U.S., we design innovative circuit protection solutions and provide customer application support and testing. Our unique capabilities include performance testing, material analysis and regulatory compliance testing. The dedication of our Global Labs ensures the outstanding performance, safety and reliability of our products and support services for our worldwide customer base.

Application Knowledge

At Littelfuse, our expertise involves applying reliable and efficient circuit protection solutions, innovative technologies and global resources to address circuit protection challenges in a variety of applications. We utilize a worldwide network of research teams that focus on product development and support, design-in programs and application testing in our Global Labs.

Global Support

Littelfuse products, application knowledge and technical support are available around the globe. We offer a network of regional customer support offices and hundreds of authorized distributors to assist you with your circuit protection requirements.

WHY CHOOSE LITTELFUSE SENSORS

Hamlin, now part of Littelfuse, Inc., has a long, rich history of leading the industry in providing magnetic sensing solutions. Our experts are committed to delivering the best products and solutions for your specific needs.

Our global organization provides:

- Custom sensor designs per customer specifications
- Vertically integrated manufacturing
- In-house magnetic simulation support
- Quick turnaround for custom sensor prototypes

Quality Assurance

Our global manufacturing facilities abide by strict quality assurance requirements and hold the following quality management system registrations:



BS EN ISO 14001



BS EN ISO 9001 / TS16949:2009



59135
(High-Temperature Flange Mount
Reed Sensor)



59010
(Ultra-Mini Firecracker)



MDCG-4
(Reed Switch)



59050
(Overmolded Reed Switch)



55140
(Flange Mount
Hall Effect Sensor)

Introduction to Magnetic Sensing

REED SWITCHES

A reed switch has two ferromagnetic blades (reeds) contained within a tubular glass envelope that is hermetically sealed at each end. The contacts on each reed blade have a thin layer of precious metal material deposited on them. There is usually nitrogen gas on the inside of the glass envelope to eliminate the presence of oxygen and ensure that the contacts will not oxidize. Reed switches are activated by a permanent magnet or an electromagnet. The reed switch and magnetic field combination is commonly known as the “magnetic circuit.”

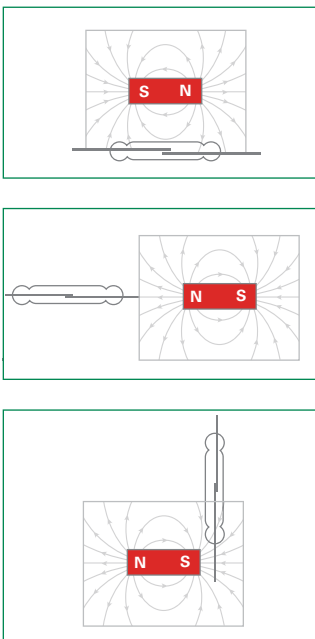

Figure 1-Magnetic field lines must be aligned parallel to a reed switch's contacts in order to open/close the contacts

The relative stiffness of the reed blades along with the small gap and overlap between the two contacts controls the sensitivity of the reed switch. The sensitivity of the switch is the amount of magnetic field that is required to actuate the contact an open or closed mode. It is measured in units of ampere-turns (AT). Most reed switches have a sensitivity range of 10–30 AT, where 10 AT is more sensitive than 30 AT.

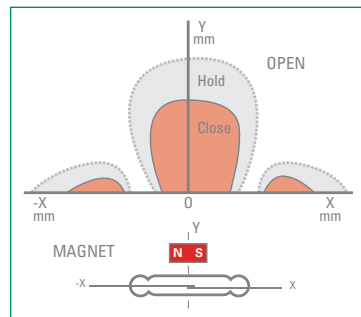

Figure 2-Two-pole linear activation, parallel orientation

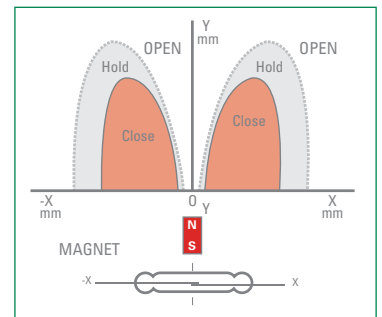

Figure 3-Single-pole linear activation, perpendicular orientation

REED SENSORS

Reed sensors are reed switches that are packaged within an external housing for simplified mounting/connecting and additional protection against environmental influences. These sensors are typically mounted in mechanical systems. A bare reed switch can easily be mounted on circuit boards. However, for an application such as a door security sensor, the reed switch needs a protective shell/housing for handling and mounting. These packages offer resistance to mechanical stress by protecting the bare glass of the reed switch.

REED RELAYS

A reed relay is made by combining a reed switch with a copper coil. Like other relays, this provides galvanic isolation between the coil input and the controlled contact(s). However, because of the small size and magnetic efficiency of the reed switch, the power required to drive the coil is lower than most other types of relays. Other advantages include high insulation resistance, low contact resistance and long contact life. Reed relays are used in many applications, including automotive, test equipment, security, medical and process control equipment.

Comparing Reed vs. Hall Effect

Although there are differences between reed switch and Hall effect technologies, both platforms offer practical advantages for various applications. Here is a comparison of the benefits of each technology.

Reed Switch		Hall Effect Sensor
•	Noncontact sensing element	•
•	Zero power consumption	
•	High-Frequency operation	•
•	Digital switching	•
	Linear sensing	•
	Integrated circuitry	•
	Ultra-small package size	•
•	Electrical load capability	
•	EMC/ESD immunity	

HALL EFFECT SENSORS

A Hall effect device is a semiconductor-based integrated circuit with Hall plates that respond to magnetic fields. Additional circuitry is added for power supply and signal conditioning, temperature compensation and EMC/ESD protection. Hall effect devices provide digital or analog output signals that are used for proximity and continuous rotary or linear positioning. Unlike a reed switch, a Hall effect device contains active circuitry, so it draws a small amount of current at all times. Hall effect devices come in two- or three-wire versions. Some devices are programmable.

MAGNETIC ACTUATORS

Littelfuse offers a wide range of magnetic actuators that are packaged in shapes similar to the relative mating sensors. We also offer a limited family of bare magnets with various grades of materials, including ferrite (ceramic), AlNiCo and neodymium iron boron (NdFeB) materials.



Value-Added Customization

Littelfuse specializes in custom design packages that meet our customers' needs for both reed and Hall effect sensor designs. Several of our vertically integrated processes are listed below.

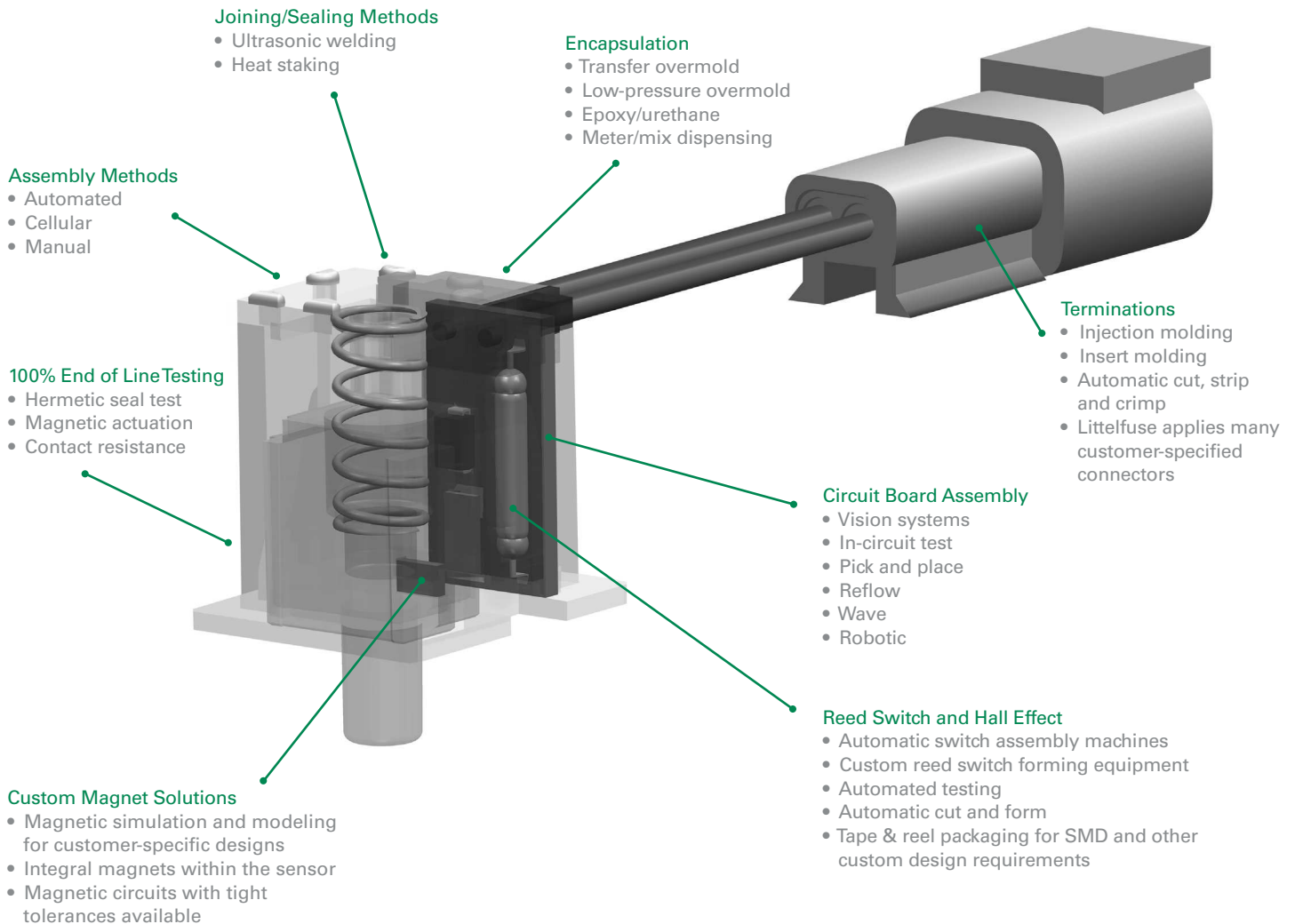

Reed Switches



Power	Size	Terminals	Switch Type	Package	P/N	Body Length (mm)/(Inch)	Total Length (mm)/(Inch)	
Low Power	Small	Leads	A: SPST-NO	Glass	MITI-7	7.00 [.276]	40.38 [1.590]	
			A: SPST-NO	Glass	MDSR-10	10.16 [.400]	40.38 [1.590]	
			A: SPST-NO	Glass	MDSR-7	12.70 [.500]	40.38 [1.590]	
		SMD	A: SPST-NO	Glass	MISM-7	7.00 [.276]	13.72 [.540]	
			A: SPST-NO	Glass	MDSM-10	10.16 [.400]	15.62 [.615]	
			A: SPST-NO	Glass	FLEX-14	14.00 [.551]	44.30 [1.744]	
	Medium	Leads	A: SPST-NO	Glass	MDCG-4	15.24 [.600]	40.38 [1.590]	
			A: SPST-NO	Glass	MACD-14	14.00 [.551]	44.30 [1.744]	
			C: SPDT-CO	Glass	MDRR-DT	14.73 [.580]	51.66 [2.034]	
			A: SPST-NO	Glass	MDSM-4	15.24 [.600]	19.30 [.760]	
		SMD	A: SPST-NO	Glass	MASM-14	14.00 [.551]	44.30 [1.744]	
			C: SPDT-CO	Glass	MDSM-DT	14.73 [.580]	25.40 [1.00]	
			Both Leads and SMD	A: SPST-NO	Overmolded	59165	16.00 [.630]	20.20 [.795]
				A: SPST-NO	Overmolded	59166	16.00 [.630]	19.51 [.768]
		A: SPST-NO		Overmolded	59170	11.43 [.450]	16.25 [.640]	
		Leads		A: SPST-NO	Overmolded	59045-1	17.78 [.700]	15.24 [.600]
			A: SPST-NO	Overmolded	59050-1	22.86 [.900]	20.32 [.800]	
			High Power	Medium	Leads	A: SPST-NO	Glass	HA15-2
A: SPST-NO	Glass					MLRR-4	15.24 [.600]	40.38 [1.590]
A: SPST-NO	Glass	MLRR-3				15.24 [.600]	56.64 [2.230]	
A: SPST-NO	Glass	MARR-5				19.69 [.775]	56.77 [2.235]	
SMD	A: SPST-NO	Glass			MLSM-4	15.24 [.600]	19.56 [.770]	
	A: SPST-NO	Glass			MLSM-3	15.24 [.600]	19.56 [.770]	
	Leads	A: SPST-NO			Overmolded	59050-2	22.86 [.900]	20.32 [.800]
		Large			Leads	A: SPST-NO	Glass	MRPR-3
A: SPST-NO				Glass		MRPR-8	20.32 [.800]	56.64 [2.230]
A: SPST-NO				Glass		DRR-129	50.80 [2.000]	82.55 [3.250]
C: SPDT-CO	Glass			DRR-DTH		39.67 [1.562]	85.73 [3.375]	
C: SPDT-CO	Glass			DRT-DTH	39.67 [1.562]	85.73 [3.375]		

Notes:

For details on electrical specifications, visit hamlin.com
A:SPST-NO - Single Pole Single Throw - Normally Open
C:SPDT-CO - Single Pole Double Throw - Changeover

Switching Power (W)	Switching Voltage (V)	Switching Current (A)	Contact Resistance (Ω)	Operating Temperature ($^{\circ}\text{C}$)	Magnetic Sensitivity (AT)	Certification	RoHS Compliance
10	170 Vdc, 120 Vac	0.25 Adc, 0.18 Aac	0.15	-40 to +125	6-20		RoHS
10	200 Vdc, 140 Vac	0.5 Adc, 0.35 Aac	0.12	-40 to +125	10-25		RoHS
10	200 Vdc, 140 Vac	0.5 Adc, 0.35 Aac	0.1	-40 to +125	10-25		RoHS
10	170 Vdc, 120 Vac	0.25 Adc, 0.18 Aac	0.15	-40 to +125	6-20		RoHS
10	200 Vdc, 140 Vac	0.5 Adc, 0.35 Aac	0.12	-40 to +125	10-25		RoHS
10	200 Vdc, 140 Vac	0.5 Adc, 0.35 Aac	0.1	-40 to +125	10-30		RoHS
10	200 Vdc, 140 Vac	0.5 Adc, 0.35 Aac	0.1	-40 to +125	12-38		RoHS
10	200 Vdc, 140 Vac	0.5 Adc, 0.35 Aac	0.1	-40 to +125	10-30		RoHS
5	175 Vdc, 120 Vac	0.25 Adc, 0.18 Aac	0.1	-40 to +125	15-30		RoHS
10	200 Vdc, 140 Vac	0.5 Adc, 0.35 Aac	0.1	-40 to +125	12-38		RoHS
10	200 Vdc, 140 Vac	0.5 Adc, 0.35 Aac	0.1	-40 to +125	10-30		RoHS
5	175 Vdc, 120 Vac	0.25 Adc, 0.18 Aac	0.1	-40 to +125	15-30		RoHS
10	200 Vdc, 140 Vac	0.5 Adc, 0.35 Aac	0.1	-40 to +125	10-25		RoHS
10	200 Vdc, 140 Vac	0.5 Adc, 0.35 Aac	0.1	-40 to +125	10-26		RoHS
10	200 Vdc, 140 Vac	0.5 Adc, 0.35 Aac	0.15	-40 to +125	10-25		RoHS
10	200 Vdc, 140 Vac	0.5 Adc, 0.35 Aac	0.2	-40 to +105	15-30		RoHS
10	200 Vdc, 140 Vac	0.5 Adc, 0.35 Aac	0.2	-40 to +105	12-33		RoHS
20	200 Vdc, 265 Vac	0.5 Adc, 0.35 Aac	0.1	-20 to +125	17-38		RoHS
20	200 Vdc, 140 Vac	1.0 Adc, 0.7 Aac	0.1	-40 to +125	17-38		RoHS
20	200 Vdc, 140 Vac	1.0 Adc, 0.7 Aac	0.1	-40 to +125	17-38		RoHS
10	1000 Vdc, 700 Vac	0.5 Adc, 0.35 Aac	0.1	-75 to +125	17-38		RoHS
20	200 Vdc, 140 Vac	1.0 Adc, 0.7 Aac	0.1	-40 to +125	17-38		RoHS
20	200 Vdc, 140 Vac	1.0 Adc, 0.7 Aac	0.1	-40 to +125	17-38		RoHS
20	200 Vdc, 265 Vac	0.5 Adc, 0.35 Aac	0.2	-20 to +105	17-33		RoHS
50	200 Vdc, 140 Vac	1.5 Adc, 1.1 Aac	0.1	-40 to +125	22-43		RoHS
50	250 Vdc, 265 Vac	1.0 Adc, 0.7 Aac	0.1	-20 to +125	22-43		RoHS
100	400 Vdc, 280 Vac	3.0 Adc, 2.1 Aac	0.1	-40 to +125	42-83		RoHS
30	500 Vdc, 350 Vac	0.5 Adc, 0.35 Aac	0.125	-20 to +125	50-80		RoHS
50	500 Vdc, 350 Vac	1.5 Adc, 1.0 Aac	0.5	-20 to +125	50-80		RoHS



Lead Modifications

Littelfuse can cut and/or form the reed switch leads to meet your dimensional requirements. Most lead modifications can be done by Littelfuse without any additional tooling costs.



Sensors, Reed Relays and Magnetic Actuators

Our reed switch, Hall effect sensor and reed sensor products are ideally suited for various sensing applications, including proximity, level, speed and flow, as shown in the table. Customizations, including various connectors and wire lengths, are available for all our standard products. For product specifications and available options, refer to the individual product datasheets.

Sensor Type	Application			
	Proximity	Level	Speed	Flow
Reed Switches	•	•	•	•
Hall Effect Sensors				
Flat Pack	•		•	•
Round Flange Mount			•	
Flat Flange Mount	•		•	•
Threaded Barrel			•	
Vane	•		•	
Rotary/Angular			•	
Reed Sensors				
Firecracker	•	•	•	•
Threaded Barrel	•		•	•
Flange/Flat Pack	•		•	•
Float		•		
Vane	•		•	
Lever Arm	•			
Seat Occupancy	•			

Hall Effect Sensors



FLAT PACK

This sensor's rectangular package is ideally suited for mounting on a flat surface. It is designed for use in a wide range of environments.

Product Series	Description	Overall Dimensions		Operating Supply Voltage Vdc	Operating Supply Current mA	Output Type	Output High	Output Low Max.	Temperature Rating °C	
		mm (inch)							Operating	Storage
		L x W x H								
55140	Flange Mount Hall, 2-Wire	23.00 (0.906) x 14.00 (0.551) x 6.00 (0.236)		3.75 to 24	N/A	Current	N/A	2.2 - 5.6 mA	-40 to +100	-65 to +105
	Flange Mount Hall, 3-Wire	23.00 (0.906) x 14.00 (0.551) x 6.00 (0.236)		3.8 to 24	N/A	Voltage	Sinking/Open Collector	0.4 V @ 20 mA	-40 to +100	-65 to +105
	Flange Mount Hall, Analog	23.00 (0.906) x 14.00 (0.551) x 6.00 (0.236)		4.5 to 5.5	N/A	Analog Voltage	4.65 V	0.35 V	-40 to +100	-65 to +105
55300	Flat Pack Rotary Hall	28.50 (1.122) x 20.40 (0.803) x 6.35 (0.250)		4.5 to 5.5	16	Analog Voltage or PWM	4.5 V	0.5 V	-40 to +105	-65 to +105
55310	Flat Pack Digital Hall	28.50 (1.122) x 20.40 (0.803) x 6.35 (0.250)		4.75 to 24	6	Current	N/A	20 mA	-40 to +105	-65 to +105
55320	Flat Pack Linear Hall	28.50 (1.122) x 20.40 (0.803) x 6.35 (0.250)		4.5 to 5.5	16	Analog Voltage or PWM	N/A	-8 to +8 mA 0.5 to 4.5 V	-40 to +105	-65 to +125



ROUND FLANGE MOUNT

Its cylindrical package has a flat flange to accommodate mounting on a flat surface. This sensor is ideally suited for sensing a rotating ferrous metal target.

Product Series	Description	Overall Dimensions		Operating Supply Voltage Vdc	Operating Supply Current mA	Output Type	Output High	Output Low Max.	Temperature Rating °C	
		mm (inch)							Operating	Storage
		L x W x H								
55505	Flange Mount Geartooth Hall	17.86 (0.703) x 36.75 (1.447) x 41.40 (0.551)		4.75 to 24	N/A	Digital	Vdd-2	0.6 V @ 20 mA	-40 to +125	-65 to +125



FLAT FLANGE MOUNT

The low-profile, rectangular package is designed for installation in small-gap spaces.

Product Series	Description	Overall Dimensions		Operating Supply Voltage Vdc	Operating Supply Current mA	Output Type	Output High	Output Low Max.	Temperature Rating °C	
		mm (inch)							Operating	Storage
		L x W x H								
55100	Miniature Flange Mount Hall, 2-Wire	25.50 (1.004) x 11.00 (0.433) x 3.00 (0.118)		3.75 to 24	N/A	Current	N/A	N/A	-40 to +100	-65 to +105
	Miniature Flange Mount Hall, 3-Wire	25.50 (1.004) x 11.00 (0.433) x 3.00 (0.118)		3.8 to 24	N/A	Voltage	Sinking/Open Collector	0.4 V @ 10 mA	-40 to +100	-65 to +105
	Miniature Flange Mount Hall, Analog	25.50 (1.004) x 11.00 (0.433) x 3.00 (0.118)		4.5 to 5.5	N/A	Analog Voltage	4.65 V	0.35 V	-40 to +100	-65 to +105
55110	LED Flange Mount Hall	34.00 (1.399) x 14.00 (0.551) x 10.00 (0.394)		3.8 to 24	N/A	Voltage	Vdd-2 @ 0.1 mA	0.4 V @ 20 mA	-40 to +85	-65 to +85



VANE

This sensor is packaged with a magnet and a Hall effect sensing element. It is typically used in applications with a moving ferrous metal part.

Product Series	Description	Overall Dimensions		Operating Supply Voltage Vdc	Operating Supply Current mA	Output Type	Output High	Output Low Max.	Temperature Rating °C	
		mm (inch)							Operating	Storage
		L x W x H								
55085	Miniature Vane, PCB Mount, Hall	28.00 (1.102) x 13.50 (0.531) x 9.00 (0.354)		3.8 to 24	N/A	Voltage	Sinking/Open Collector	0.4 V @ 20 mA	-40 to +100	-65 to +105



THREADED BARREL

Designed for harsh environments, this sensor may easily be mounted and adjusted using the supplied retaining nuts. Its cylindrical package is available with metric threads.

Product Series	Description	Overall Dimensions		Operating Supply Voltage Vdc	Operating Supply Current mA	Output Type	Output High	Output Low Max.	Temperature Rating °C	
		mm (inch)							Operating	Storage
		Thread Pitch x L								
55075	Stainless Steel M12 Geartooth Hall	M12 x 1 Pitch x 46.00 (1.811)		4.75 to 25.2	N/A	Digital	Vdd - 2	0.6 V @ 20 mA	-40 to +85	-65 to +85



ROTARY/ANGULAR

This sensor is packaged with a magnet and a Hall effect sensing element. It provides instantaneous angular position measurement.

Product Series	Description	Overall Dimensions		Operating Supply Voltage Vdc	Operating Supply Current mA	Output Type	Output High	Output Low Max.	Temperature Rating °C	
		mm (inch)							Operating	Storage
		L x W x H								
55250	Rotary Hall	50.00 (1.968) x 37.30 (1.469) x 28.25 (1.112)		4.5 to 5.5	16	Analog Voltage or PWM	4.5 V	0.5 V	-40 to +125	-65 to +125

Reed Sensors



FIRECRACKER

This sensor offers a slim, cylindrical package that is suitable for mounting on a frame.

Product Series	Description	Overall Dimensions	Contact Rating	Switching Voltage	Breakdown Voltage	Switching Current	Contact Resistance, Initial	Mating Actuator
		mm (inch)	W	Vdc	Vdc	A	Ohms	
		Ø x L	Max.	Max.	Min.	Max.	Max.	
59010	Ultra-Mini Firecracker	3.13 (0.123) x 9.00 (0.354)	10	170	175	0.25	0.25	57020
59020	Mini Firecracker	5.10 (0.201) x 15.24 (0.600)	10	170	175	0.25	0.25	57020
59021	Aluminum Mini Firecracker	5.10 (0.201) x 15.24 (0.600)	10	170	175	0.25	0.25	57020
59025	Firecracker, Normally Open	6.22 (0.245) x 25.40 (1.000)	10	200	250	0.5	0.2	57025
	Firecracker, Normally Open High Voltage	6.22 (0.245) x 25.40 (1.000)	10	300	450	0.5	0.2	
	Firecracker, Changeover	6.22 (0.245) x 25.40 (1.000)	5	175	200	0.25	0.2	
	Firecracker, Normally Closed	6.22 (0.245) x 25.40 (1.000)	5	175	200	0.25	0.2	
59030	Firecracker, Normally Open	6.22 (0.245) x 38.10 (1.500)	10	200	250	0.5	0.2	57030
	Firecracker, Normally Open High Voltage	6.22 (0.245) x 38.10 (1.500)	10	300	450	0.5	0.2	
	Firecracker, Changeover	6.22 (0.245) x 38.10 (1.500)	5	175	200	0.25	0.2	
	Firecracker, Normally Closed	6.22 (0.245) x 38.10 (1.500)	5	175	200	0.25	0.2	



FLOAT

Designed for liquid-level sensing applications, this sensor has an integral float magnet and a reed switch.

Product Series	Description	Overall Dimensions	Contact Rating	Switching Voltage	Breakdown Voltage	Switching Current	Contact Resistance, Initial
		mm (inch)	W	Vdc	Vdc	A	Ohms
		Ø x L	Max.	Max.	Min.	Max.	Max.
59630	Float Sensor, Normally Open	23.70 (0.930) x 43.70 (1.720)	10	200	250	0.5	0.2
	Float Sensor, Normally Open High Voltage	23.70 (0.930) x 43.70 (1.720)	10	300	450	0.5	0.2
	Float Sensor, Changeover	23.70 (0.930) x 43.70 (1.720)	5	175	200	0.25	0.2
	Float Sensor, Normally Closed	23.70 (0.930) x 43.70 (1.720)	5	175	200	0.25	0.2
59300	Level Sensor, Normally Open (Float Not Included)	19.90 (0.783) x 67.55 (2.660)	10	200	250	0.5	0.2



VANE

Packaged with a magnet and a reed switch, this sensor is typically used in applications with a moving ferrous metal part.

Product Series	Description	Overall Dimensions	Contact Rating	Switching Voltage	Breakdown Voltage	Switching Current	Contact Resistance, Initial
		mm (inch)	W	Vdc	Vdc	A	Ohms
		L x W x H	Max.	Max.	Min.	Max.	Max.
59085	Vane Sensor, Normally Open	25.40 (1.000) x 19.05 (0.750) x 6.35 (0.250)	5	175	200	0.25	0.2
	Vane Sensor, Changeover	25.40 (1.000) x 19.05 (0.750) x 6.35 (0.250)	5	175	200	0.25	0.2
	Vane Sensor, Normally Closed	25.40 (1.000) x 19.05 (0.750) x 6.35 (0.250)	10	200	250	0.5	0.2
	Vane Sensor, Normally Closed High Voltage	25.40 (1.000) x 19.05 (0.750) x 6.35 (0.250)	10	300	450	0.5	0.2
59090	Heavy Duty Vane Sensor, Normally Closed	32.50 (1.280) x 32.25 (1.271) x 23.25 (0.915)	10	200	250	0.5	0.2
	Heavy Duty Vane Sensor, Normally Closed High Voltage	32.50 (1.280) x 32.25 (1.271) x 23.25 (0.915)	10	300	450	0.5	0.2
	Heavy Duty Vane Sensor, Changeover	32.50 (1.280) x 32.25 (1.271) x 23.25 (0.915)	5	175	200	0.25	0.2



SEAT OCCUPANCY

Packaged with an integral magnet and a reed switch, this sensor is available in a push-button configuration or a dome configuration for weight/load distribution.

Product Series	Description	Overall Dimensions	Contact Rating	Switching Voltage	Breakdown Voltage	Switching Current	Contact Resistance, Initial
		mm (inch)	W	Vdc	Vdc	A	Ohms
		L x W x H	Max.	Max.	Min.	Max.	Max.
59250	Push-button Seat Sensor (Reed)	32.51 (1.280) x 26.67 (1.050) x 37.34 (1.470)	10	200	250	0.5	0.2
59251	Seat Sensor with Dome (Reed)	108.20 (4.260) x 69.85 (2.750) x 39.88 (1.570)	10	200	250	0.5	0.2



THREADED BARREL

Designed with a cylindrical package, this sensor is available with English and metric threads. It may easily be mounted and adjusted using the supplied retaining nuts.

Product Series	Description	Overall Dimensions	Contact Rating	Switching Voltage	Breakdown Voltage	Switching Current	Contact Resistance, Initial	Mating Actuator
		mm (inch)	W	Vdc	Vdc	A	Ohms	
		Thread Pitch x L	Max.	Max.	Min.	Max.	Max.	
59060	Stainless Steel Threaded Barrel Sensor, Normally Open	M8 x 1.25 Pitch x 36.00 (1.420)	10	200	250	0.5	0.2	57060
	Stainless Steel Threaded Barrel Sensor, Normally Open High Voltage	M8 x 1.25 Pitch x 36.00 (1.420)	10	300	450	0.5	0.2	
	Stainless Steel Threaded Barrel Sensor, Changeover	M8 x 1.25 Pitch x 36.00 (1.420)	5	175	200	0.25	0.2	
	Stainless Steel Threaded Barrel Sensor, Normally Closed	M8 x 1.25 Pitch x 36.00 (1.420)	5	175	200	0.25	0.2	
59065	Threaded Barrel Sensor (Standard), Normally Open	(5/16 x 24) Pitch x 38.10 (1.500)	10	200	250	0.5	0.2	57065
	Threaded Barrel Sensor (Standard), Normally Open High Voltage	(5/16 x 24) Pitch x 38.10 (1.500)	10	300	450	0.5	0.2	
	Threaded Barrel Sensor (Standard), Changeover	(5/16 x 24) Pitch x 38.10 (1.500)	5	175	200	0.25	0.2	
	Threaded Barrel Sensor (Standard), Normally Closed	(5/16 x 24) Pitch x 38.10 (1.500)	5	175	200	0.25	0.2	
59070	Threaded Barrel Sensor (Metric), Normally Open	M8 x 1.25mm Pitch x 38.10 (1.500)	10	200	250	0.5	0.2	57070
	Threaded Barrel Sensor (Metric), Normally Open High Voltage	M8 x 1.25mm Pitch x 38.10 (1.500)	10	300	450	0.5	0.2	
	Threaded Barrel Sensor (Metric), Changeover	M8 x 1.25mm Pitch x 38.10 (1.500)	5	175	200	0.25	0.2	
	Threaded Barrel Sensor (Metric), Normally Closed	M8 x 1.25mm Pitch x 38.10 (1.500)	5	175	200	0.25	0.2	
59075	Heavy Duty Threaded Barrel, Normally Open	M12 x 1mm Pitch x 46.00 (1.810)	10	200	250	0.5	0.2	57075
	Heavy Duty Threaded Barrel, Normally Open High Voltage	M12 x 1mm Pitch x 46.00 (1.810)	10	300	450	0.5	0.2	
	Heavy Duty Threaded Barrel, Changeover	M12 x 1mm Pitch x 46.00 (1.810)	5	175	200	0.25	0.2	
	Heavy Duty Threaded Barrel, Normally Closed	M12 x 1mm Pitch x 46.00 (1.810)	5	175	200	0.25	0.2	



FLANGE/FLAT PACK

This sensor offers a rectangular package that is designed for mounting on a flat surface. It is suitable for use in a wide range of environments, including high-temperature applications.

Product Series	Description	Overall Dimensions	Contact Rating	Switching Voltage	Breakdown Voltage	Switching Current	Contact Resistance, Initial	Mating Actuator
		mm (inch)	W	Vdc	Vdc	A	Ohms	
		L X W X H	Max.	Max.	Min.	Max.	Max.	
59105	Terminal Flange Mount Sensor, Normally Open	40.17 (1.582) x 19.05 (0.750) x 6.60 (0.260)	10	200	250	0.5	0.2	57105
	Terminal Flange Mount Sensor, Normally Open High Voltage	40.17 (1.582) x 19.05 (0.750) x 6.60 (0.260)	10	300	450	0.5	0.2	
	Terminal Flange Mount Sensor, Normally Closed	40.17 (1.582) x 19.05 (0.750) x 6.60 (0.260)	5	175	200	0.25	0.2	
59125	Pinned Flange Mount Sensor, Normally Open	28.57 (1.125) x 19.05 (0.750) x 6.35 (0.250)	10	200	250	0.5	0.2	57125
	Pinned Flange Mount Sensor, Normally Open High Voltage	28.57 (1.125) x 19.05 (0.750) x 6.35 (0.250)	10	300	450	0.5	0.2	
	Pinned Flange Mount Sensor, Normally Closed	28.57 (1.125) x 19.05 (0.750) x 6.35 (0.250)	5	175	200	0.25	0.2	
59135	High-Temp Flange Mount Sensor, Normally Open	28.57 (1.125) x 19.05 (0.750) x 6.35 (0.250)	10	200	250	0.5	0.2	57135
	High-Temp Flange Mount Sensor, Normally Open High Voltage	28.57 (1.125) x 19.05 (0.750) x 6.35 (0.250)	10	300	450	0.5	0.2	
	High-Temp Flange Mount Sensor, Changeover	28.57 (1.125) x 19.05 (0.750) x 6.35 (0.250)	5	175	200	0.25	0.2	
	High-Temp Flange Mount Sensor, Normally Closed	28.57 (1.125) x 19.05 (0.750) x 6.35 (0.250)	5	175	200	0.25	0.2	
59140	Mini Flange Mount Sensor, Normally Open	23.0 (0.906) x 14.00 (0.551) x 6.00 (0.236)	10	200	250	0.5	0.2	57140
	Mini Flange Mount Sensor, Normally Open High Voltage	23.0 (0.906) x 14.00 (0.551) x 6.00 (0.236)	10	300	450	0.5	0.2	
	Mini Flange Mount Sensor, Changeover	23.0 (0.906) x 14.00 (0.551) x 6.00 (0.236)	5	175	200	0.25	0.2	
	Mini Flange Mount Sensor, Normally Closed	23.0 (0.906) x 14.00 (0.551) x 6.00 (0.236)	5	175	200	0.25	0.2	
59141	Mini Flange Mount Sensor, Normally Open	23.0 (0.906) x 14.00 (0.551) x 6.00 (0.236)	10	200	250	0.5	0.2	57140
	Mini Flange Mount Sensor, Normally Open High Voltage	23.0 (0.906) x 14.00 (0.551) x 6.00 (0.236)	10	300	450	0.5	0.2	
	Mini Flange Mount Sensor, Changeover	23.0 (0.906) x 14.00 (0.551) x 6.00 (0.236)	5	175	200	0.25	0.2	
	Mini Flange Mount Sensor, Normally Closed	23.0 (0.906) x 14.00 (0.551) x 6.00 (0.236)	5	175	200	0.25	0.2	
59145	Flange Mount Sensor, Normally Open	28.57 (1.125) x 19.05 (0.750) x 6.35 (0.250)	10	200	250	0.5	0.2	57145
	Flange Mount Sensor, Normally Open High Voltage	28.57 (1.125) x 19.05 (0.750) x 6.35 (0.250)	10	300	450	0.5	0.2	
	Flange Mount Sensor, Changeover	28.57 (1.125) x 19.05 (0.750) x 6.35 (0.250)	5	175	200	0.25	0.2	
	Flange Mount Sensor, Normally Closed	28.57 (1.125) x 19.05 (0.750) x 6.35 (0.250)	5	175	200	0.25	0.2	
59150	Flange Mount Sensor, Normally Open	28.57 (1.125) x 19.05 (0.750) x 6.35 (0.250)	10	200	250	0.5	0.2	57150
	Flange Mount Sensor, Normally Open High Voltage	28.57 (1.125) x 19.05 (0.750) x 6.35 (0.250)	10	300	450	0.5	0.2	
	Flange Mount Sensor, Changeover	28.57 (1.125) x 19.05 (0.750) x 6.35 (0.250)	5	175	200	0.25	0.2	
	Flange Mount Sensor, Normally Closed	28.57 (1.125) x 19.05 (0.750) x 6.35 (0.250)	5	175	200	0.25	0.2	



LEVER ARM

This clip frame sensor with a lever arm is ideally suited for paper-path sensing and security system applications.

Product Series	Description	Overall Dimensions	Contact Rating	Switching Voltage	Breakdown Voltage	Switching Current	Contact Resistance, Initial
		mm (inch)	W	Vdc	Vdc	A	Ohms
		L x W x H	Max.	Max.	Min.	Max.	Max.
59210	Lever Arm Sensor	24 (0.945) x 23 (0.906) x 10 (0.394)	10	200	250	0.5	0.2

Reed Relays



DUAL-IN-LINE (DIL)

Reed relay products are available in standard dual-in-line packages for mounting on a printed circuit board or socket.

Product Series	Description	Overall Dimensions		Coil Voltage		Coil Resistance	Contact Ratings, Switching			Contact Form
		Transfer Molded Body	External Shield Body	Vdc	Vdc	Ohms	Vdc	A	W	
		mm (inch)	mm (inch)	Nominal	Max.	Nominal	Max.	Max.	Max.	
		L x W x H	L x W x H							
HE721A0500	Reed Relay, DIL, SPST-NO	39.50 (0.768) x 7.22 (0.284) x 5.50 (0.217)	20.14 (0.793) x 7.62 (0.300) x 5.82 (0.229)	5	12	500	200	0.5	10	Form A
HE721A1200				12	31	1000				
HE721A2400				24	46	2150				
HE721B0500	Reed Relay, DIL, SPST-NC	39.50 (0.768) x 7.22 (0.284) x 5.50 (0.217)	20.14 (0.793) x 7.62 (0.300) x 5.82 (0.229)	5	6.5	500	200	0.5	10	Form B
HE721B1200				12	14	1000				
HE721B2400				24	28	2150				
HE721C0500	Reed Relay, DIL, SPDT-CO	39.50 (0.768) x 7.22 (0.284) x 5.50 (0.217)	20.14 (0.793) x 7.62 (0.300) x 5.82 (0.229)	5	14	200	175	0.25	5	Form C
HE721C1200				12	22	500				
HE721C2400				24	44	2000				
HE721E0500	Reed Relay, DIL, SPDT-CO	39.50 (0.768) x 7.22 (0.284) x 5.50 (0.217)	20.14 (0.793) x 7.62 (0.300) x 5.82 (0.229)	5	14	200	175	0.25	5	Form C
HE721E1200				12	22	500				
HE721E2400				24	44	2000				
HE721R0500	Reed Relay, DIL, SPDT-CO	39.50 (0.768) x 7.22 (0.284) x 5.50 (0.217)	20.14 (0.793) x 7.62 (0.300) x 5.82 (0.229)	5	14	200	175	0.25	5	Form C
HE721R1200				12	22	500				
HE721R2400				24	44	2000				
HE722A0500	Reed Relay, DIL, DPST-NO	39.50 (0.768) x 7.22 (0.284) x 5.50 (0.217)	20.14 (0.793) x 7.62 (0.300) x 5.82 (0.229)	5	12	200	200	0.5	10	Form A
HE722A1200				12	22	500				
HE722A2400				24	46	2000				
HE751A0500	Reed Relay, DIL, SPST-NO, High Voltage	39.50 (0.768) x 7.22 (0.284) x 5.50 (0.217)	20.14 (0.793) x 7.62 (0.300) x 5.82 (0.229)	5	12	500	300	0.5	10	Form A
HE751A1200				12	21	1000				
HE751A2400				24	46	2150				



SINGLE-IN-LINE (SIL)

Reed relay products are available in standard single-in-line packages for mounting on a printed circuit board or socket.

Product Series	Description	Overall Dimensions		Coil Voltage		Coil Resistance	Contact Ratings, Switching			Contact Form
		Transfer Molded Body	External Shield Body	Vdc	Vdc	Ohms	Vdc	A	W	
		mm (inch)	mm (inch)	Nominal	Max.	Nominal	Max.	Max.	Max.	
		L x W x H	L x W x H							
HE3321A0400	Reed Relay, SIL, SPST-NO	24.13 (0.950) x 7.00 (0.276) x 7.40 (0.291)	24.90 (0.980) x 7.60 (0.299) x 7.80 (0.307)	5	22	500	200	0.5	10	Form A
HE3321A1200				12	22	500				
HE3321A2400				24	44	2000				
HE3321C0500	Reed Relay, SIL, SPDT-CO	24.13 (0.950) x 7.00 (0.276) x 7.40 (0.291)	24.90 (0.980) x 7.60 (0.299) x 7.80 (0.307)	5	11	125	175	0.25	5	Form C
HE3321C1200				12	22	500				
HE3321C2400				24	44	2000				
HE3351A0500	Reed Relay, SIL, SPST-NO, High Voltage	24.13 (0.950) x 7.00 (0.276) x 7.40 (0.291)	24.90 (0.980) x 7.60 (0.299) x 7.80 (0.307)	5	14	125	300	0.5	10	Form A
HE3351A1200				12	22	500				
HE3351A2400				24	44	2000				



MINIATURE SINGLE-IN-LINE (SIL)

Reed relay products are available in smaller profile single-in-line packages for mounting on a printed circuit board or socket.

Product Series	Description	Overall Dimensions		Coil Voltage		Coil Resistance	Contact Ratings, Switching			Contact Form
		Transfer Molded Body	External Shield Body	Vdc	Vdc	Ohms	Vdc	A	W	
		mm (inch)	mm (inch)	Nominal	Max.	Nominal	Max.	Max.	Max.	
		L x W x H	L x W x H							
HE3621A0500	Reed Relay, SIL, SPST-NO	19.05 (0.750) x 5.08 (0.200) x 7.45 (0.293)	19.70 (0.776) x 5.65 (0.222) x 7.87 (0.310)	5	14	500	200	0.5	10	Form A
HE3621A1200				12	22	1000				
HE3621A2400				24	31	2150				
HE3671A0500	Reed Relay, SIL, SPST-NO, Data Switching	19.05 (0.750) x 5.08 (0.200) x 7.45 (0.293)	19.70 (0.776) x 5.65 (0.222) x 7.87 (0.310)	5	14	500	200	0.5	10	Form A
HE3671A1200				12	22	1000				
HE3671A2400				24	31	2150				

Magnetic Actuators



RECTANGULAR

These rectangular bare magnets and packaged actuators are ideally suited for mounting on a flat surface. They are suitable for use in a wide range of environments, including high-temperature applications.

Product Series	Description	Overall Dimensions		Material	Recommended Operating Temp.	
		mm (inch)			°C	Max.
		L x W x H				
H-31	AlNiCo Magnet	12.70 (0.500) x 1.60 (0.062) x 1.60 (0.062)		AlNiCo-5	300	
H-32	AlNiCo Magnet	25.40 (1.000) x 4.80 (0.190) x 4.80 (0.190)		AlNiCo-5	300	
H-33	AlNiCo Magnet	19.10 (0.750) x 3.20 (0.120) x 3.20 (0.120)		AlNiCo-5	300	
H-34	AlNiCo Magnet	25.40 (1.000) x 6.35 (0.250) x 6.35 (0.250)		AlNiCo-5	300	
H-40	Neodymium Magnet	7.62 (0.300) x 3.18 (0.125) x 3.18 (0.125)		NdFeB 45H	120	
H-41	Neodymium Magnet	19.05 (0.750) x 3.18 (0.125) x 3.18 (0.125)		NdFeB 35H	120	
H-58	Neodymium Magnet	21.00 (0.827) x 7.00 (0.276) x 4.70 (0.185)		NdFeB 35H	120	
57105	Actuator for Terminal Flange Mount Sensor	40.17 (1.582) x 19.05 (0.750) x 6.35 (0.250)		AlNiCo-5	105	
57125	Actuator for Pinned Flange Mount Sensor	28.57 (1.125) x 19.05 (0.750) x 6.35 (0.250)		AlNiCo-5	300	
57135	Actuator for High-Temp Flange Mount Sensor	28.57 (1.125) x 19.05 (0.750) x 6.35 (0.250)		AlNiCo-5	150	
57140	Actuator for Mini Flange Mount Sensor	23.00 (0.906) x 14.00 (0.551) x 6.00 (0.236)		AlNiCo-5	105	
57141	Actuator for Mini Flange Mount Sensor	23.00 (0.906) x 14.00 (0.551) x 6.00 (0.236)		NdFeB 35H	105	
57145	Actuator for Flange Mount Sensor	28.57 (1.125) x 19.05 (0.750) x 6.35 (0.250)		AlNiCo-5	105	
57150	Actuator for Flange Mount Sensor	28.57 (1.125) x 19.05 (0.750) x 6.35 (0.250)		AlNiCo-5	105	
57045	Actuator for Mini PCB Mount Overmolded	17.78 (0.700) x 3.30 (0.130) x 4.32 (0.170)		AlNiCo-5	105	
57050	Actuator for PCB Mount Overmolded	22.86 (0.900) x 4.57 (0.180) x 4.57 (0.180)		AlNiCo-5	105	



CYLINDRICAL

Designed for mounting on a frame, these cylindrical bare magnets and packaged actuators are appropriate for use in a wide range of environments, including high-temperature applications.

Product Series	Description	Overall Dimensions		Material	Recommended Operating Temp.	
		mm (inch)			°C	Max.
		Ø x L				
H-35	Neodymium Magnet	6.35 (0.250) x 6.35 (0.250)		NdFeB 35H	120	
H-48	Neodymium Magnet	4.40 (0.173) x 6.00 (0.236)		NdFeB 35SH	120	
CM-1	Ceramic Magnet	12.70 (0.500) x 5.08 (0.200)		Ceramic-5	125	
H-36	AlNiCo Magnet	4.60 (0.182) x 25.40 (1.000)		AlNiCo-5	300	
H-315	AlNiCo Magnet	3.00 (0.118) x 15.00 (0.590)		AlNiCo-5	300	
H-420	AlNiCo Magnet	4.00 (0.157) x 20.0 (0.787)		AlNiCo-5	300	
H-625	AlNiCo Magnet	6.00 (0.236) x 25.0 (0.984)		AlNiCo-5	300	
57020	Actuator for Mini Firecracker	5.10 (0.201) x 15.24 (0.600)		AlNiCo-5	105	
57022	Actuator for Firecracker	5.80 (0.228) x 25.40 (1.000)		AlNiCo-5	105	
57025	Actuator for Firecracker	6.22 (0.245) x 25.40 (1.000)		AlNiCo-5	105	
57030	Actuator for Long Firecracker	6.22 (0.245) x 38.10 (1.500)		AlNiCo-5	105	
57060	Actuator for Stainless Threaded Barrel Sensor	M8 x 1.25 Pitch x 36.00 (1.420)		AlNiCo-5	105	
57065	Actuator for Threaded Barrel Sensor (Standard)	(5/16 x 24) Pitch x 38.10 (1.500)		AlNiCo-5	105	
57070	Actuator for Threaded Barrel Sensor (Metric)	M8 x 1.25 Pitch x 38.10 (1.500)		AlNiCo-5	105	
57075	Actuator for Heavy Duty Threaded Barrel	M12 x 1.00 Pitch x 46.00 (1.810)		Ceramic-2	125	

Applications



PROXIMITY SENSING USING REED SENSORS— Refrigerator Door

Appliances like refrigerators, freezers and wine coolers are used to keep food/ beverages cold and extend their useful life. These appliances contain lights to illuminate the inside compartments when the doors are open. However, the lights only need to turn on when a door is open. To accomplish this, a proximity sensor is needed to detect if the appliance door is open or closed.

A reed sensor can be used to detect the position of the door. In refrigerators, a reed sensor is mounted to the frame of the appliance and a permanent magnet is mounted to each door. Each reed sensor and magnet pair is positioned so that the reed switch contacts close only when the door is completely closed. The position of the reed sensor's contacts can be monitored by an electronic control unit (ECU) within the refrigerator's electronics assembly to turn the interior lights on and off as needed.

Reed sensors are ideal for a variety of position- and proximity-sensing applications where there is a need to detect the presence of a moving part in relation to a sensor in a fixed location.

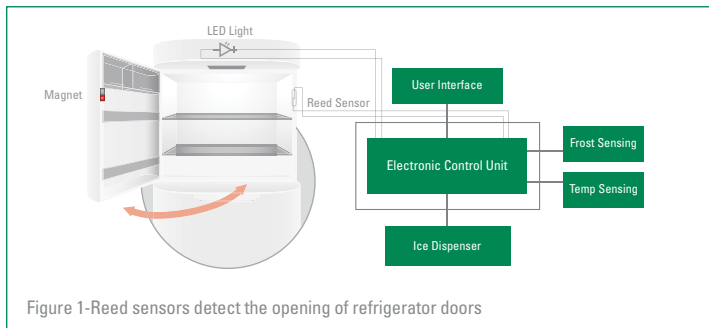

Features and Benefits:

- No physical contact required to operate the switch
- Zero power required for switch actuation
- Electrical contacts are within a hermetically sealed capsule that is immune to moisture, dust and dirt
- Wide operating temperature range adequate for use in cold temperatures
- Overmolded sensors provide additional protection against mechanical stresses and vibration
- Low-cost alternative to mechanical switch

Suggested Products:

- FLEX-14 (14 mm reed switch)
- MDCG-4 (15 mm reed switch)
- MDSR-10 (10 mm reed switch)
- 59025 (Firecracker reed sensor)
- 59140 (Flange mount reed sensor)

Similar Applications:

Refrigerators/freezers, dish washers, washing machines, rice cookers, coffee makers, vacuum cleaners and vending machines



PROXIMITY SENSING USING HALL EFFECT SENSORS— Garage Door

Hall effect sensors can be used to detect the movement of a garage door to stop the motor once the door has reached its open or closed position. Typically, a system of two Hall effect sensors, each associated with its own permanent magnet, is used to determine whether the door is completely open, completely closed or somewhere in between.

One of the magnets is mounted on the chain drive of the garage door opener so that it is positioned directly next to the Hall effect sensor used to detect a closed door. The other magnet is positioned so that it moves with the chain and is located directly next to the other Hall effect sensor when the door is completely open.

Similar to reed sensors, Hall effect sensors are ideal for position or proximity sensing where there is a need to detect the presence of a moving part in relation to one or more sensors in fixed locations. They offer extended life and reliability over reed sensors since there are no electrical contacts that are opened and closed. Common examples include door- and lid-position sensing in the similar applications listed.

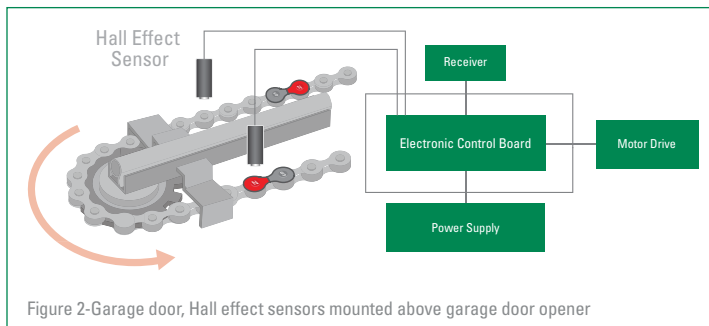

Features and Benefits:

- No physical contact required to operate the switch
- Wide operating temperature range adequate for use in hot and cold temperatures
- Hall effect sensor is an integrated circuit with no mechanical moving components
- Encapsulated sensors provide additional protection against environmental/mechanical stresses and vibration
- Reliable operation for millions of cycles
- Low-cost alternative to mechanical switches or infrared/optical sensors

Suggested Products:

- 55100 (Miniature flange mount Hall effect sensor)
- 55140 (Flange mount Hall effect sensor)
- 55310 (Flat pack digital Hall effect sensor)

Similar Applications:

Dishwashers, washing machines, vacuum cleaners, security locks on doors and vending machines



SPEED SENSING USING REED SENSORS— Treadmill Pulley

Reed switch-based sensors are used as highly effective speed sensors in low-cycle-rate applications with rates up to a few thousand revolutions per minute (RPM). For example, in treadmills, a reed sensor is used to detect the speed of the moving belt. Two permanent magnets are placed on diametrically opposite ends of the belt pulley, and a reed sensor is mounted to the treadmill frame perpendicular to one end of the pulley. As the treadmill pulley rotates, the reed sensor detects when each of the magnets is close to the sensor. The time interval between the detection of each magnet is used to compute the speed at which the pulley is rotating.

Reed sensors are highly accurate in speed-sensing applications where there is a rotating part. They are commonly used in fitness equipment where there is a rotating part with a variable speed.

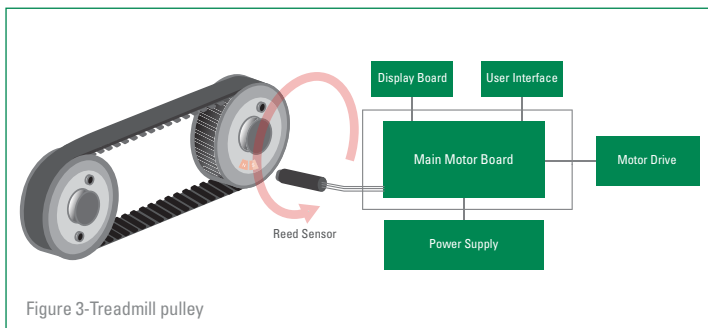

Figure 3-Treadmill pulley

Features and Benefits:

- Effective, noncontact solution used to switch the sensor
- Digital output signal is used to compute speed with high accuracy
- Long lifetime and reliable sensing for millions of operations
- Low-cost alternative to infrared/optical sensors
- Overmolded sensors provide additional protection against mechanical stresses and vibration

Suggested Products:

- 59025 (Firecracker)
- 59065 (Threaded barrel)
- 59140 (Miniature flange mount)
- 59150 (Flange mount)

Similar Applications:

Fitness equipment, including treadmill, stationary bicycle and elliptical cross-trainer



SPEED SENSING USING HALL EFFECT SENSORS— Washing Machine Drum Speed

Hall effect sensors make very effective rotary speed sensors. The strengths of these sensors are their reliability, repeatability, accuracy and high speed. For example, in a clothes washing machine, a digital or latching Hall effect sensor can be used to detect a rotating ring magnet to determine the rotating speed of the drum. Multipole magnets (e.g., 8–40 poles) are typically used as the ring magnets in these designs. The frequency and resolution of speed are affected by the number of magnet poles.

Direction, as well as speed, can be measured. The direction signal can be provided by either quadrature signaling or with the direction encoded in the pulse width. Quadrature signaling involves two square wave speed signals where the direction of rotation is determined by the lead vs. lag phase relationship between the two signals.

Another popular method of detecting speed is to use Hall effect speed sensors to detect rotating ferrous gear teeth such as in an automotive transmission speed sensor application. The Hall effect sensor has a back-bias magnet and detects the variation in magnetic flux density between the gear tooth and the Hall effect sensor.

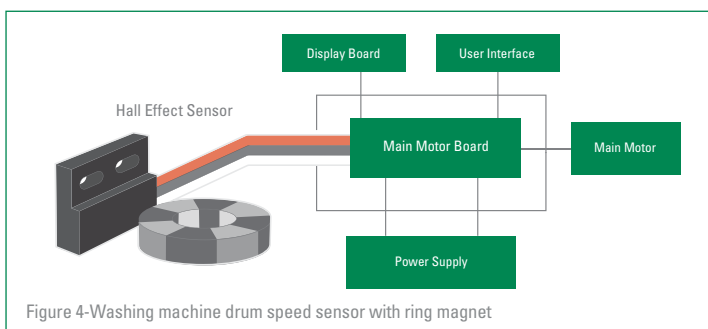

Figure 4-Washing machine drum speed sensor with ring magnet

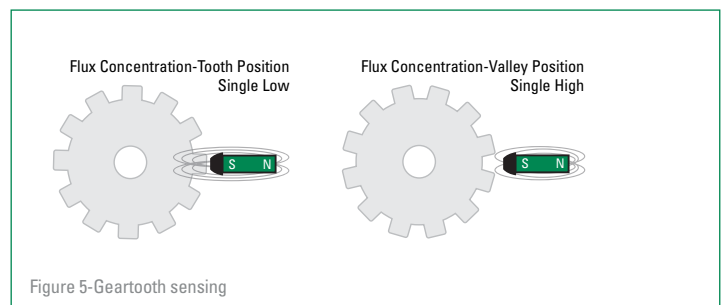

Figure 5-Gear tooth sensing

Features and Benefits:

- Digital output signal is used to compute speed with high accuracy
- Long lifetime and reliable sensing for millions of operations
- Effective for high-speed applications

Suggested Products:

- 55140 (Flange mount)
- 55310 (Flat pack digital)
- 55505 (Gear tooth sensor)
- 55075 (Gear tooth sensor)
- Custom-designed sensor

Similar Applications:

DC motors, vacuum cleaners and wheel speed



SECURITY AND ALARM SYSTEMS— Door and Window Alarms

Many types of security alarm systems use a reed switch/sensor attached to the frame of the door or window. The actuating magnet is attached to the moving door or window so that when it is opened, the reed sensor detects the moving magnet and opens/closes its electrical contacts—sending a signal to the alarm system.

Similarly, reed switches can easily be mounted to circuit boards used in smoke or gas alarm systems. In portable systems, such as gas detectors, the reed switch is used to activate the system when the handheld detector or reader is placed in the docking station. In systems with smoke/gas detectors in fixed positions, the reed switch can be activated with a handheld magnetic wand to put the detector in test mode.

Reed switches and reed sensors are effective solutions for many types of security and alarm sensor applications. Examples include detecting the door and window position, measuring the sump pump water level or activating the test mode of a smoke detector. Reed relays can be used to activate the alarm loop in active sensors like motion sensors and smoke detectors.

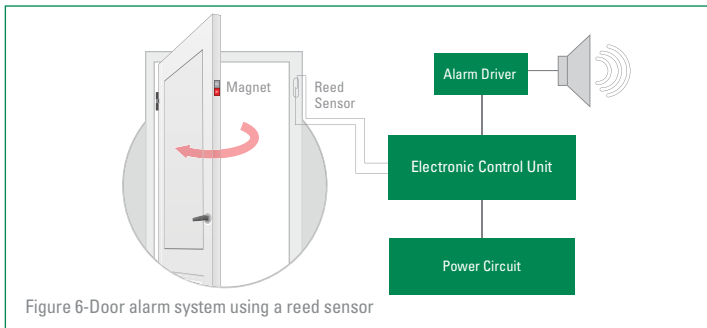

Figure 6—Door alarm system using a reed sensor



CONTINUOUS LEVEL SENSING— Industrial Tank Water Level

Resistive reed ladder networks are used to measure the liquid level in a tank, which allows for a continuous output signal rather than discrete signals from single-point level sensors. This continuous level sensor produces a variable resistance or continuous current/voltage that is related to the position of the float/magnet assembly. As the liquid level changes, the relative float position follows, activating the reeds sequentially and producing the associated output voltage or resistance value. The typical spacing between reed switches is usually provided in 6.35 mm or 12.7 mm steps.

Littelfuse supplies full assemblies that include stainless steel or plastic housings. Bare reed switches are also available.

Level sensors incorporating reed switch and resistance technology are commonly used for measuring continuous liquid levels in the automotive, marine and industrial markets. The float, which contains a magnet, moves up or down over the sealed stem containing the reed switches/resistors.

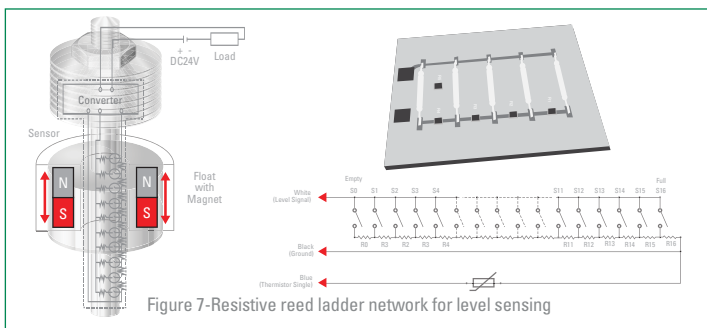

Figure 7—Resistive reed ladder network for level sensing

Features and Benefits:

- No physical contact is required to operate the switch
- Zero power required for switch actuation
- Wide operating temperature range adequate for use in hot and cold temperatures
- Electrical contacts are within a hermetically sealed capsule that is immune to moisture, dust and dirt
- Overmolded sensors provide additional protection against mechanical stresses
- Low-cost alternative to mechanical switches

Suggested Products:

- MDSM-10 (10 mm reed switch)
- 59020 (Miniature firecracker)
- 59140 (Miniature flange mount)
- 59170 (11 mm overmolded reed switch)
- HE3621A0510 (Miniature SIL reed relay)

Similar Applications:

Burglar systems, smoke alarms and gas detection systems

Features and Benefits:

- Continuous level output signal, not like a single-point level sensor
- Electrical contacts are within a hermetically sealed capsule that is immune to moisture, dust and dirt
- Sensor housing provides protection against mechanical stresses and vibration
- Reliable switching for millions of open/close operations
- Wide operating temperature range adequate for use in hot and cold temperatures

Suggested Products:

- MDSM-10 (10 mm reed switch)
- MDSM-4 (15 mm reed switch)
- Custom-designed level sensor assemblies

Similar Applications:

Fluid-level sensing for: urea in diesel trucks, fuel tanks, HVAC refrigerator tanks and condensate water tanks



LEVEL SENSING— Dishwasher Water Level

When provided with a float magnet, reed sensors can function as fluid-level sensors. For example, in a dishwasher, a float-type level sensor is used to detect if the water level inside of the water collection pan has reached the fill limit. The float sensor consists of a reed switch mounted within a shaft and a permanent magnet provided within a float housing. The shaft is vertically mounted within the water collection pan so that the reed switch is positioned at the water fill limit of the pan. As the water level rises, the magnet within the float travels up the shaft to the point where it comes into the proximity of the reed switch. The reed switch senses the presence of the magnet and signals the dishwasher's ECU that the water level has reached its fill limit.

Level sensors incorporating reed switch technology are low-cost solutions for any application where there is a need to detect the amount of liquid in a tank or pan. They are commonly used in white goods and appliances.

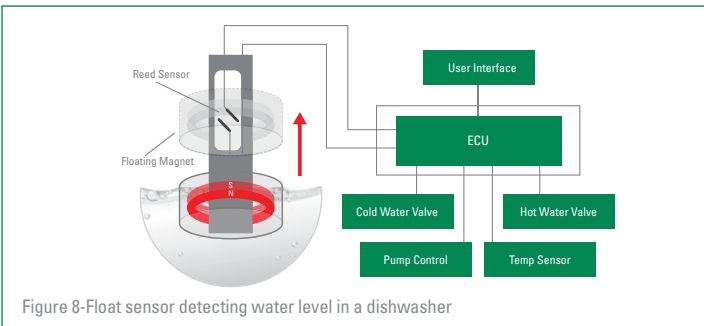

Figure 8-Float sensor detecting water level in a dishwasher



FLOW SWITCH— Tankless Water Heater

A flow switch utilizes a reed switch to detect the motion of a valve, paddle wheel or piston that is fitted with a permanent magnet. For example, in some tankless water heater units, the flow sensor contains a permanent magnet that is fixed to a piston that moves when there is water pressure present in the system. As the water pressure increases, the piston movement brings the magnet into the proximity of the reed switch. This causes the reed switch to close and signals the presence of water flow.

A flow sensor utilizes a turbine with an attached magnet that rotates by a fixed reed switch or Hall effect sensor. The speed at which the turbine rotates is proportional to the flow rate of the fluid.

Reed sensors are highly effective solutions for flow-sensing applications where there is a need to detect the presence of liquid or gas flow in a system. Common uses include water or gas flow in the similar applications listed.

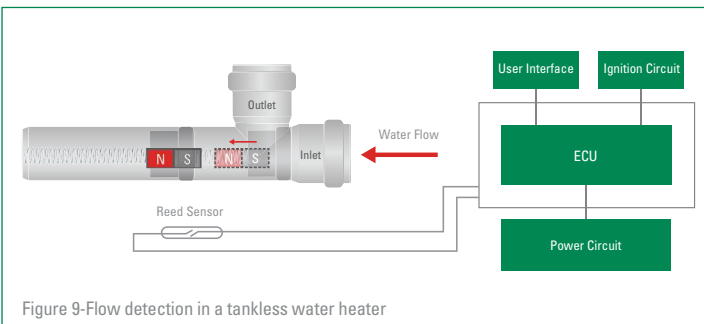

Figure 9-Flow detection in a tankless water heater

Features and Benefits:

- No physical contact required to operate the switch
- Zero power required for switch actuation
- Electrical contacts are within a hermetically sealed capsule that is immune to moisture, dust and dirt
- Wide operating temperature range
- adequate for use in hot and cold temperatures
- Sensor housing provides protection against mechanical stresses and vibration
- Reliable switching for millions of open/close operations

Suggested Products:

- 59630 (Float sensor)
- FLEX-14 (14 mm reed switch)
- MDSR-10 (10 mm reed switch)
- MACD-14 (14 mm reed switch)
- 59300 (Level sensor)

Similar Applications:

Dish washers, washing machines, air conditioners, dehumidifiers and coffee brewers

Features and Benefits:

- No physical contact is required to operate the switch
- Zero power required for switch actuation
- Wide operating temperature range adequate for use in hot and cold temperatures
- Electrical contacts are within a hermetically sealed capsule that is immune to moisture, dust and dirt
- Overmolded sensors provide additional protection against mechanical stresses
- Reliable switching for millions of open/close operations

Suggested Products:

- MDSM-4 (15 mm reed switch)
- MLSM-4 (15 mm reed switch)
- MDCG-4 (15 mm reed switch)
- MDSR-10 (10 mm reed switch)
- 59165 (16 mm overmolded reed switch)
- 59170 (11 mm overmolded reed switch)

Similar Applications:

Dish washers, washing machines, hot tubs and utility gas meters

Beyond Sensing...

LITTELFUSE OFFERS CIRCUIT PROTECTION...

Littelfuse circuit protection products can be used with Hamlin reed switch and sensor products to enhance safety and reliability in various load-switching applications. We recommend using circuit protection for the following examples of load switching:

Inductive Load Switching – Arc suppression is recommended to maximize the operating life of inductive loads. For DC loads, a diode should be used. For AC loads, a transient voltage suppression (TVS) diode, a metal oxide varistor (MOV) or a resistor-capacitor (RC) suppression device may be used. MOV and RC suppression devices should not have too much capacitive inrush current as described below.

Capacitive Load Switching – Capacitance in the load circuit or long cables may cause permanent or intermittent contact sticking. Contact protection is recommended if the energy stored in the capacitor ($E = \frac{1}{2}CV^2$) is greater than 1 μJ . Use a small value resistor in series with the reed switch for contact protection.

A BROAD & DEEP PORTFOLIO

Littelfuse offers the world's broadest and deepest portfolio of circuit protection solutions. Our extensive knowledge and experience in circuit protection technologies are accessible to our customers around the globe. If you have a unique circuit protection problem, we have the expertise and resources needed to develop a solution that delivers exceptional safety and reliability. Our global research and development teams are constantly working on innovative circuit protection technologies designed to safeguard the latest products on the market.

Over-Current Protection

- Fuses
- Resettable positive temperature coefficient (PTC) devices

Over-Voltage Suppression

- Gas discharge tubes (GDTs)
- PLED Series open LED protectors
- PulseGuard® ESD Suppressors
- TVS diodes
- TVS diode arrays
- SIDACTor® devices
- Switching thyristors
- Varistors



Fuse Blocks



Fuse Clips



Fuse Holders

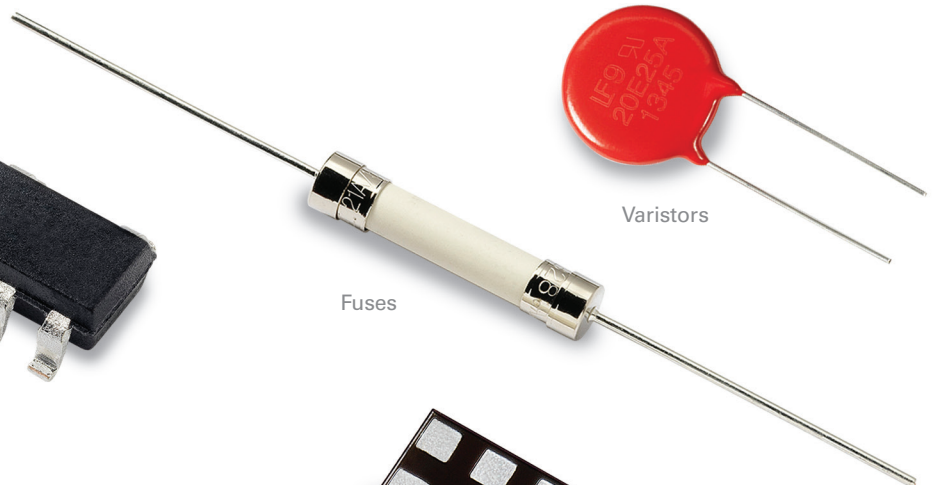

Fuses



Varistors



SIDACTor®
Devices



PLED
LED Protectors



TVS
Diode Arrays



Switching
Thyristors

GLOBAL FOOTPRINT...

At Littelfuse, our mission is to develop innovative circuit protection, power control and sensing solutions that meet our customers' unique needs. This customer-focused philosophy has helped us become the top circuit protection brand in the world.

Our industry-leading product portfolio includes reliable circuit protection, power control and sensing products that are designed for a variety of applications. We have assembled unparalleled expertise and developed a global footprint that puts our facilities close to our customers and target markets. As our global manufacturing and R&D teams objectively recommend the best circuit protection, power control or sensing solution for each customer application, they form partnerships that will lead to the development of the next generation of advanced products.

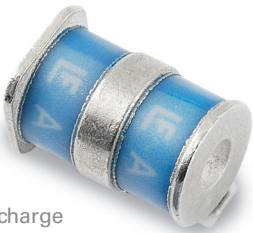
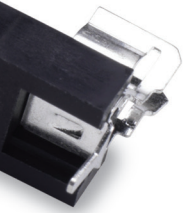

Gas Discharge Tubes

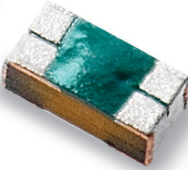

PulseGuard® ESD Suppressors

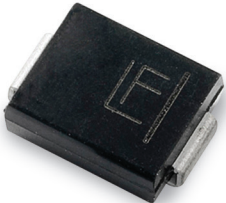

TVS Diodes



Resettable PTC Devices



Expertise Applied | Answers Delivered



Expertise Applied | Answers Delivered

Littelfuse electronics product portfolio includes:

H A M L I N

littelfuse.com
hamlin.com