



Chipsmall Limited consists of a professional team with an average of over 10 year of expertise in the distribution of electronic components. Based in Hongkong, we have already established firm and mutual-benefit business relationships with customers from,Europe,America and south Asia,supplying obsolete and hard-to-find components to meet their specific needs.

With the principle of “Quality Parts,Customers Priority,Honest Operation,and Considerate Service”,our business mainly focus on the distribution of electronic components. Line cards we deal with include Microchip,ALPS,ROHM,Xilinx,Pulse,ON,Everlight and Freescale. Main products comprise IC,Modules,Potentiometer,IC Socket,Relay,Connector.Our parts cover such applications as commercial,industrial, and automotives areas.

We are looking forward to setting up business relationship with you and hope to provide you with the best service and solution. Let us make a better world for our industry!



Contact us

Tel: +86-755-8981 8866 Fax: +86-755-8427 6832

Email & Skype: info@chipsmall.com Web: www.chipsmall.com

Address: A1208, Overseas Decoration Building, #122 Zhenhua RD., Futian, Shenzhen, China



PROPER USE GUIDELINES

Cumulative Trauma Disorders can result from the prolonged use of manually powered hand tools. Hand tools are intended for occasional use and low volume applications. A wide selection of powered application equipment for extended-use, production operations is available.

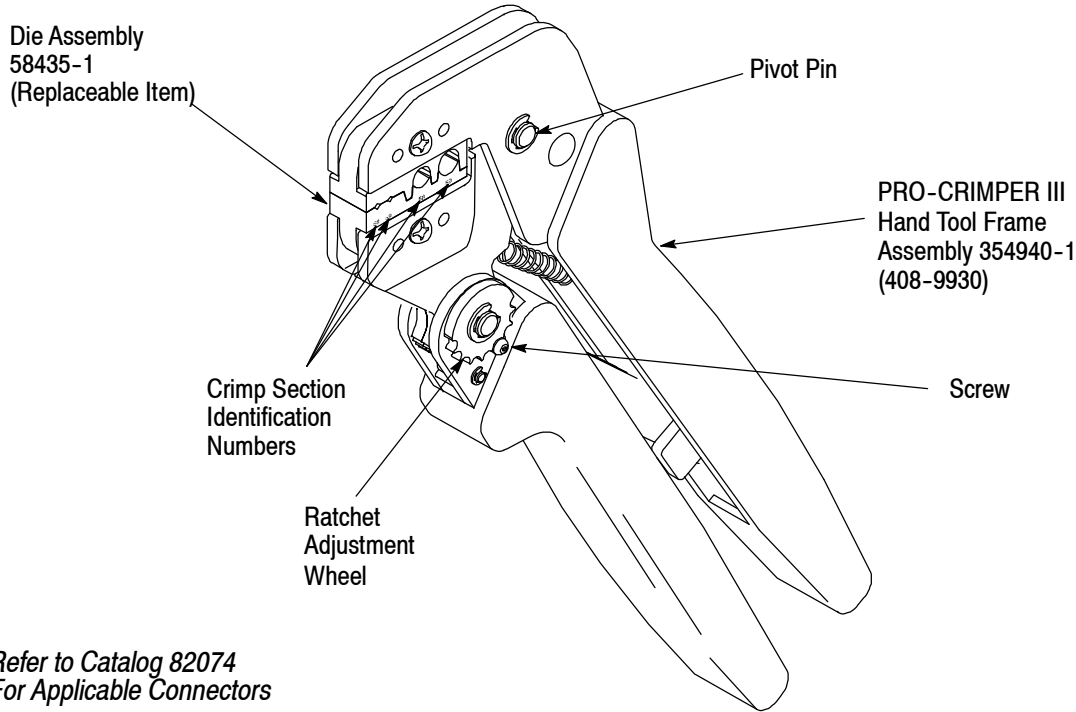

*Refer to Catalog 82074
For Applicable Connectors*

Figure 1

1. INTRODUCTION

PRO-CRIMPER III Hand Crimping Tool 58433-1 (Figure 1) is designed to crimp 50-Ohm Commercial BNC and TNC plugs and jacks onto RG 58/U, RG 59/U, and RG 62/U cable.

Reasons for reissue of this sheet are provided in Section 6, REVISION SUMMARY.

2. DESCRIPTION (Figure 1)

The tool features a replaceable die assembly (58435-1) with two ferrule crimp sections and two center contact crimp sections. The crimp sections are marked to identify the cable sizes used with the connectors as follows:

- RG 58/U crimp sections (center contact and ferrule) are identified by the number “58” located below the crimp section.
- RG 59/U and 62/U crimp sections (center contact and ferrule) are identified by the number “59” located below the crimp section.

3. CRIMPING PROCEDURE (Figure 2)

3.1. Center Contact

1. Slide the ferrule onto the cable, then strip the cable according to the dimensions in the appropriate connector instruction sheet.
2. Slide the center contact onto the center conductor of the cable; then insert the contact assembly into the contact crimp section of the dies.

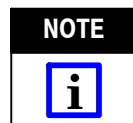

Make sure that the flange on the end of the center contact butts against the crimping die. See Figure 3.

3. Crimp the center contact by holding the contact and cable in place; then close the tool handles until the ratchet releases.
4. Remove the crimped center contact.

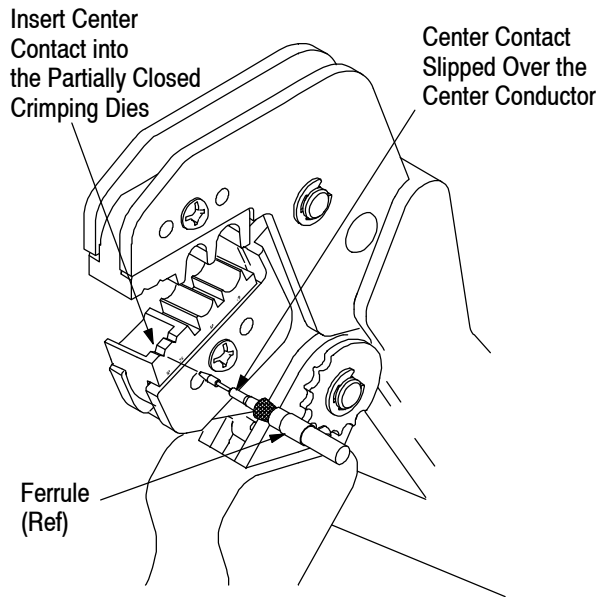

Figure 2

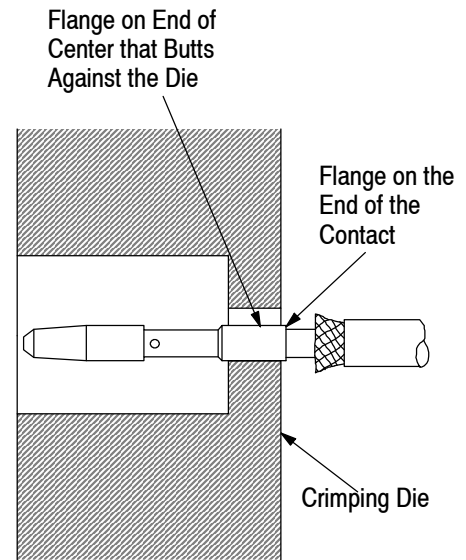

Figure 3

3.2. Ferrule

1. Insert the crimped center contact into the connector body until the cable dielectric butts against the dielectric inside the connector body. The flared braid will then fit around the support sleeve of the connector body.
2. Slide the ferrule forward over the braid until the ferrule butts against the shoulder on the connector body.
3. Place the ferrule on the appropriate anvil of the die assembly so that the shoulder on the connector body butts against the die. See Figure 4.
4. Holding the assembly in place, close the tool handles until the ratchet releases.
5. Remove the crimped assembly.

4. INSPECTION

4.1. Visual Inspection

Inspection of the crimping dies should be made on a regular basis to ensure that they have not become worn or damaged. Inspect the crimp sections for flattened, chipped, worn, or broken areas. If damage or abnormal wear is evident, the dies must be replaced. Refer to Section 5, PARTS REPLACEMENT.

4.2. Measuring Die Opening

The die assembly will perform correctly as long as:

- a. the product specified is correct for the application,
- b. the specific die assembly is used,
- c. the die assembly has been measured to ensure that the openings are correct, and
- d. the tool has been adjusted correctly.

Figure 5 provides information on die opening sizes.

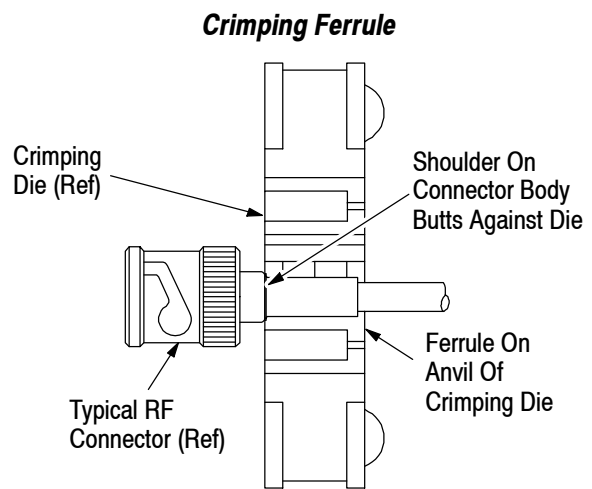

Figure 4

4.3. Ratchet Adjustment

The ratchet mechanism features an adjustment wheel with eight settings. The adjustment wheel controls the amount of handle pressure exerted on the tool jaws and crimping dies during crimping. If the crimp is not acceptable, adjust the ratchet as follows:

1. Sufficiently loosen the screw at the ratchet adjustment wheel so that the wheel can be rotated above the post that engages the teeth in the wheel.
2. If the crimp is too loose, turn the wheel to a higher notch (for example, if the wheel is set at notch no. 5, move the wheel to notch no. 6). If the crimp is too tight, move the wheel to a lower notch.
3. Tighten the screw at the ratchet adjustment wheel.

If the crimp cannot be made to conform to the dimensions provided in the appropriate product application specification, the tool and/or dies are defective and must be replaced.

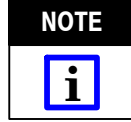

Other dies of the PRO-CRIMPER III Series Hand Crimping Tool may be used in this tool; however, the ratchet adjustment wheel may require adjustment to achieve acceptable crimp height.

5. PARTS REPLACEMENT

Customer-replaceable parts are shown in Figure 1. Available separately, PRO-CRIMPER III Repair Kit 679221-1 includes a variety of pins, rings, screws, and springs. If the dies are damaged or worn excessively, they must be replaced. Order the repair kit and replaceable parts through your TE Connectivity Representative, or call 1-800-526-5142, or send a facsimile of your purchase order to 1-717-986-7605, or write to:

Customer Service (38-35)
 Tyco Electronics Corporation
 P.O. Box 3608
 Harrisburg, PA 17105-3608

6. REVISION SUMMARY

- Updated document to corporate requirements
- New logo

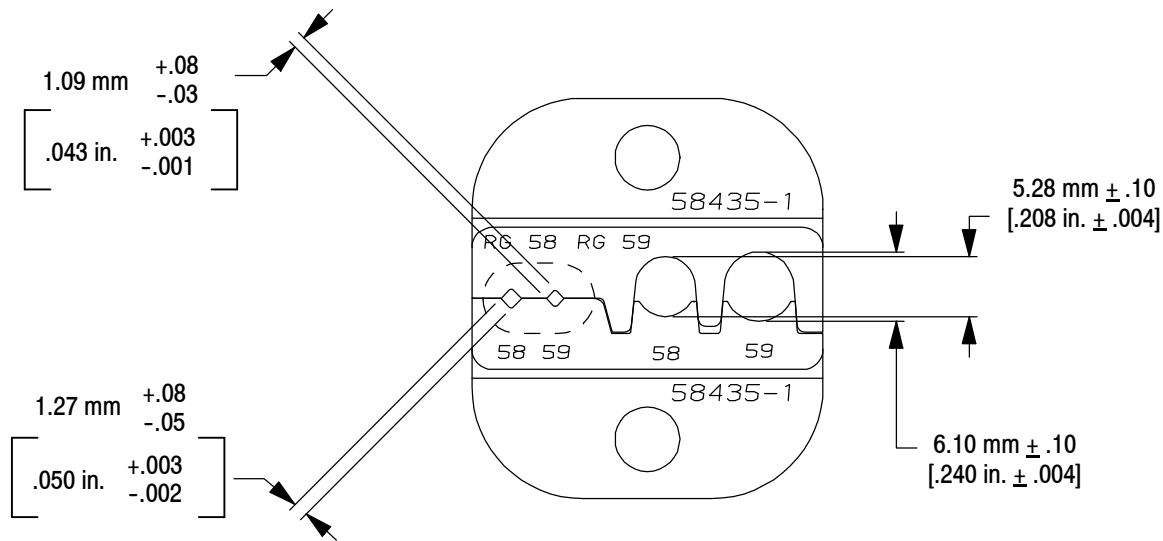

Figure 5