



Chipsmall Limited consists of a professional team with an average of over 10 year of expertise in the distribution of electronic components. Based in Hongkong, we have already established firm and mutual-benefit business relationships with customers from,Europe,America and south Asia,supplying obsolete and hard-to-find components to meet their specific needs.

With the principle of “Quality Parts,Customers Priority,Honest Operation,and Considerate Service”,our business mainly focus on the distribution of electronic components. Line cards we deal with include Microchip,ALPS,ROHM,Xilinx,Pulse,ON,Everlight and Freescale. Main products comprise IC,Modules,Potentiometer,IC Socket,Relay,Connector.Our parts cover such applications as commercial,industrial, and automotives areas.

We are looking forward to setting up business relationship with you and hope to provide you with the best service and solution. Let us make a better world for our industry!



## Contact us

Tel: +86-755-8981 8866 Fax: +86-755-8427 6832

Email & Skype: info@chipsmall.com Web: www.chipsmall.com

Address: A1208, Overseas Decoration Building, #122 Zhenhua RD., Futian, Shenzhen, China



# 59021 Aluminium Miniature Firecracker Reed Sensor + 57020 Actuator

RoHS



## Description

The 59021 Firecracker Reed Sensor is a miniature cylindrical reed sensor with a robust aluminium body 15.24mm x 5.10mm (0.600" x 0.201") with a normally open contact. It is capable of switching up to 170Vdc at 10W. It has a variety of cable lengths and connector options. It functions best with the 57020-000 actuator.

**Note: The 57020 Actuator is sold separately.**

## Features

- Two-part magnetically operated proximity sensor
- Aluminium body
- Normally open contact
- Customer defined sensitivity option
- Choice of cable length and connector

## Dimensions

Dimensions in mm (inch)

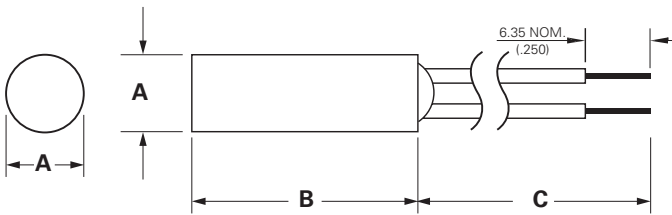

	<b>A Max.</b>	<b>B Max.</b>	<b>C Nom.</b>
<b>57020 Actuator</b>	5.10 (.201)	15.24 (.600)	--
<b>59021 Sensor</b>	5.10 (.201)	15.24 (.600)	300±10.00 (11.81±.393)

## Benefits

- Hermetically sealed, magnetically operated contacts continue to operate long after optical and other technologies fail due to contamination
- Quick and easy to install
- No standby power requirement
- Operates through non-ferrous materials such as wood, plastic or aluminium

## Applications

- Position and Limit Sensing
- Security Systems
- Level Sensing
- Linear Actuators

# 59021 Aluminium Miniature Firecracker Reed Sensor + 57020 Actuator

## Electrical Ratings

Contact Type			Normally Open
Switch Type			1
Contact Rating <sup>1</sup>		VA/Watt - max.	10
Voltage <sup>4</sup>	Switching <sup>2</sup>	Vdc - max.	170
	Breakdown <sup>3</sup>	Vdc - min.	175
Current <sup>4</sup>	Switching <sup>2</sup>	Adc - max.	0.25
	Carry	Adc - max.	0.5
Resistance <sup>5</sup>	Contact, Initial	Ω - max.	0.2
	Insulation	Ω - min.	10 <sup>10</sup>
Capacitance	Contact	pF - typ.	0.2
Temperature	Operating	°C	-40 to +105

## Product Characteristics

Operate Time <sup>6</sup>		ms - max.	1.0
Release Time <sup>6</sup>		ms - max.	1.0
Shock <sup>7</sup>	11ms ½ sine	G - max.	100
Vibration <sup>7</sup>	50-2000 Hz	G - max.	30

**Notes:**

- Contact rating - Product of the switching voltage and current should never exceed the wattage rating. Contact Littelfuse for additional load/life information.
- When switching inductive and/or capacitive loads, the effects of transient voltages and/or currents should be considered. Refer to Application Notes AN108A and AN107 for details.
- Breakdown Voltage - per MIL-STD-202, Method 301.
- Electrical Load Life Expectancy - Contact Littelfuse with voltage, current values along with type of load.
- This resistance value is for 11.81mm wire length. Resistance changes when wire lengthens.
- Operate (including bounce)/Release Time - per EIA/NARM RS-421-A, diode suppressed coil (Coil II).
- Shock and Vibration - per EIA/NARM RS-421-A and MIL-STD-202.
- For custom modifications to the wire length or size, or adding a special connector, please contact Littelfuse.

## Sensitivity Options (Using 57020 Actuator)

Select Option		S	
Switch Type		Pull-In AT Range	Activate Distance – D mm (inch) Average
1	Normally Open	6-10	6.0 (.236)

**Note:**

- Pull-In AT Range: These AT values are the bare reed switch AT before modification.
- The activation distance is average value on the final sensor assembly.

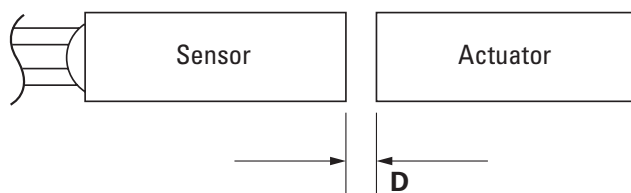

# 59021 Aluminium Miniature Firecracker Reed Sensor + 57020 Actuator

## Cable Length Specification

Cable Type: 26 AWG 7/34 PVC 105°C UL1430/UL1569	
Select Option	Cable Length mm (inch)
02	300 (11.81)

## Termination Specification

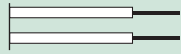
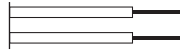
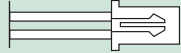
Termination Options		
Select Option	Description (Two-wire versions illustrated)	
A	Tinned leads (6.4±0.76)mm	
F	Untinned leads (6.4±0.76)mm	
E	JST type XHP 2.5mm pitch	

## Part Numbering System

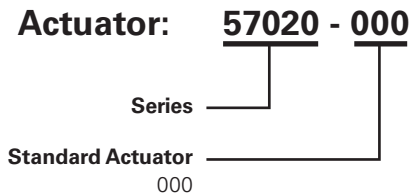
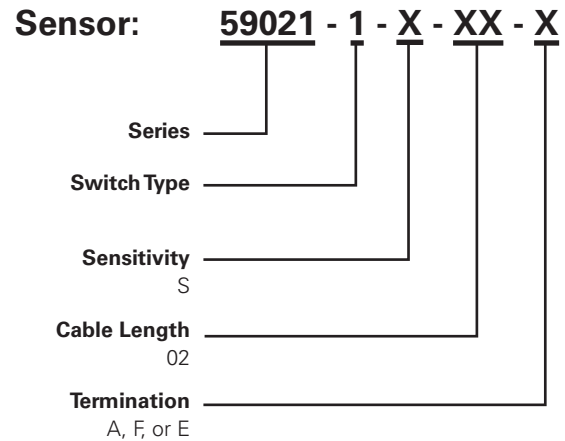

**Note:**  
The 57020 Actuator is sold separately.

## Packaging

Packaging Option	Packaging Specification	Quantity	Quantity & Packaging Code	Taping Width
Bulk	Bulk	500	N/A	N/A