



Chipsmall Limited consists of a professional team with an average of over 10 year of expertise in the distribution of electronic components. Based in Hongkong, we have already established firm and mutual-benefit business relationships with customers from,Europe,America and south Asia,supplying obsolete and hard-to-find components to meet their specific needs.

With the principle of "Quality Parts,Customers Priority,Honest Operation,and Considerate Service",our business mainly focus on the distribution of electronic components. Line cards we deal with include Microchip,ALPS,ROHM,Xilinx,Pulse,ON,Everlight and Freescale. Main products comprise IC,Modules,Potentiometer,IC Socket,Relay,Connector.Our parts cover such applications as commercial,industrial, and automotives areas.

We are looking forward to setting up business relationship with you and hope to provide you with the best service and solution. Let us make a better world for our industry!



Contact us

Tel: +86-755-8981 8866 Fax: +86-755-8427 6832

Email & Skype: info@chipsmall.com Web: www.chipsmall.com

Address: A1208, Overseas Decoration Building, #122 Zhenhua RD., Futian, Shenzhen, China



59025 Firecracker Reed Sensor + 57025 Actuator



Description

The 59025 Firecracker Reed Sensor is a small cylindrical reed sensor, 25.4mm (L) x 6.22mm (Dia.) (1.00" x 0.245"), with a choice of normally open, normally closed or change-over contacts. It is capable of switching up to 265Vac/300Vdc at 10VA. The 59025 Firecracker Reed Sensor is available with a range of sensitivity and cable length options. It functions best with the 57025 actuator.

Note: The 57025 Actuator is sold separately.

Features

- Magnetically-operated proximity sensor
- Hermetically sealed contacts
- Operates through non-ferrous materials such as wood, plastic or aluminum
- Customer-defined sensitivity option
- Custom cable length and connector options available

Agency Approvals

Agency	Agency File Number
	E61760

Note: Contact Littelfuse for specific agency approval ratings.

Dimensions

Dimensions in mm (inch)

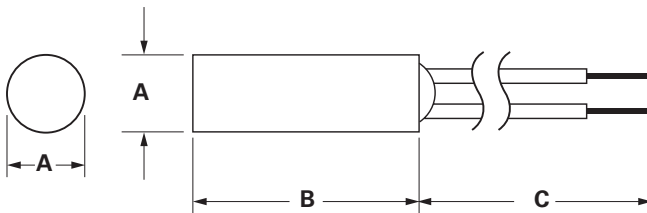

	A Nom.	B Nom.	C Nom.
57025 Actuator	6.22 (.245)	25.40 (1.000)	--
59025 Sensor	6.22 (.245)	25.40 (1.000)	Cable Length ± 10.00 (.393)

Benefits

- Fits nicely into small confined spaces
- Quick and easy to install
- Well suited for usage in high-moisture and contaminated environments
- Non-contact solution, aesthetically more appealing than push-button or lever mechanical-type switches
- Ideal for battery-powered applications as the contacts do not draw power when in the non-activated state
- Reed contacts last for millions of operating cycles under micro-controller logic level loads

Applications

- Position and limit sensing
- Security
- Level sensing
- Linear actuators

59025 Firecracker Reed Sensor + 57025 Actuator

Electrical Ratings

Contact Type			Normally Open	Normally Open High Voltage	Change Over	Normally Closed
Switch Type			1	2	3	4
Contact Rating ¹		VA/Watt - max.	10	10	5	5
Voltage ⁴	Switching ²	Vdc - max.	200	300	175	175
	Breakdown ³	Vac - max.	140	265	120	120
		Vdc - min.	250	400	200	200
Current ⁴	Switching ²	Adc - max.	0.5	0.4	0.25	0.25
	Carry	Aac - max.	0.35	0.30	0.18	0.18
		Adc - max.	1.2	1.4	1.5	1.5
Resistance ⁵	Contact, Initial Insulation	Ω - max. Ω - min.	0.2 10 ¹⁰	0.2 10 ¹⁰	0.2 10 ⁹	0.2 10 ⁹
Capacitance	Contact	pF - typ.	0.3	0.2	0.3	0.3
Temperature	Operating	°C	-40 to +105	-20 to +105	-40 to +105	-40 to +105

Product Characteristics

Operate Time ⁶		ms - max.	1.0		3.0	3.0
Release Time ⁶		ms - max.	1.0		3.0	3.0
Shock ⁷	11ms ½ sine	G - max.	100		50	50
Vibration ⁷	50-2000 Hz	G - max.	30		30	30

Notes:

- Contact rating - Product of the switching voltage and current should never exceed the wattage rating. Contact Littelfuse for additional load/life information.
- When switching inductive and/or capacitive loads, the effects of transient voltages and/or currents should be considered. Refer to Application Notes AN108A and AN107 for details.
- Breakdown Voltage - per MIL-STD-202, Method 301. Leakage current is less than 0.1mA for 60 seconds.
- Electrical Load Life Expectancy - Contact Littelfuse with voltage, current values along with type of load.
- This resistance value is for 11.81mm wire length. Resistance changes when wire lengthens.
- Operate (including bounce)/Release Time - per EIA/NARM RS-421-A, diode suppressed coil (Coil II).
- Shock and Vibration - per EIA/NARM RS-421-A and MIL-STD-202.
- For custom modifications to the wire length or size, or adding a special connector, please contact Littelfuse.
- Custom sensitivities and a high voltage switch are options



Sensitivity Options (Using 57025 Actuator)

Select Option	Switch Type	S		T		U		V	
		Pull-In AT Range	Activate Distance mm (inch) Average	Pull-In AT Range	Activate Distance mm (inch) Average	Pull-In AT Range	Activate Distance mm (inch) Average	Pull-In AT Range	Activate Distance mm (inch) Average
1	Normally Open	12-18	7.9 (.311)	17-23	6.2 (.244)	22-28	4.9 (.193)	27-33	4.2 (.165)
2	High Voltage	--	--	17-23	6.2 (.244)	22-28	4.9 (.193)	27-33	4.2 (.165)
3	Change Over	15-20	7.2 (.283)	20-25	5.7 (.224)	25-30	4.7 (.185)	--	--
4	Normally Closed	15-20	7.2 (.283)	20-25	5.7 (.224)	25-30	4.7 (.185)	--	--

Note:

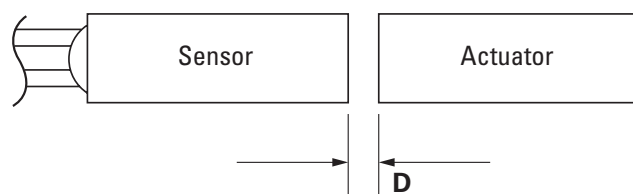
- Pull-In AT Range: These AT values are the bare reed switch AT before modification.
- The activation distance is average value on the final sensor assembly.

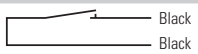



Schematics	Switch Type
	1
	3
	4

59025 Firecracker Reed Sensor + 57025 Actuator

Cable Length Specification

Cable Type: 24 AWG 7/32 PVC 105°C UL1430/UL1569	
Select Option	Cable Length mm (inch)
02	300 (11.81)

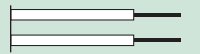
Termination Specification

Termination Options		
Select Option	Description (Two-wire versions illustrated)	
A	Tinned leads (6.4±0.76)mm	
F	Untinned leads (6.4±0.76)mm	
E	JST type XHP 2.5mm pitch	

Part Numbering System

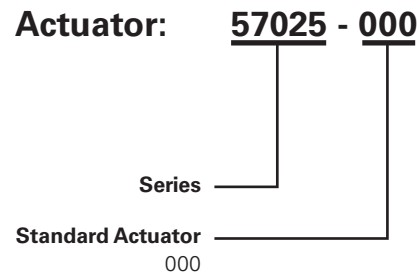
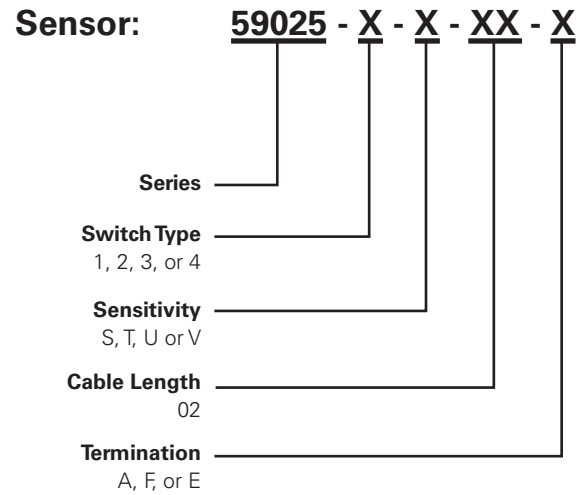

Note: The 57025 Actuator is sold separately.

Packaging

Packaging Option	Packaging Specification	Quantity	Quantity & Packaging Code	Taping Width
Bulk	Bulk	500	N/A	N/A