



Chipsmall Limited consists of a professional team with an average of over 10 year of expertise in the distribution of electronic components. Based in Hongkong, we have already established firm and mutual-benefit business relationships with customers from,Europe,America and south Asia,supplying obsolete and hard-to-find components to meet their specific needs.

With the principle of “Quality Parts,Customers Priority,Honest Operation,and Considerate Service”,our business mainly focus on the distribution of electronic components. Line cards we deal with include Microchip,ALPS,ROHM,Xilinx,Pulse,ON,Everlight and Freescale. Main products comprise IC,Modules,Potentiometer,IC Socket,Relay,Connector.Our parts cover such applications as commercial,industrial, and automotives areas.

We are looking forward to setting up business relationship with you and hope to provide you with the best service and solution. Let us make a better world for our industry!



Contact us

Tel: +86-755-8981 8866 Fax: +86-755-8427 6832

Email & Skype: info@chipsmall.com Web: www.chipsmall.com

Address: A1208, Overseas Decoration Building, #122 Zhenhua RD., Futian, Shenzhen, China



59060 Stainless Steel M8 Threaded Barrel Sensor + 57060 Actuator

RoHS



Dimensions

Dimensions in mm (inch)

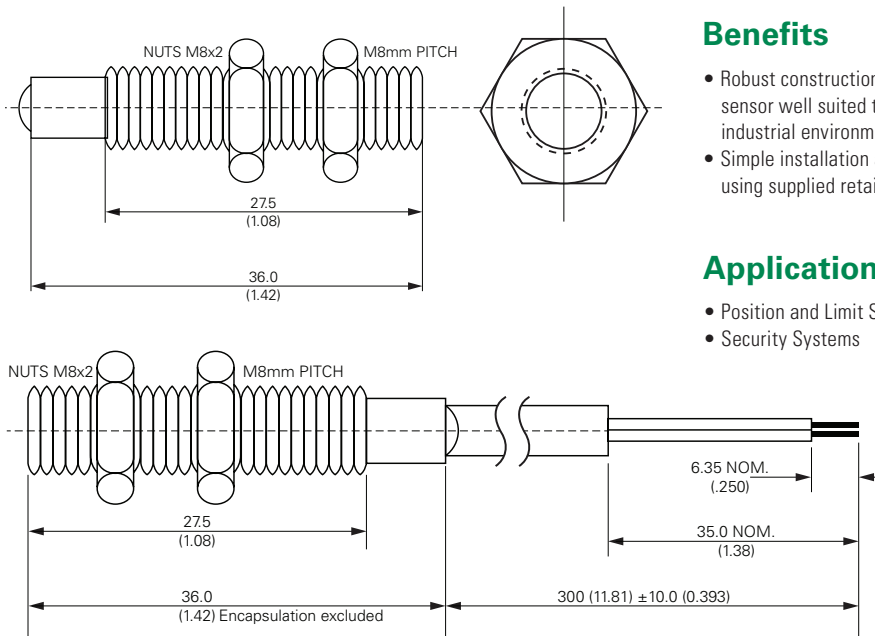

Description

The 59060 is a small stainless steel barrel sensor with an M8 x 1.25mm pitch thread, 36mm (1.420") long with a choice of normally open, normally open high voltage, normally closed or change over contacts. It is capable of switching up to 265Vac/300Vdc at 10VA. It has a variety range of sensitivity, cable length and connector options. It functions best with the 57060 actuator.

Note: The 57060 Actuator is sold separately.

Features

- Two-part magnetically operated proximity sensor
- Stainless steel threaded barrel with retaining nuts
- M8 thread
- Choice of normally open or normal open high voltage contacts
- Customer defined sensitivity options
- Choice of cable length and

Benefits

- Robust construction makes this sensor well suited to harsh industrial environments
- Simple installation and adjustment using supplied retaining nuts
- No standby power requirement
- Operates through non-ferrous materials such as wood, plastic or aluminium

Applications

- Position and Limit Sensing
- Security Systems
- Industrial Process Control
- Linear Actuators

59060 Stainless Steel M8 Threaded Barrel Sensor + 57060 Actuator

Electrical Ratings

Contact Type			Normally Open	Normally Open High Voltage	Change Over	Normally Closed
Switch Type			1	2	3	4
Contact Rating ¹		VA/Watt - max.	10	10	5	5
Voltage ⁴	Switching ²	Vdc - max.	200	300	175	175
		Vac - max.	140	265	120	120
	Breakdown ³	Vdc - min.	250	450	200	200
Current ⁴	Switching ²	Adc - max.	0.5	0.5	0.25	0.25
		Aac - max.	0.35	0.35	1.0	1.0
	Carry	Adc - max.	1.2	1.5	1.5	1.5
Resistance ⁵	Contact, Initial Insulation	Ω - max.	0.2	0.2	0.2	0.2
		Ω - min.	10 ¹⁰	10 ¹⁰	10 ⁹	10 ⁹
Capacitance	Contact	pF - typ.	0.3	0.2	0.3	0.3
Temperature	Operating Storage	°C	-40 to +105	-20 to +105	-40 to +105	-40 to +105
		°C	-65 to +105	-65 to +105	-65 to +105	-65 to +105

Product Characteristics

Operate Time ⁶		ms - max.	1.0	1.0	3.0	3.0
Release Time ⁶		ms - max.	1.0	1.0	3.0	3.0
Shock ⁷	11ms ½ sine	G - max.	100	100	50	50
Vibration ⁷	50-2000 Hz	G - max.	30	30	30	30

Notes:

- Contact rating - Product of the switching voltage and current should never exceed the wattage rating. Contact Littelfuse for additional load/life information.
- When switching inductive and/or capacitive loads, the effects of transient voltages and/or currents should be considered. Refer to Application Notes AN108A and AN107 for details.
- Breakdown Voltage - per MIL-STD-202, Method 301.
- Electrical Load Life Expectancy - Contact Littelfuse with voltage, current values along with type of load.
- This resistance value is for 11.81mm wire length. Resistance changes when wire lengthens.
- Operate (including bounce)/Release Time - per EIA/NARM RS-421-A, diode suppressed coil (Coil II).
- Shock and Vibration - per EIA/NARM RS-421-A and MIL-STD-202.
- For custom modifications to the wire length or size, or adding a special connector, please contact Littelfuse.

Sensitivity Options (Using 57060 Actuator)

Select Option		S		T		U		V	
Switch Type	Pull-In AT Range	Activate Distance - D mm (inch) Minimum	Pull-In AT Range	Activate Distance - D mm (inch) Minimum	Pull-In AT Range	Activate Distance - D mm (inch) Minimum	Pull-In AT Range	Activate Distance - D mm (inch) Minimum	
1 Normally Open	12-18	12.0 (.472)	17-23	9.0 (.354)	22-28	7.0 (.276)	27-33	5.5 (.217)	
2 High Voltage	--	--	17-23	9.0 (.354)	22-28	7.0 (.276)	27-33	5.5 (.217)	
3 Change Over	15-20	12.0 (.472)	20-25	7.5 (.295)	25-30	6.0 (.236)	--	--	
4 Normally Closed	15-20	12.0 (.472)	20-25	7.5 (.295)	25-30	6.0 (.236)	--	--	

Note:

- Pull-In AT Range: These AT values are the bare reed switch AT before modification.
- The activation distance is average value on the final sensor assembly.

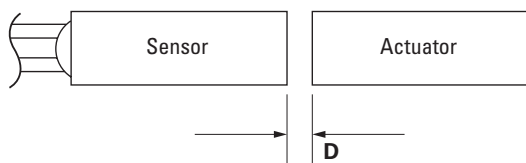



Schematics	Switch Type
	1 and 2
	3
	4

59060 Stainless Steel M8 Threaded Barrel Sensor + 57060 Actuator

Cable Length Options

Cable Type: 24 AWG 7/32 PVC 105°C DOUBLE INSULATED	
Select Option	Cable Length mm (inch)
02	300 (11.81)

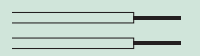
Termination Specification

Termination Options		
Select Option	Description (Two-wire versions illustrated)	
A	Tinned leads (6.4±0.76)mm	
F	Untinned leads (6.4±0.76)mm	
E	JST type XHP 2.5mm pitch	

Part Numbering System

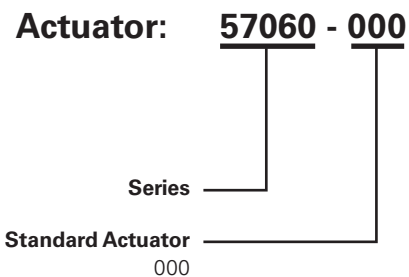
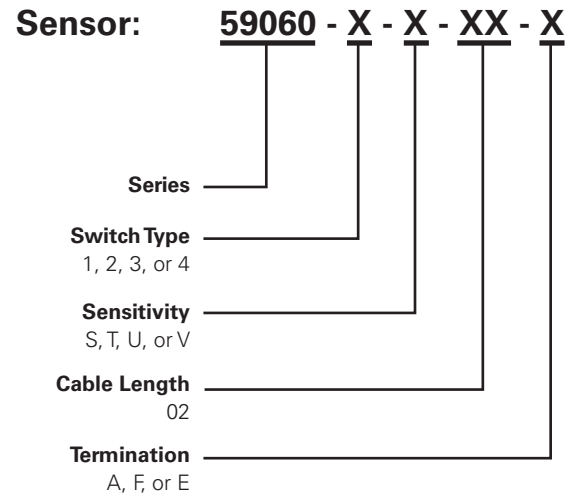

Note: The 57060 Actuator is sold separately.

Packaging

Packaging Option	Packaging Specification	Quantity	Quantity & Packaging Code	Taping Width
Bulk	Bulk	500	N/A	N/A