



Chipsmall Limited consists of a professional team with an average of over 10 year of expertise in the distribution of electronic components. Based in Hongkong, we have already established firm and mutual-benefit business relationships with customers from,Europe,America and south Asia,supplying obsolete and hard-to-find components to meet their specific needs.

With the principle of "Quality Parts,Customers Priority,Honest Operation,and Considerate Service",our business mainly focus on the distribution of electronic components. Line cards we deal with include Microchip,ALPS,ROHM,Xilinx,Pulse,ON,Everlight and Freescale. Main products comprise IC,Modules,Potentiometer,IC Socket,Relay,Connector.Our parts cover such applications as commercial,industrial, and automotives areas.

We are looking forward to setting up business relationship with you and hope to provide you with the best service and solution. Let us make a better world for our industry!



Contact us

Tel: +86-755-8981 8866 Fax: +86-755-8427 6832

Email & Skype: info@chipsmall.com Web: www.chipsmall.com

Address: A1208, Overseas Decoration Building, #122 Zhenhua RD., Futian, Shenzhen, China



Dialight

Micro LED® SMD LED “598 SERIES” 1206 PACKAGE (3.2mm X 1.6mm X 0.7mm) Single Color Diffused

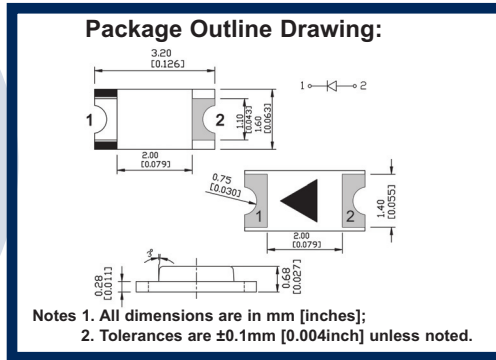
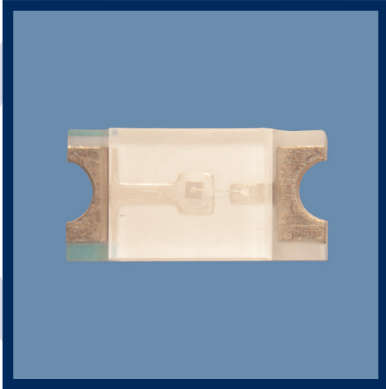

- ### FEATURES / BENEFITS
- ▲ Compatible with automatic placement equipment
 - ▲ RoHS compliant
 - ▲ Packaged in 8mm tape, 7" reel and 20 per strip
 - ▲ Meets EIA-481-1 pkg. std.

ORDERING INFORMATION

5 9 8 - 9 2 1 0 - 1 0 7 F	
Packaging Option	
2	20 pieces on tape
7	7" reel 3000pcs / reel

PART NUMBERS

DIALIGHT P/N	EMITTED COLOR	MATERIAL	LENS COLOR	LUMINOUS INTENSITY If = 20 ma			DOMINANT WAVELENGTH If = 20 ma			FORWARD VOLTAGE If = 20 ma			VIEWING ANGLE ° DEGREES
				MIN	TYP	MAX	MIN	TYP	MAX	MIN	TYP	MAX	
598-9210-107F	RED	AllnGaP	Diffused	30	-	80	630	635	640	1.7	2	2.4	140
598-9220-107F	RED-ORANGE	AllnGaP	Diffused	120	150	200	620	625	630	1.7	2	2.4	140
598-9230-107F	ORANGE	AllnGaP	Diffused	70	-	150	600	-	610	1.7	2	2.4	140
598-9250-107F	YELLOW	AllnGaP	Diffused	100	130	160	583	-	590	1.7	2	2.4	140
598-9260-107F	YELLOW-GREEN	AllnGaP	Diffused	20	40	60	570	-	575	1.8	2	2.4	140
598-9270-107F	GREEN	GaP	Diffused	10	20	40	562	-	570	1.8	2	2.4	140
598-9280-107F	GREEN	InGaN	Diffused	150	220	300	520	523	525	3	3.2	3.5	140
598-9281-107F	GREEN	InGaN	Diffused	220	300	400	520	523	525	3	3.2	3.5	140
598-9290-107F	BLUE	InGaN	Diffused	60	90	140	470	473	475	2.8	3.2	3.5	140
598-9291-107F	BLUE	InGaN	Diffused	90	140	160	470	473	475	2.8	3.2	3.5	140

ABSOLUTE RATINGS (@ Ta = 25°C)

DIALIGHT P/N	Power Dissipation	Forward Current	Reverse Voltage	Operating Temperature Range	Storage Temperature Range	Peak Pulse Forward Current	Electrostatic Discharge
	(mW)	(mA)	(V)	(°C)	(°C)	(mA)	(HBM)
598-9210-107F	60	25	5	-30~+85	-40~+100	100	2000
598-9220-107F	60	25	5	-30~+85	-40~+100	100	2000
598-9230-107F	60	25	5	-30~+100	-40~+100	100	2000
598-9250-107F	55	25	5	-30~+85	-40~+100	100	1000
598-9260-107F	72	30	5	-20~+85	-30~+100	100	2000
598-9270-107F	60	25	5	-30~+85	-40~+100	100	1000
598-9280-107F	87.5	25	5	-30~+85	-40~+100	100	1000
598-9281-107F	87.5	25	5	-30~+85	-40~+100	100	1000
598-9290-107F	87.5	25	5	-30~+85	-40~+100	100	1000
598-9291-107F	87.5	25	5	-30~+85	-40~+100	100	2000



Dialight Corporation

1501 Route 34 South • Farmingdale, NJ 07727 USA

Tel: (1) 732-919-3119 • Fax: (1) 732-751-5778 • www.dialight.com



MDEI5981206DF_A

MECHANICAL DIMENSIONS

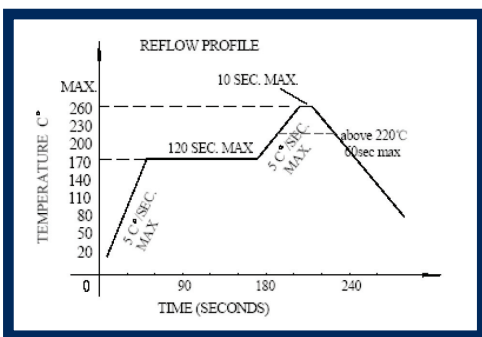
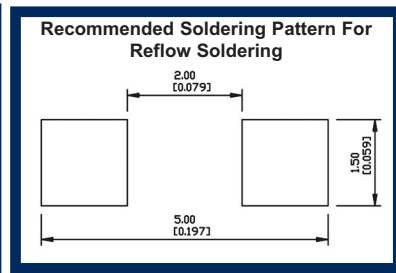
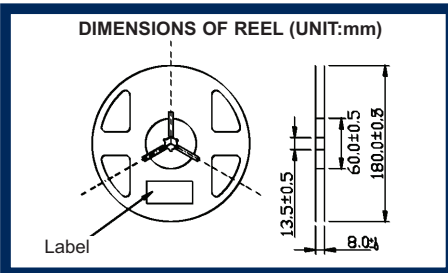
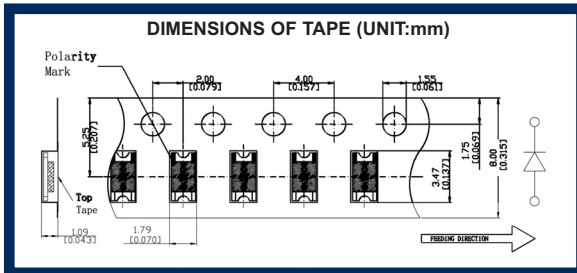

	REFLOW SOLDERING	HAND SOLDERING
Pre-heat	160~180°C	Temperature 300°C Max.
Pre-heat time	120 seconds Max.	
Peak temperature	260°C Max.	Soldering time 3 second Max (one time only)
Soldering time	10 seconds Max.	
Condition	Refer to temperature profile	

OPTICAL AND ELECTRICAL CHARACTERISTICS CURVES

RED 630-642NM, RED-ORANGE 620-630NM, ORANGE 600-610NM, YELLOW 590-595NM, YELLOW 583-590NM, YELLOW GREEN 570-575NM, GREEN 562-570NM

FORWARD VOLTAGE VS FORWARD CURRENT (Ta=25°C)

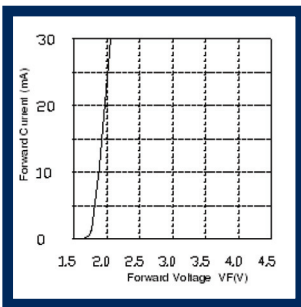

RELATIVE INTENSITY VS FORWARD CURRENT (Ta=25°C)

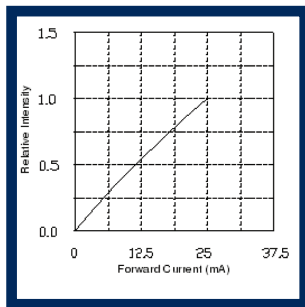

DERATING

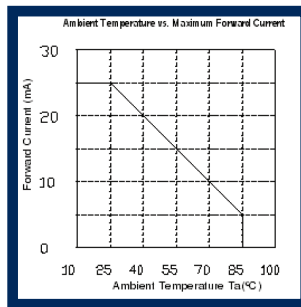

RELATIVE INTENSITY VS AMBIENT TEMPERATURE

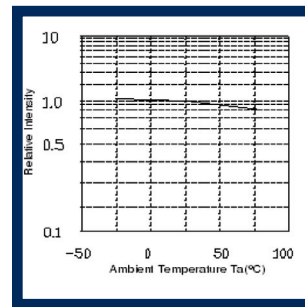

GREEN 520-525NM, BLUE 470-475NM

FORWARD VOLTAGE VS FORWARD CURRENT (Ta=25°C)

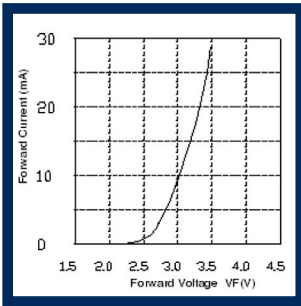

RELATIVE INTENSITY VS FORWARD CURRENT (Ta=25°C)

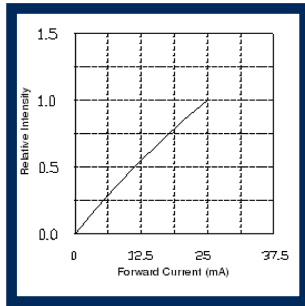

DERATING

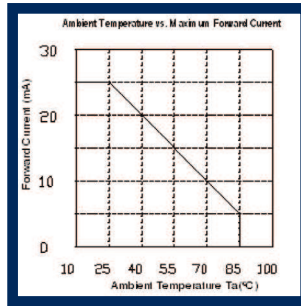

RELATIVE INTENSITY VS AMBIENT TEMPERATURE

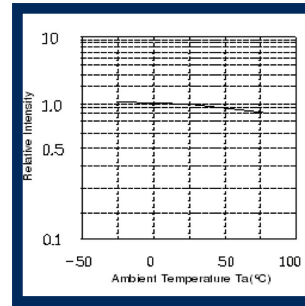

A4703



ISO 9001

Dialight Corporation



Dialight Corporation

1501 Route 34 South • Farmingdale, NJ 07727 USA

Tel: (1) 732-919-3119 • Fax: (1) 732-751-5778 • www.dialight.com



MDEI5981206DF_A