



Chipsmall Limited consists of a professional team with an average of over 10 year of expertise in the distribution of electronic components. Based in Hongkong, we have already established firm and mutual-benefit business relationships with customers from,Europe,America and south Asia,supplying obsolete and hard-to-find components to meet their specific needs.

With the principle of "Quality Parts,Customers Priority,Honest Operation,and Considerate Service",our business mainly focus on the distribution of electronic components. Line cards we deal with include Microchip,ALPS,ROHM,Xilinx,Pulse,ON,Everlight and Freescale. Main products comprise IC,Modules,Potentiometer,IC Socket,Relay,Connector.Our parts cover such applications as commercial,industrial, and automotives areas.

We are looking forward to setting up business relationship with you and hope to provide you with the best service and solution. Let us make a better world for our industry!



## Contact us

Tel: +86-755-8981 8866 Fax: +86-755-8427 6832

Email & Skype: info@chipsmall.com Web: www.chipsmall.com

Address: A1208, Overseas Decoration Building, #122 Zhenhua RD., Futian, Shenzhen, China



# Type 5ET / 5ETP

## Time-Lag Fuse Series (High Surge-proof, Enhanced-Breaking Capacity)

**HF** **Pb** 5ET/5ETP Series, 5x20mm Glass Tube Time-lag Fuse

RoHS 6 Compliant

### Description

5x20mm Time lag fuse, high surge-proof, enhanced breaking capacity, glass tube body cartridge fuse designed, approved and complied with IEC 60127-2, standard sheet 6.

### Features

- Meet IEC standard 60127-2, sheet 6
- Wide operating temperature range
- Bulk and Tape & Reel packing available
- RoHS 6 compliant
- Halogen Free
- Leadfree

### Applications

Provide individual protection for components or internal circuits.

- Power supplies
- Battery charger
- Monitor
- Adapter

LEAD FREE = **Pb**  
HALOGEN FREE = **HF**

### Physical Specifications

Materials	Body : Glass
	Cap : Nickel Plated Brass Caps
	Leads : Matte Tin Plated Copper
Marking	On Fuse :
	"bel", "T", "Current Rating", "E", "250V",
	"Appropriate Safety Logos", "✓" (RoHS 6 compliant)
	On Label :
	"bel", "5ET" or "5ETP", "Current Rating", "Voltage Rating", "Interrupting Rating", "Appropriate Safety Logos" and "♻️", "♻️" (China RoHS compliant).

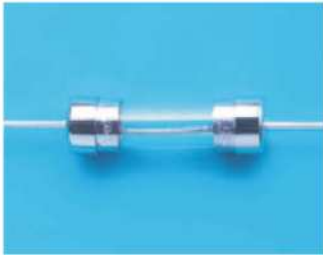

### Electrical Characteristics (IEC-127-2 STANDARD SHEET 6)

Rated Current	1.5 In		2.1 In		2.75 In		4 In		10 In	
	MIN	MAX	MIN	MAX	MIN	MAX	MIN	MAX	MIN	MAX
1A to 12A	1 hr.	2 min.	600 ms	10 sec	150 ms	3 sec	20 ms	300 ms		

In clause 9.2, the test voltage for 5ETP ratings from 1A to 6.3A is 63VDC.

### Safety Agency Approvals

SAFETY AGENCY	SAFETY AGENCY CERTIFICATE NUMBER	VOLTAGE RATING (V)	AMPERE RANGE / VOLT @ I.R. ABILITY*
	1216132 1400794	1A - 12A / 250V AC	1A - 6.3A / 250V AC @ 150A 8A - 12A / 250V AC @ 150A
	40007746		
	E20624		
	LR39772		
	2003010207030342		

\* I.R. = INTERRUPTING RATING = SHORT CIRCUIT RATING (AMPS)

Specifications subject to change without notice



Bel Fuse Inc.  
206 Van Vorst Street  
Jersey City, NJ 07302 USA

+1 201.432.0463  
techhelp@belf.com  
[belfuse.com](http://belfuse.com)

# Type 5ET / 5ETP

## Time-Lag Fuse Series (High Surge-proof, Enhanced-Breaking Capacity)





HF  5ET/5ETP Series, 5x20mm Glass Tube Time-lag Fuse

RoHS 6 Compliant

### Environmental Specifications

Shock Resistance	MIL-STD-202G, Method 213B, Test Condition 1 (100 G's peak for 6 milliseconds; Sawtooth waveform)
Vibration Resistance	MIL-STD-202G, Method 201A(10-55 Hz, 0.06 inch, total excursion).
Salt Spray Resistance	MIL-STD-202G, Method 101E, Test Condition B(48 hrs).
Insulation Resistance	MIL-STD-202G, Method 302, Test Condition B (After Opening) 100, 000 ohms minimum.
Solderability	MIL-STD-202G, Method 208H
Resistance to solder Heat	MIL-STD-202G, Method 210F, Test Condition B.(260+/-5 °C,10+/-1 sec)
Thermal Shock	MIL-STD-202G, Method 107G, Test Condition B (-65 °C to +125 °C).
Operating Temperature	-55 °C to +125 °C
Terminal Strength	IEC-68-2-21

### Electrical Specifications

Catalog Number	Ampere Rating	Typical Cold Resistance (ohm)	Volt-drop @100% In (Volt) max.	Voltage and Interrupting Ratings	Melting I <sup>2</sup> T <10 mSec (A <sup>2</sup> Sec)	Melting I <sup>2</sup> T @10 In (A <sup>2</sup> Sec)	Maximum Power Dissipation (W)	Agency Approvals				
												
5ET (P) 1-R	1A	0.111	0.15	See Table of Safety Approvals on Page 1 for Voltage and associated Interrupting Ratings	28	29	0.42	Y	Y	Y	Y	Y
5ET (P) 1.25-R	1.25A	0.073	0.13		42	43	0.42	Y	Y	Y	Y	Y
5ET (P) 1.6-R	1.6A	0.058	0.13		62	64	0.51	Y	Y	Y	Y	Y
5ET (P) 2-R	2A	0.039	0.12		92	95	0.61	Y	Y	Y	Y	Y
5ET (P) 2.5-R	2.5A	0.031	0.12		137	142	0.74	Y	Y	Y	Y	Y
5ET (P) 3.15-R	3.15A	0.023	0.10		203	211	0.90	Y	Y	Y	Y	Y
5ET (P) 4-R	4A	0.017	0.10		300	313	1.08	Y	Y	Y	Y	Y
5ET (P) 5-R	5A	0.012	0.09		444	465	1.31	Y	Y	Y	Y	Y
5ET (P) 6.3-R	6.3A	0.010	0.09		658	691	1.58	Y	Y	Y	Y	Y
5ET (P) 8-R	8A	0.007	0.09		252	277	3.11				Y	
5ET (P) 10-R	10A	0.006	0.08		400	440	3.68				Y	
5ET (P) 12-R	12A	0.005	0.08		635	699	4.36				Y	

Consult manufacturer for other ratings

Specifications subject to change without notice



Bel Fuse Inc.  
206 Van Vorst Street  
Jersey City, NJ 07302 USA

+1 201.432.0463  
techhelp@belf.com  
[belfuse.com](http://belfuse.com)

# Type 5ET / 5ETP

Time-Lag Fuse Series (High Surge-proof, Enhanced-Breaking Capacity)

HF  5ET/5ETP Series, 5x20mm Glass Tube Time-lag Fuse

RoHS 6 Compliant

## Average Time Current Curve

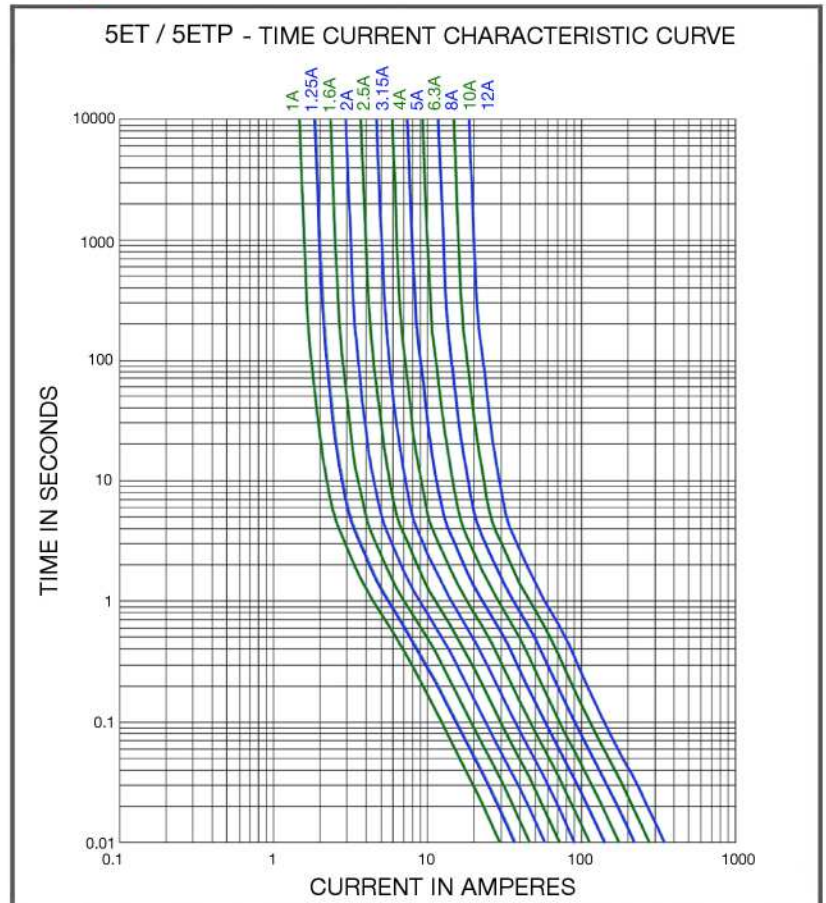

## Temperature Derating Curve

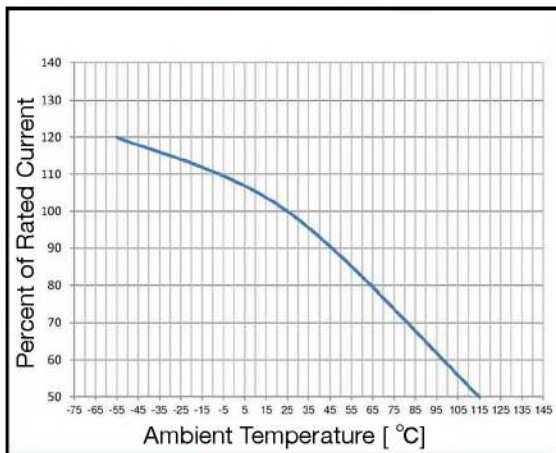

## Soldering Parameters

Lead-free Wave Soldering Profile	
Wave Soldering Parameter	
Average ramp-up rate	200 °C / second
Heating rate during preheat	typical 1 - 2 °C / second Max 4 °C / second
Final preheat temperature	within 125 °C of soldering temperature
Peak temperature T <sub>p</sub>	260 °C
Time within +0 °C / -5 °C of actual peak temperature	10 seconds
Ramp-down rate	5 °C / second max.

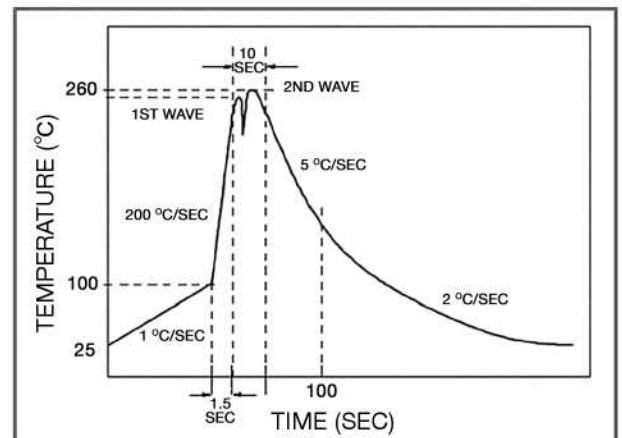

Specifications subject to change without notice



Bel Fuse Inc.  
206 Van Vorst Street  
Jersey City, NJ 07302 USA

+1 201.432.0463  
techhelp@belf.com  
[belfuse.com](http://belfuse.com)

# Type 5ET / 5ETP

Time-Lag Fuse Series (High Surge-proof, Enhanced-Breaking Capacity)

HF  5ET/5ETP Series, 5x20mm Glass Tube Time-lag Fuse

RoHS 6 Compliant

## Fuse FGNO Explanation

0655 R [XXXX] - XX

0655R=5ET/5ETP; [XXXX]=Ampere Rating; XX=See Ordering Information as below

Fraction	Decimal	Amps	Bel FGNO[XXXX]
	1.0	1	1000
1-1/4	1.25	1.25	1250
	1.60	1.6	1600
	2.0	2	2000
2-1/2	2.5	2.5	2500
	3.15	3.15	3150
	4.0	4	4000
	5.0	5	5000
	6.3	6.3	6300
	8.0	8	8000
		10	9100
		12	9120

## Mechanical Dimensions

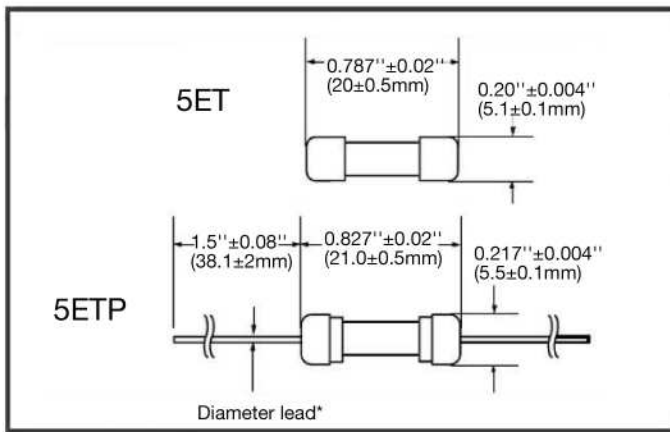

\*Ratings 6.3A and less have 0.032" diameter lead

\*Ratings 8A and above have 0.040" diameter lead

## Ordering Information

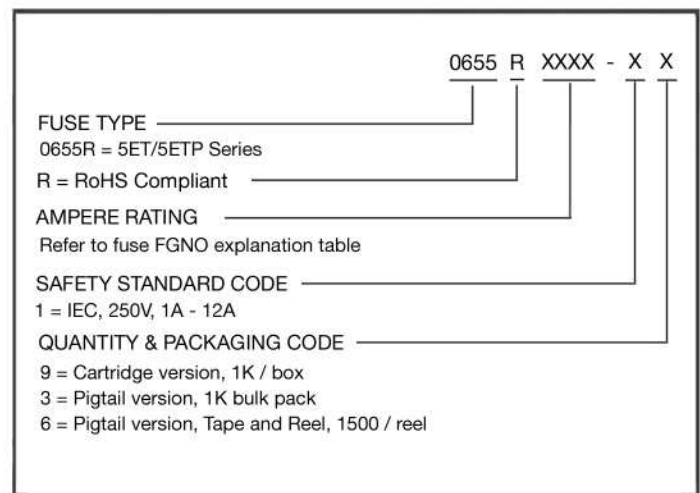

## Packaging

Packaging Option	Packaging Specification	Quantity	Packaging Code	Inside Tape Spacing
Bulk	N/A	1000	19	N/A
Bulk ( Pigtail Type )	N/A	1000	13	N/A
Tape & Reel, 10 mm Pitch	EIA-296-F	1500	16	63

Specifications subject to change without notice



Bel Fuse Inc.  
206 Van Vorst Street  
Jersey City, NJ 07302 USA

+1 201.432.0463  
techhelp@belf.com  
[belfuse.com](http://belfuse.com)