



Chipsmall Limited consists of a professional team with an average of over 10 year of expertise in the distribution of electronic components. Based in Hongkong, we have already established firm and mutual-benefit business relationships with customers from,Europe,America and south Asia,supplying obsolete and hard-to-find components to meet their specific needs.

With the principle of “Quality Parts,Customers Priority,Honest Operation,and Considerate Service”,our business mainly focus on the distribution of electronic components. Line cards we deal with include Microchip,ALPS,ROHM,Xilinx,Pulse,ON,Everlight and Freescale. Main products comprise IC,Modules,Potentiometer,IC Socket,Relay,Connector.Our parts cover such applications as commercial,industrial, and automotives areas.

We are looking forward to setting up business relationship with you and hope to provide you with the best service and solution. Let us make a better world for our industry!



Contact us

Tel: +86-755-8981 8866 Fax: +86-755-8427 6832

Email & Skype: info@chipsmall.com Web: www.chipsmall.com

Address: A1208, Overseas Decoration Building, #122 Zhenhua RD., Futian, Shenzhen, China



Type 5MT / 5MTP

Medium Blow Fuse Series

HF Pb 5MT/5MTP Series, 5x20mm Glass Tube Medium Blow Fuse

RoHS 6 Compliant

Description

5x20mm Medium Blow, glass tube body cartridge fuse designed, approved and complied with UL and CSA standard 248-14.

Features

- Meet UL and CSA standard 248-14
- Wide operating temperature range
- Bulk and Tape & Reel packing available
- RoHS 6 compliant
- Halogen Free
- Leadfree

Applications



Provide individual protection for components or internal circuits.

- Power supplies
- Battery charger
- Monitor
- Adapter

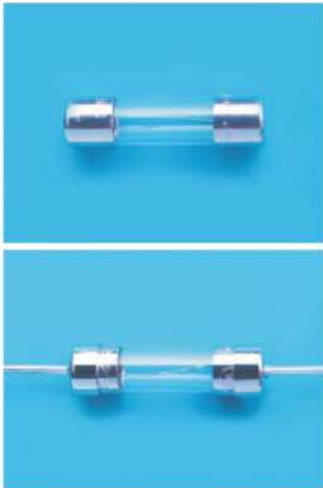
LEAD FREE = 
HALOGEN FREE = 





Physical Specifications

Materials	Body : Glass
	Cap : Nickel Plated Brass Caps
	Leads : Matte Tin Plated Copper
Marking	On Fuse :
	"bel", "5MT", "Current Rating", "Voltage Rating", "Appropriate Safety Logos", "✓" (RoHS 6 compliant)
	On Label :
	"bel", "5MT" or "5MTP", "Current Rating", "Voltage Rating", "Interrupting Rating", "Appropriate Safety Logos" and "  ", "  " (China RoHS compliant).

Electrical Characteristics (UL / CSA STD.248-14)

Testing Current	Blow Time	
	Minimum	Maximum
100%	4 Hrs.	N/A
135%	N/A	1 Hr
200%	N/A	15 sec
1000%	10 mSec	N/A

Safety Agency Approvals

SAFETY AGENCY	SAFETY AGENCY CERTIFICATE NUMBER	VOLTAGE RATING (V)	AMPERE RANGE / VOLT @ I.R. ABILITY*
	E20624	100mA - 3A / 250V AC 3.15A - 7A / 125V AC	100mA - 800mA / 250V AC @ 35A 1A - 3A / 250V AC @ 100A 100mA - 5A / 125V AC @ 10,000A
	LR39772		1A - 5A / 125V AC @ 500A
	JET1037-31003-1010 JET1037-31003-1011 JET1037-31003-1007		>5A - 15A / 125V AC @ 300A

* I.R. = INTERRUPTING RATING = SHORT CIRCUIT RATING (AMPS)

Specifications subject to change without notice



Bel Fuse Inc.
206 Van Vorst Street
Jersey City, NJ 07302 USA

+1 201.432.0463
techhelp@belf.com
belfuse.com

Type 5MT / 5MTP

Medium Blow Fuse Series

HF Pb 5MT/5MTP Series, 5x20mm Glass Tube Medium Blow Fuse

RoHS 6 Compliant

Environmental Specifications

Shock Resistance	MIL-STD-202G, Method 213B, Test Condition 1 (100 G's peak for 6 milliseconds; Sawtooth waveform)
Vibration Resistance	MIL-STD-202G, Method 201A(10-55 Hz, 0.06 inch, total excursion).
Salt Spray Resistance	MIL-STD-202G, Method 101E, Test Condition B(48 hrs).
Insulation Resistance	MIL-STD-202G, Method 302, Test Condition A (After Opening) 10, 000 ohms minimum.
Solderability	MIL-STD-202G, Method 208H
Resistance to solder Heat	MIL-STD-202G, Method 210F, Test Condition B.(260+/-5°C, 10+/-1 sec)
Thermal Shock	MIL-STD-202G, Method 107G, Test Condition B (-65°C to +125°C).
Operating Temperature	-55°C to +125°C
Terminal Strength	IEC-68-2-21

Electrical Specifications

Catalog Number	Ampere Rating	Typical Cold Resistance (ohm)	Volt-drop @100% In (Volt) max.	Voltage and Interrupting Ratings	Melting I ² T <10 mSec (A ² Sec)	Melting I ² T @10 In (A ² Sec)	Maximum Power Dissipation (W)	Agency Approvals		
								UL	CS	PS
5MT(P) 100-R	100mA	11.9	2.02	See Table of Safety Approvals on Page 1 for Voltage and associated Interrupting Ratings	0.02	0.04	0.30	Y	Y	
5MT(P) 125-R	125mA	7.92	1.77		0.04	0.07	0.32	Y	Y	
5MT(P) 160-R	160mA	4.82	1.33		0.06	0.11	0.34	Y	Y	
5MT(P) 200-R	200mA	3.11	1.13		0.11	0.18	0.36	Y	Y	
5MT(P) 250-R	250mA	2.12	0.94		0.18	0.30	0.38	Y	Y	
5MT(P) 300-R	300mA	1.51	0.80		0.31	0.50	0.37	Y	Y	
5MT(P) 375-R	375mA	1.07	0.73		0.47	0.75	0.40	Y	Y	
5MT(P) 500-R	500mA	0.61	0.57		0.88	1.40	0.43	Y	Y	
5MT(P) 600-R	600mA	0.430	0.44		1.5	2.3	0.45	Y	Y	
5MT(P) 700-R	700mA	0.340	0.42		2.2	2.5	0.48	Y	Y	
5MT(P) 750-R	750mA	0.290	0.39		2.3	3.5	0.49	Y	Y	
5MT(P) 800-R	800mA	0.261	0.36		3.8	4.2	0.49	Y	Y	
5MT(P) 1-R	1A	0.183	0.33		4.2	6.4	0.49	Y	Y	Y
5MT(P) 1.25-R	1.25A	0.124	0.28		7.2	11	0.52	Y	Y	Y
5MT(P) 1.6-R	1.6A	0.081	0.23		12	18	0.55	Y	Y	Y
5MT(P) 2-R	2A	0.061	0.22		20	29	0.59	Y	Y	Y
5MT(P) 2.5-R	2.5A	0.043	0.19		35	49	0.65	Y	Y	Y
5MT(P) 3-R	3A	0.036	0.19		58	82	0.74	Y	Y	Y
5MT(P) 3.5-R	3.5A	0.029	0.18		76	105	0.84	Y	Y	Y
5MT(P) 4-R	4A	0.025	0.18		99	136	0.91	Y	Y	Y
5MT(P) 5-R	5A	0.019	0.17		167	226	1.10	Y	Y	Y
5MT(P) 6-R	6A	0.014	0.16		315	428	1.30			Y
5MT(P) 7-R	7A	0.012	0.15		750	1059	2.10			Y

Consult manufacturer for other ratings

Specifications subject to change without notice



Bel Fuse Inc.
206 Van Vorst Street
Jersey City, NJ 07302 USA

+1 201.432.0463
techhelp@belf.com
belfuse.com

Type 5MT / 5MTP

Medium Blow Fuse Series

HF  5MT/5MTP Series, 5x20mm Glass Tube Medium Blow Fuse

RoHS 6 Compliant

Average Time Current Curve

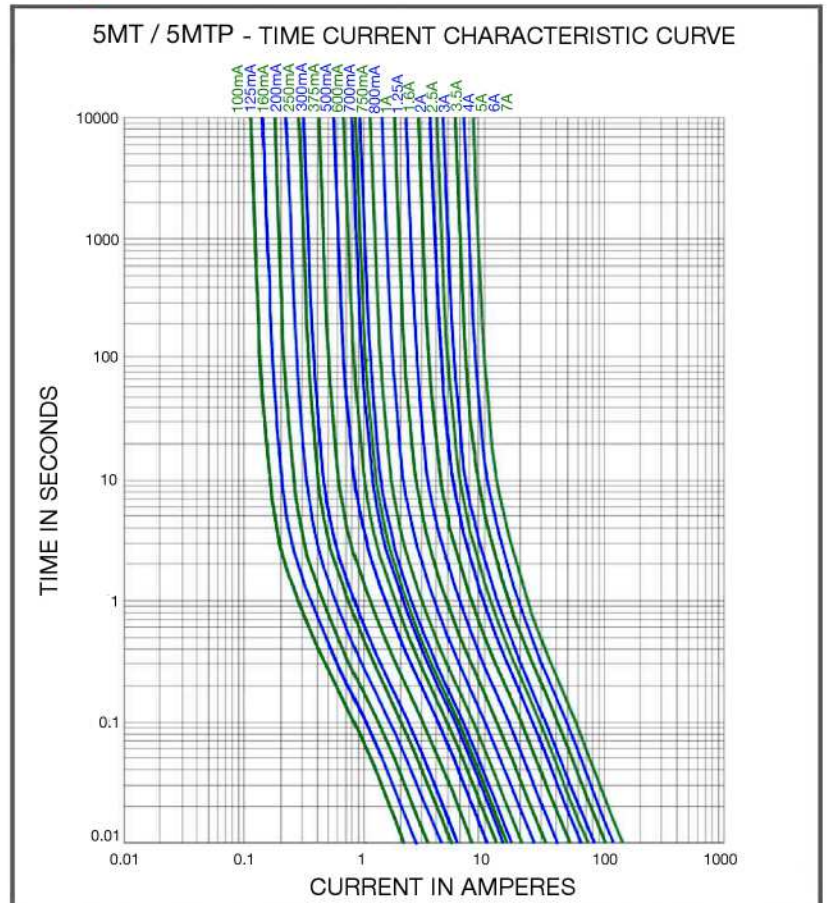

Temperature Derating Curve

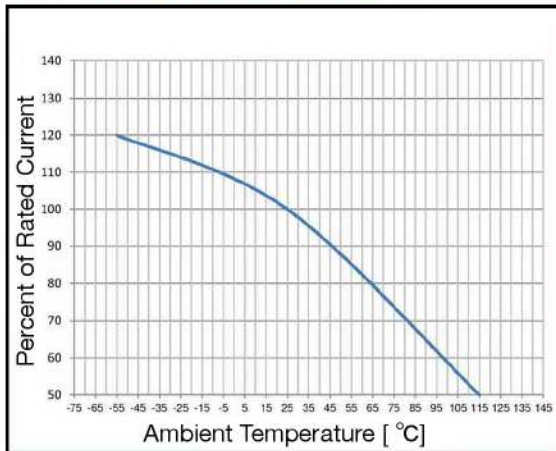

Soldering Parameters

Lead-free Wave Soldering Profile	
Wave Soldering Parameter	
Average ramp-up rate	200 °C / second
Heating rate during preheat	typical 1 - 2 °C / second Max 4 °C / second
Final preheat temperature	within 125 °C of soldering temperature
Peak temperature T_p	260 °C
Time within +0 °C / -5 °C of actual peak temperature	10 seconds
Ramp-down rate	5 °C / second max.

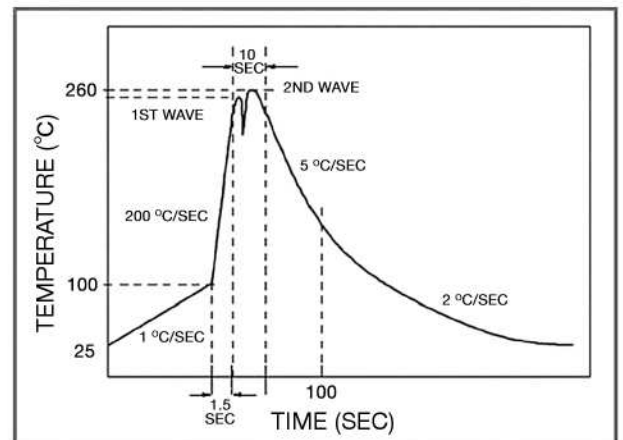

Specifications subject to change without notice



Bel Fuse Inc.
206 Van Vorst Street
Jersey City, NJ 07302 USA

+1 201.432.0463
techhelp@belf.com
belfuse.com

Type 5MT / 5MTP

Medium Blow Fuse Series

HF  5MT/5MTP Series, 5x20mm Glass Tube Medium Blow Fuse

RoHS 6 Compliant

Fuse FGNO Explanation 0652 R [XXXX] - XX

[XXXX]=Ampere Rating; XX=See Ordering Information as below

Fraction	Decimal	Milliamps	Bel FGNO[XXXX]	Fraction	Decimal	Amps	Bel FGNO[XXXX]
1/10	0.100	100	0100		1.0	1	1000
1/8	.125	125	0125	1-1/4	1.25	1.25	1250
	.160	160	0160		1.60	1.6	1600
2/10	.200	200	0200		2.0	2	2000
1/4	.250	250	0250	2-1/2	2.5	2.5	2500
3/10	.300	300	0300		3.0	3	3000
3/8	.375	375	0375	3-1/2	3.5	3.5	3500
1/2	.500	500	0500		4.0	4	4000
6/10	.600	600	0600		5.0	5	5000
7/10	.700	700	0700		6.0	6	6000
3/4	.750	750	0750		7.0	7	7000
8/10	.800	800	0800				

Mechanical Dimensions

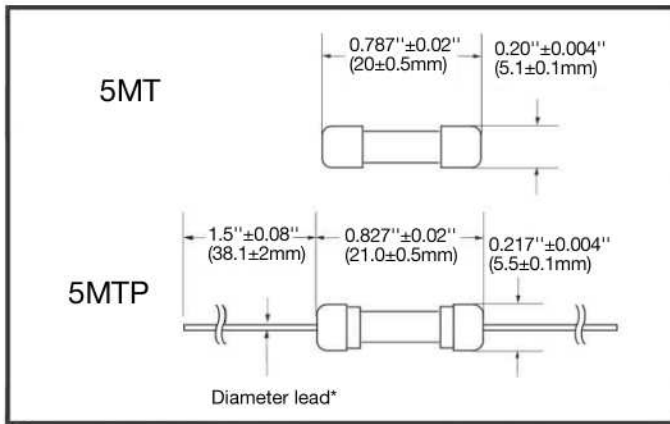

*Ratings 5A and less have 0.032" diameter lead;
*Ratings 6A and above have 0.040" diameter lead.

Ordering Information

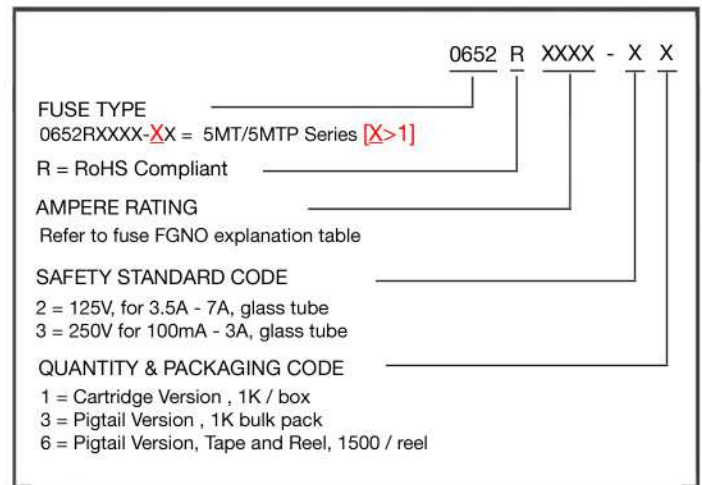

Packaging

Packaging Option	Packaging Specification	Quantity	Packaging Code	Inside Tape Spacing
Bulk	N/A	1000	33/21	N/A
Bulk (Pigtail Type)	N/A	1000	33/23	N/A
Tape & Reel, 10mm Pitch	EIA-296-F	1500	36/26	63

Specifications subject to change without notice



Bel Fuse Inc.
206 Van Vorst Street
Jersey City, NJ 07302 USA

+1 201.432.0463
techhelp@belf.com
belfuse.com