



Chipsmall Limited consists of a professional team with an average of over 10 year of expertise in the distribution of electronic components. Based in Hongkong, we have already established firm and mutual-benefit business relationships with customers from,Europe,America and south Asia,supplying obsolete and hard-to-find components to meet their specific needs.

With the principle of “Quality Parts,Customers Priority,Honest Operation,and Considerate Service”,our business mainly focus on the distribution of electronic components. Line cards we deal with include Microchip,ALPS,ROHM,Xilinx,Pulse,ON,Everlight and Freescale. Main products comprise IC,Modules,Potentiometer,IC Socket,Relay,Connector.Our parts cover such applications as commercial,industrial, and automotives areas.

We are looking forward to setting up business relationship with you and hope to provide you with the best service and solution. Let us make a better world for our industry!



## Contact us

Tel: +86-755-8981 8866 Fax: +86-755-8427 6832

Email & Skype: info@chipsmall.com Web: www.chipsmall.com



Address: A1208, Overseas Decoration Building, #122 Zhenhua RD., Futian, Shenzhen, China

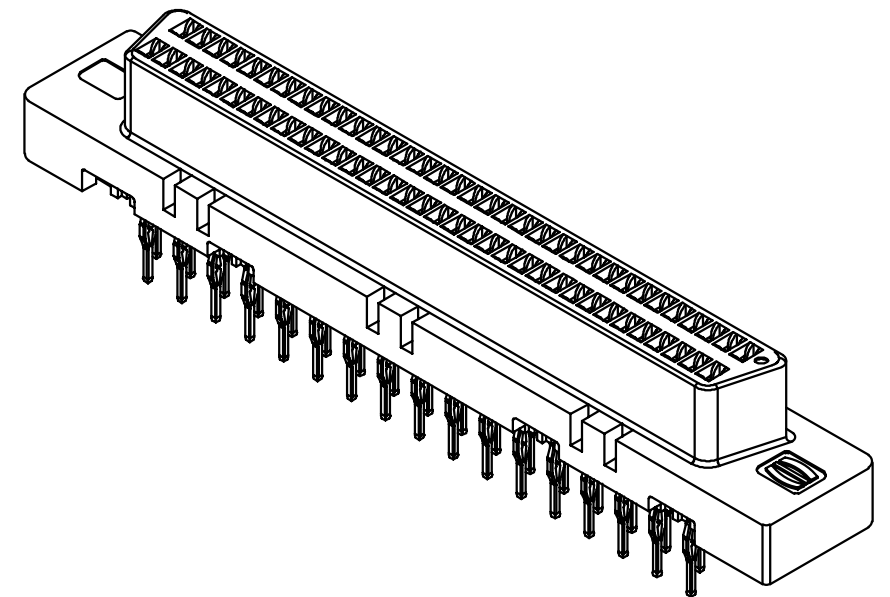
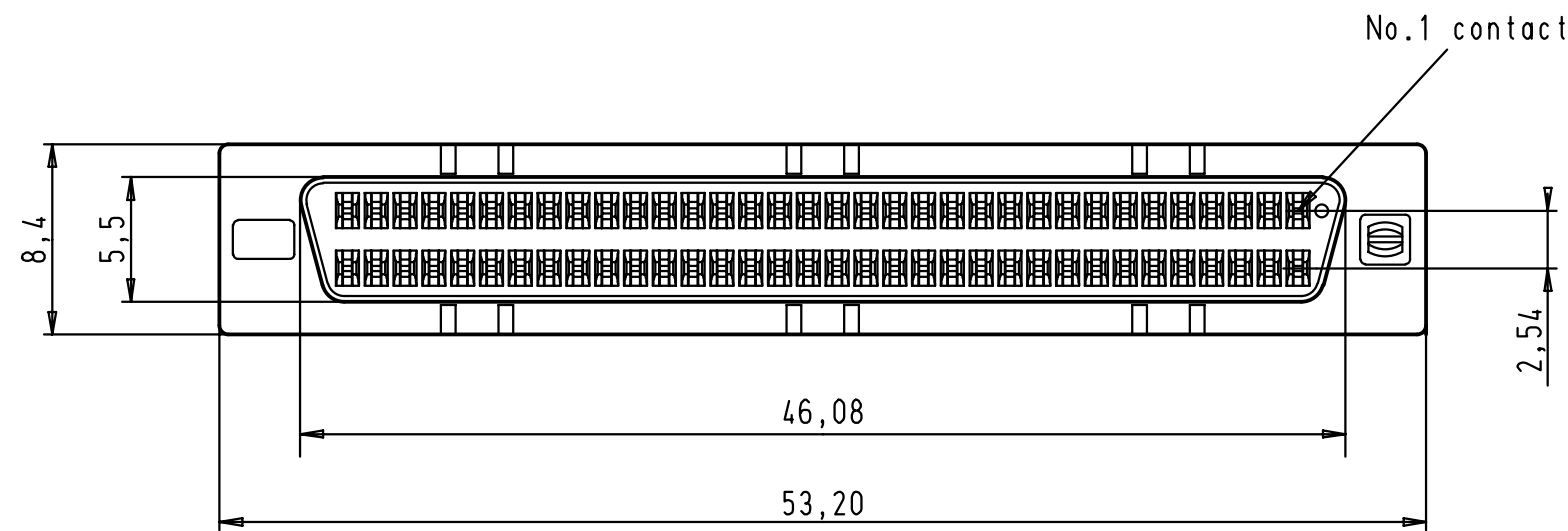
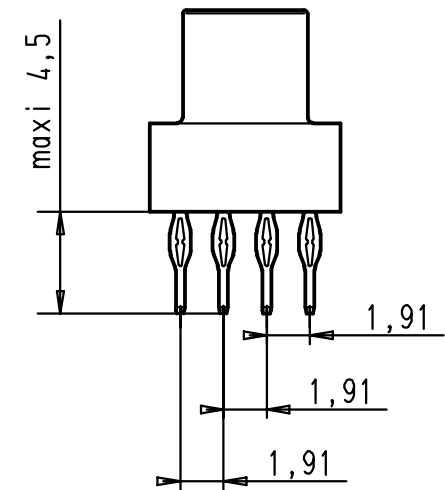
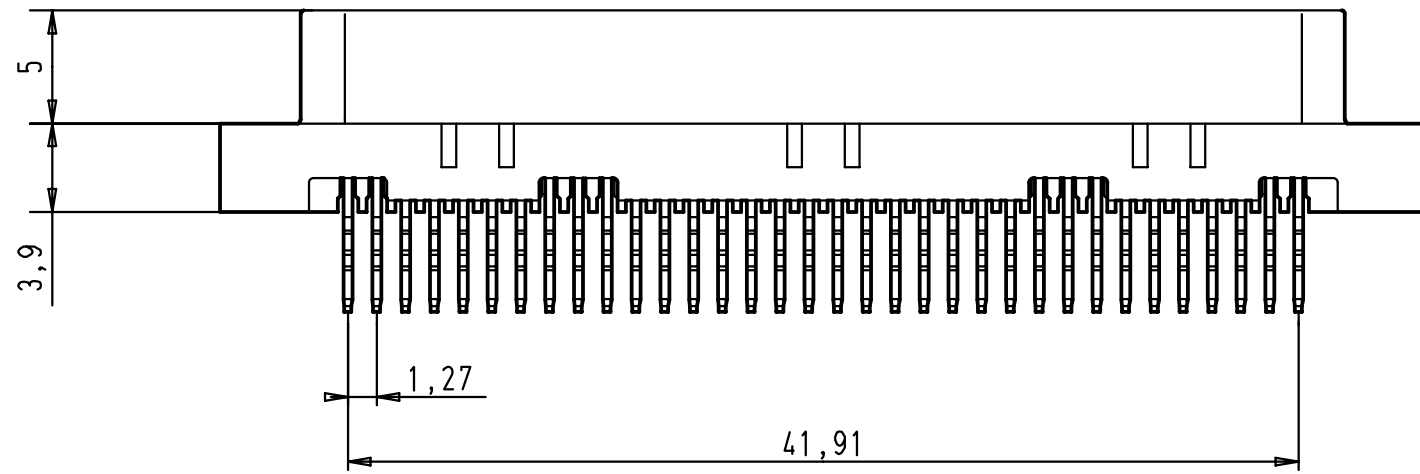

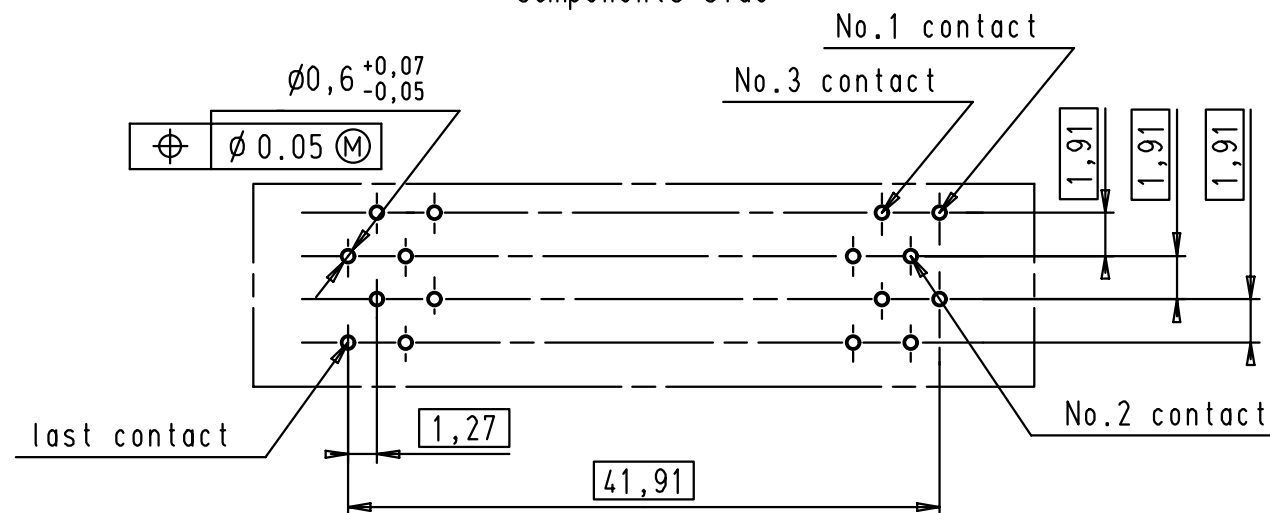

layout holes for PCB  
1,6 to 3,2 thickness  
68 poles  
Components side



Mod.	Dat.	Name	Detail.	Dat.	Name	 All Dim. in mm Orig. Size DIN A 3	har.mik® I/O pin/socket SCSI 3 68 poles har.press straight female connector plastic version	Maßstab/ Scale
27941	30-AUG-00	JB	Insp.	27/05/98	jfb			3:1
26597	02-05-00	jfb	Stand.					
23297	04-06-99	jfb	HARTING EURL F-95972 Paris				TB 60 05 068 5322	Blatt/ Page
23225	27-05-98	jfb						1 / 1
								Sub.

Alle Rechte vorbehalten/ All rights reserved