



Chipsmall Limited consists of a professional team with an average of over 10 year of expertise in the distribution of electronic components. Based in Hongkong, we have already established firm and mutual-benefit business relationships with customers from,Europe,America and south Asia,supplying obsolete and hard-to-find components to meet their specific needs.

With the principle of “Quality Parts,Customers Priority,Honest Operation,and Considerate Service”,our business mainly focus on the distribution of electronic components. Line cards we deal with include Microchip,ALPS,ROHM,Xilinx,Pulse,ON,Everlight and Freescale. Main products comprise IC,Modules,Potentiometer,IC Socket,Relay,Connector.Our parts cover such applications as commercial,industrial, and automotives areas.

We are looking forward to setting up business relationship with you and hope to provide you with the best service and solution. Let us make a better world for our industry!



Contact us

Tel: +86-755-8981 8866 Fax: +86-755-8427 6832

Email & Skype: info@chipsmall.com Web: www.chipsmall.com

Address: A1208, Overseas Decoration Building, #122 Zhenhua RD., Futian, Shenzhen, China



Improved Design for a More Lightweight Construction and Reduced Standby Power Consumption.

- Standby power reduced to 85% or less of previous models. (Applicable to 61F-GN.)
- Weighs only 85% or less of previous models. (Applicable to 61F-G3N/-G4N.)
- Easy identification of operating status with LED operation indicator.
- Increased reliability of internal relay (micro load: 5 VDC, 1 mA) to enable PLC input.
- Electrode terminals and other wiring terminals are separated for easy wiring.
- Select from three mounting methods: JEM, DIN rail mounting, or screw mounting.

Note: LED operation indicator is provided on Controllers manufactured in August 1999 or later.

 Refer to *Safety Precautions for Floatless Level Controllers.*



61F-G□N (120/240 VAC) in this catalog have been discontinued at the end of March 2018.

Model Number Structure

Model Number Legend

61F-□N□
1 2

1. Controller Application

- G: Automatic water supply and drainage
- G1: Automatic water supply with idling prevention or water shortage alarm
- G2: Automatic water supply and drainage with abnormal water increase alarm
- G3: Automatic water supply and drainage with full tank and water shortage alarm
- G4: Automatic water supply with water level indicator for water supply tank and water receiving tank and prevention of idling due to water shortage
- I: Liquid level indication and alarm (no two-wire models)

2. Type

- Blank: General-purpose
- L 2KM: Long-distance (for 2 km)
- L 4KM: Long-distance (for 4 km)
- H: High-sensitivity
- D: Low-sensitivity
- R: Two-wire

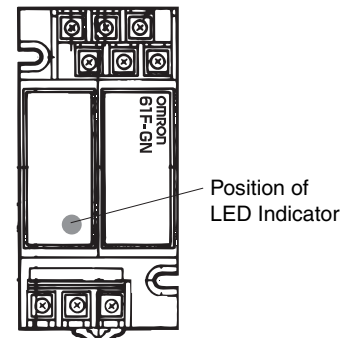

Note: LED indicator is provided on Controllers manufactured in August 1999 or later. It is not mounted on the case surface. It can be seen through the case.

Specifications

Standard Models

Items	Type	General-purpose Controllers 61F-□N	Long-distance Controllers 61F-□NL 2KM (2 km) 61F-□NL 4KM (4 km)	High-sensitivity Controllers 61F-□NH
Controlling materials and operating conditions		For control of ordinary purified water and wastewater	For control of ordinary purified water and wastewater. Particularly in cases where the distance between the pumps and water tanks or between supply and receiver tanks are far apart or where remote control is required.	For control of liquids with high specific resistance, such as distilled water
Rated voltage		100/200, 110/220 or 120/240 VAC, 50/60 Hz (both supported on same model)		
Allowable voltage fluctuation range		85% to 110% of rated voltage		
Inter-electrode voltage		8 VAC		
Inter-electrode current		Approx. 1 mA AC max.		
Power consumption		GN□: 3 VA max., G1N□, G2N□, IN□: 4 VA max., G3N□: 5.5 VA max., G4N□: 8.5 VA max.		
Inter-electrode operation resistance (recommended values)		0 to approx. 4 kΩ	0 to 1.8 kΩ (for 2 km) 0 to 0.7 kΩ (for 4 km)	Approx. 10 kΩ to 40 kΩ (See note 4.)
Inter-electrode release resistance (recommended values)		Approx. 15 k to ∞Ω	4 k to ∞Ω (for 2 km) 2.5 k to ∞Ω (for 4 km)	Approx. 100 k to ∞Ω
Cable length (See note 2.)		1 km max.	2 km max. 4 km max.	50 m max.
Output		3 A, 200 VAC (Resistive load)		
Ambient operating temperature		-10 to 55°C		
Ambient operating humidity		45% to 85%		
Insulation resistance (See note 3.)		100 MΩ min. (at 500 VDC)		
Dielectric strength (See note 3.)		2,000 VAC, 50/60 Hz for 1 min.		
Life expectancy		Electrical: 250,000 operations min. Mechanical: 10,000,000 operations min.		
Weight		GN models: 315 g; G1N, G2N, IN models: 410 g; G3N models: 625g; G4N models: 870 g		
Internal Circuit Diagrams		Example: 61F-GN 	Example: 61F-GNL 	Example: 61F-GNH

Note: 1. The □ in the model name represents G, G1, G2, G3, G4, or I.

- The length when using completely insulated, 600-V, 3-core (0.75 mm²) cabtire cables. Usable cable lengths will become shorter as the cable diameter or number of cores becomes larger due to increased floating capacity. For details, refer to *Safety Precautions for Floatless Level Controllers*.
- The insulation resistance and dielectric strength are the values between power terminals and Electrode terminals, between power terminals and contact terminals, and between Electrode terminals and contact terminals. For details, refer to *Safety Precautions for Floatless Level Controllers*.
- Application is possible with 10 kΩ or less, however, this may cause reset failures.

Items	Type	Low-sensitivity Controller 61F-□ND	Two-wire Controller 61F-□NR
Controlling materials and operating conditions		For control of liquids with low specific resistance, such as salt water, wastewater, acid chemicals, or alkaline chemicals	For control of ordinary purified water or wastewater. Used with a Two-wire Electrode Holder (incorporating a resistor of 6.8 k Ω)
Rated voltage		100/200, 110/220 or 120/240 VAC, 50/60 Hz (supported by the same model)	
Allowable Voltage Fluctuation		85% to 110% of rated voltage	
Inter-electrode voltage		8 VAC	
Inter-electrode current		Approx. 1 mA AC max.	
Power consumption		GN□: 3 VA max., G1N□, G2N□, IN□: 4 VA max., G3N□: 5.5 VA max., G4N□: 8.5 VA max.	
Inter-electrode operation resistance (recommended values)		0 to approx. 1.8 k Ω	Approx. 0 to 1.1 k Ω
Inter-electrode release resistance (recommended values)		Approx. 5 k to ∞ Ω	Approx. 15 k to ∞ Ω
Cable length (See note 2.)		1 km max.	800 m max.
Output		3 A, 200 VAC (Resistive load)	
Ambient operating temperature		-10 to 55°C	
Ambient operating humidity		45% to 85%	
Insulation resistance (See note 3.)		100 M Ω min. (at 500 VDC)	
Dielectric strength (See note 3.)		2,000 VAC, 50/60 Hz for 1 min.	
Life expectancy		Electrical: 250,000 operations min. Mechanical: 10,000,000 operations min.	
Weight		GN models: 315 g; G1N, G2N, IN models: 410 g; G3N models: 625g; G4N models: 870 g	
Internal Circuit Diagrams		Example: 61F-GND 	Example: 61F-GNR

- Note:**
- The □ in the model name represents G, G1, G2, G3, G4, or I.
 - The length when using completely insulated, 600-V, 3-core (0.75 mm²) cabtire cables. Usable cable lengths will become shorter as the cable diameter or number of cores becomes larger due to increased floating capacity. For details, refer to *Safety Precautions for Floatless Level Controllers*.
 - The insulation resistance and dielectric strength are the values between power terminals and Electrode terminals, between power terminals and contact terminals, and between Electrode terminals and contact terminals. For details, refer to *Safety Precautions for Floatless Level Controllers*.
 - Application is possible with 10 k Ω or less, however, this may cause reset failures.

Relay Unit

The Relay Unit can be replaced without removing the wires for maintenance inspections. It can also be replaced with other Relay Units.

Compatibility with General Purpose Model (61F-11N)

General-purpose Controller	61F-11N	---
Long-distance Controllers	61F-11NL (for 2 km) 61F-11NL (for 4 km)	Provided
High-sensitivity Controllers	61F-11NH	
Low-sensitivity Controller	61F-11ND	Not provided
Two-wire Controller	61F-11NR	

Terminal Arrangement

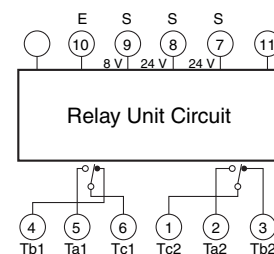

Ordering Example

If you order the components listed above, the corresponding Relay Unit will be supplied with the Controller.

Example: If a 61F-GN Controller is ordered, a 61F-11N Relay Unit will also be included.

Connections

Automatic Water Supply Control

Compact Model
61F-GN

Dimensions
page 16



Automatic Water Supply Control

Connections

- Connect contactor coil terminal to Tb.
- Connect to power supply terminals.
S₀-S₁: 110 VAC
S₀-S₂: 220 VAC

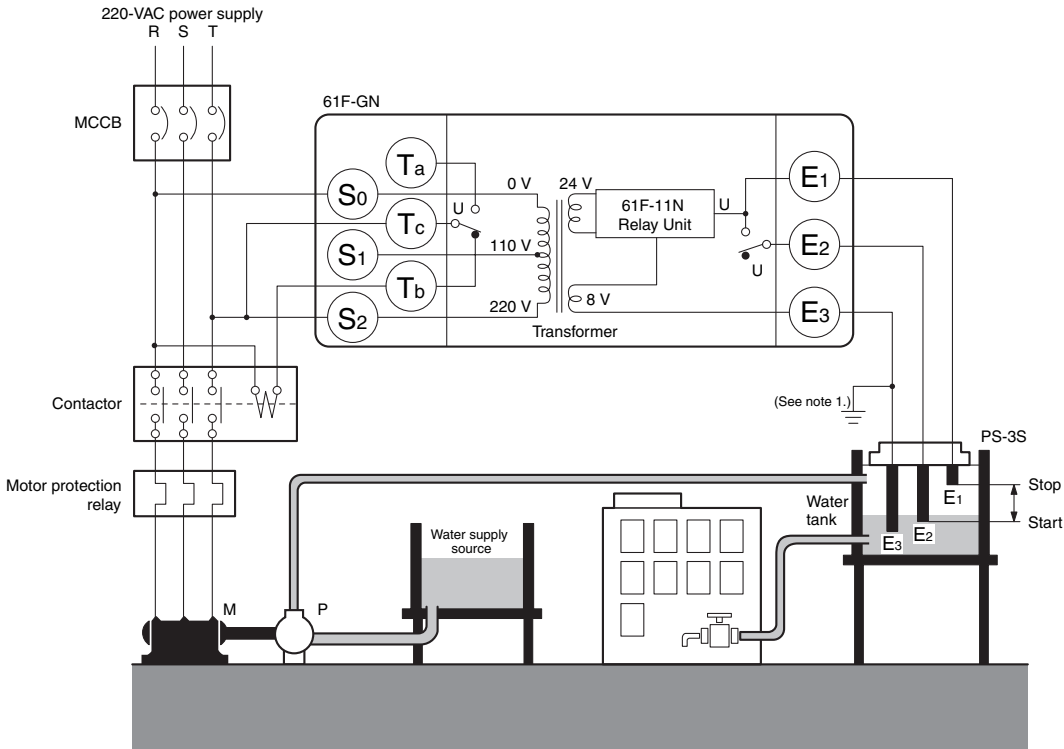

Note: 1. Be sure to ground the common Electrode E₃ (the longest Electrode).
2. The above wiring diagram is for a rated voltage of 110/220 VAC.

Principles of Operation

The pump stops (U indicator ON) when the water level reaches E₁ and starts (U indicator OFF) when the water level drops below E₂.

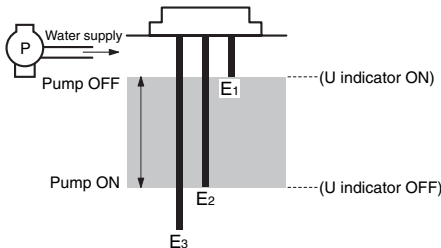

Relay Unit Layout

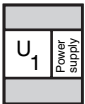

Automatic Drainage Control

Compact Model
61F-GN

Dimensions
page 16



Automatic Drainage Control

Connections

- Connect the contactor coil terminal to Ta.
- Connect to power supply terminals.
S₀-S₁: 110 VAC
S₀-S₂: 220 VAC

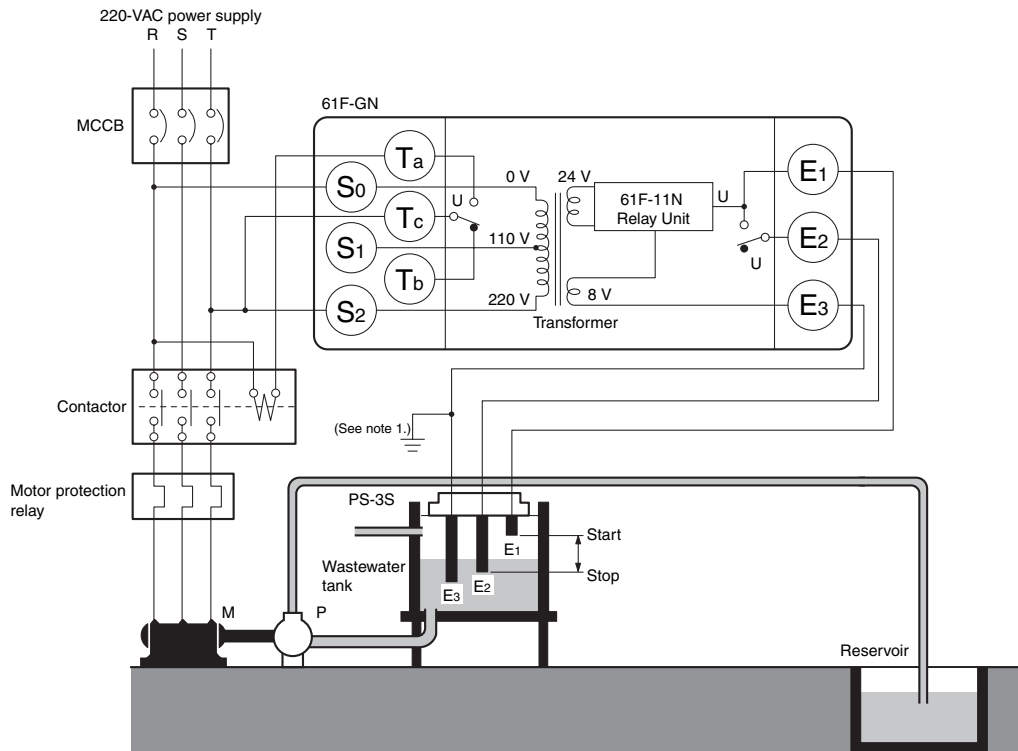

- Note: 1.** Be sure to ground the common Electrode E₃ (the longest Electrode).
2. The above wiring diagram is for a rated voltage of 110/220 VAC.

Principles of Operation

- The pump starts (U indicator ON) when the water level reaches E₁ and stops (U indicator OFF) when the water level drops below E₂.

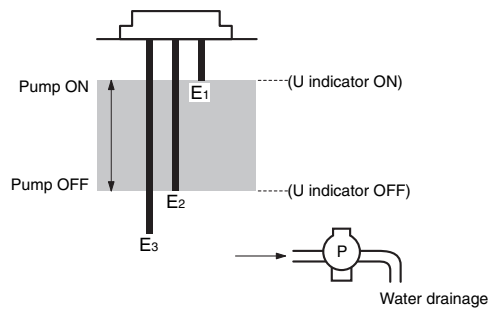

Relay Unit Layout

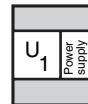

Automatic Water Supply Control with Pump Idling Prevention

Compact Model 61F-G1N



Dimensions
page 16

Automatic Water Supply Control with Pump Idling Prevention

Connections

- Connect to power supply terminals.
S₀-S₁: 110 VAC
S₀-S₂: 220 VAC
- Insert a pushbutton switch (NO contact) between E₁' and E₃ as shown by the dotted line.
- Do not press the pushbutton switch if the pump stops (U₁ indicator OFF) during normal operation after an alarm is given for a low water level (e.g., the water level does not reach E₂').

Test Operation/ Recovering from Power Interruptions

If the water supply source level has not yet reached E₁' when starting the pump or after recovering from a power interruption, press the pushbutton switch to start the pump (U₁ indicator ON) by momentarily short-circuiting E₁' and E₃.

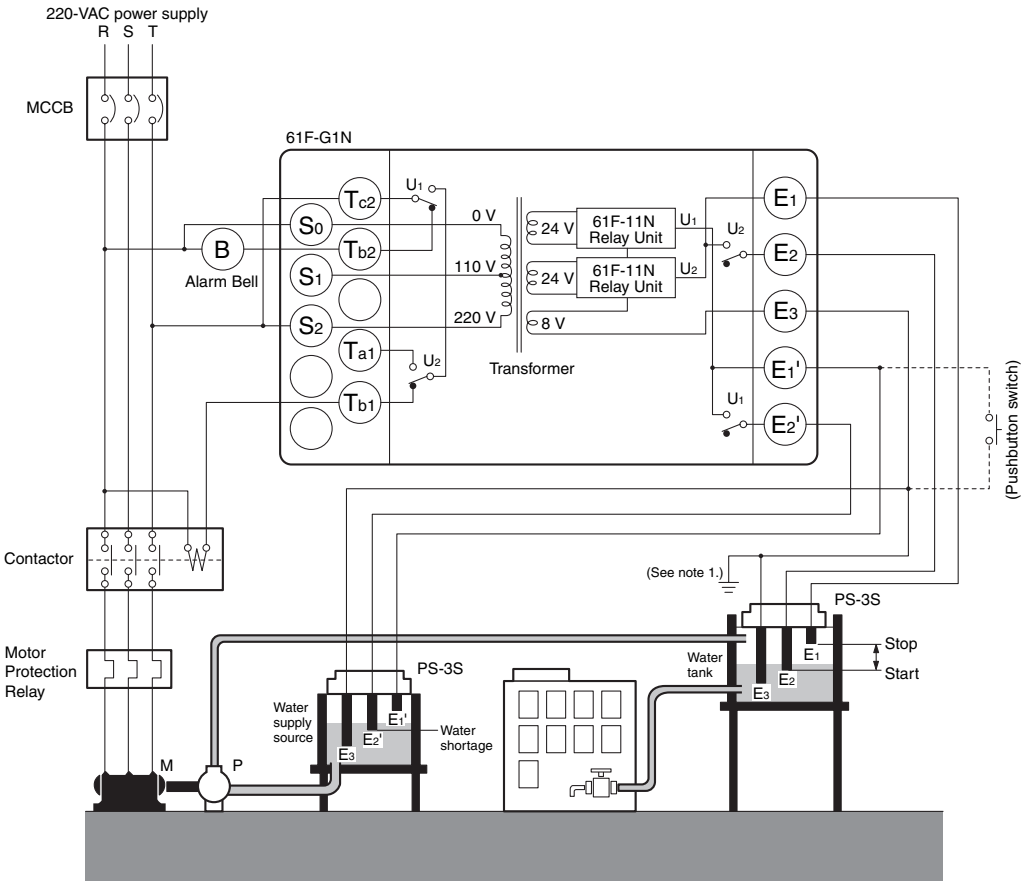

- Note: 1.** Be sure to ground the common Electrode E₃ (the longest Electrode).
2. The above wiring diagram is for a rated voltage of 110/220 VAC.

Principles of Operation

- The pump starts (U₂ indicator OFF) when the water level drops below E₂ and stops (U₂ indicator ON) when water level reaches E₁.
- The pump is forced to stop when the water supply source level drops below E₂' (U₁ indicator OFF) to prevent the pump from idling and gives an alarm.

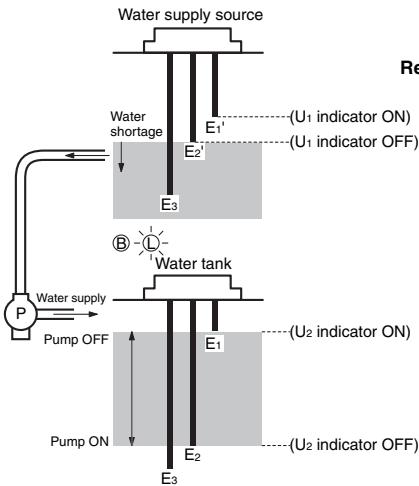

Relay Unit Layout

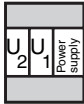

Note

- Length of Electrode E₁'
When installing the Controller in locations where there is a possibility of momentary power interrupts or blackouts, the length of E₁' should be made so that the amount of water corresponding to one pump cycle does not expose the Electrodes. This will prevent the E₂' self-holding circuit from failing.

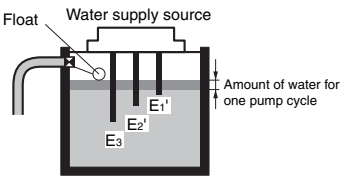

Automatic Water Supply Control with Abnormal Water Shortage Alarm

Compact Model 61F-G1N

Dimensions
page 16

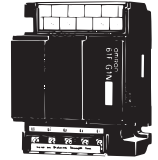

Automatic Water Supply Control with Abnormal Water Shortage Alarm

Connections

- Connect to power supply terminals.
S₀-S₁: 110 VAC
S₀-S₂: 220 VAC
- Insert a pushbutton switch (NO contact) between E₃ and E₄.
- If the pump stops upon releasing the pushbutton switch, keep pressing the pushbutton switch.
- Connect the E₄ electrode for the water shortage alarm to the E₁' terminal.

**Test Operation/
Recovering from
Power Interruptions**

If the water level has not yet reached E₄ when starting the pump or after recovering from a power interruption, press the pushbutton switch to start the pump by short-circuiting E₃ and E₄ (U₁ indicator ON).

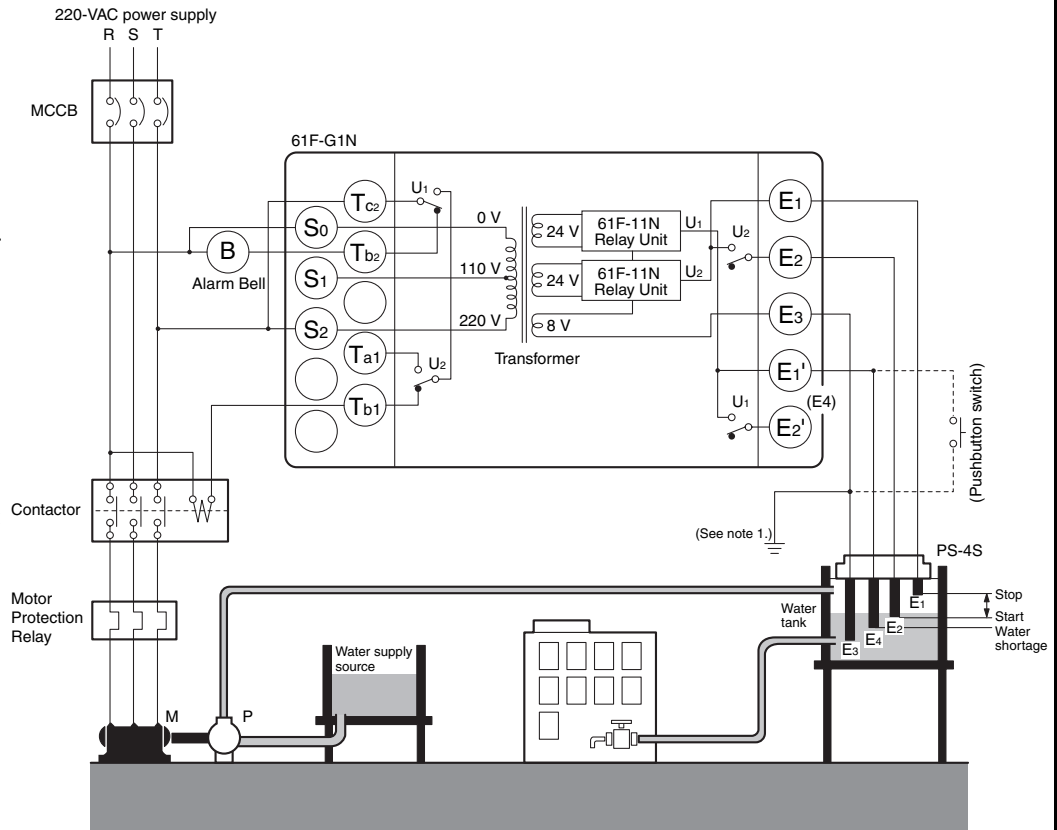

- Note:** 1. Be sure to ground the common Electrode E₃ (the longest Electrode).
2. The above wiring diagram is for a rated voltage of 110/220 VAC.

Principles of Operation

- The pump stops (U₂ indicator ON) when the water level reaches E₁ and starts (U₂ indicator OFF) when water level drops below E₂.
- If the water level drops below E₄ for any reason, an alarm is given (U₁ indicator OFF).

Relay Unit Layout

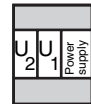
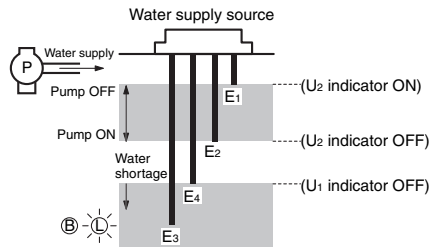

Automatic Water Supply with Abnormal Water Increase Alarm

Compact Model 61F-G2N

Dimensions
page 16

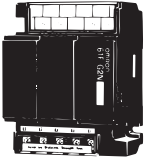

Automatic Water Supply with Abnormal Water Increase Alarm

Connections

- Connect power supply terminal S₂ to terminal Tb₁.
- Connect to power supply terminals.
S₀-S₁: 110 VAC
S₀-S₂: 220 VAC

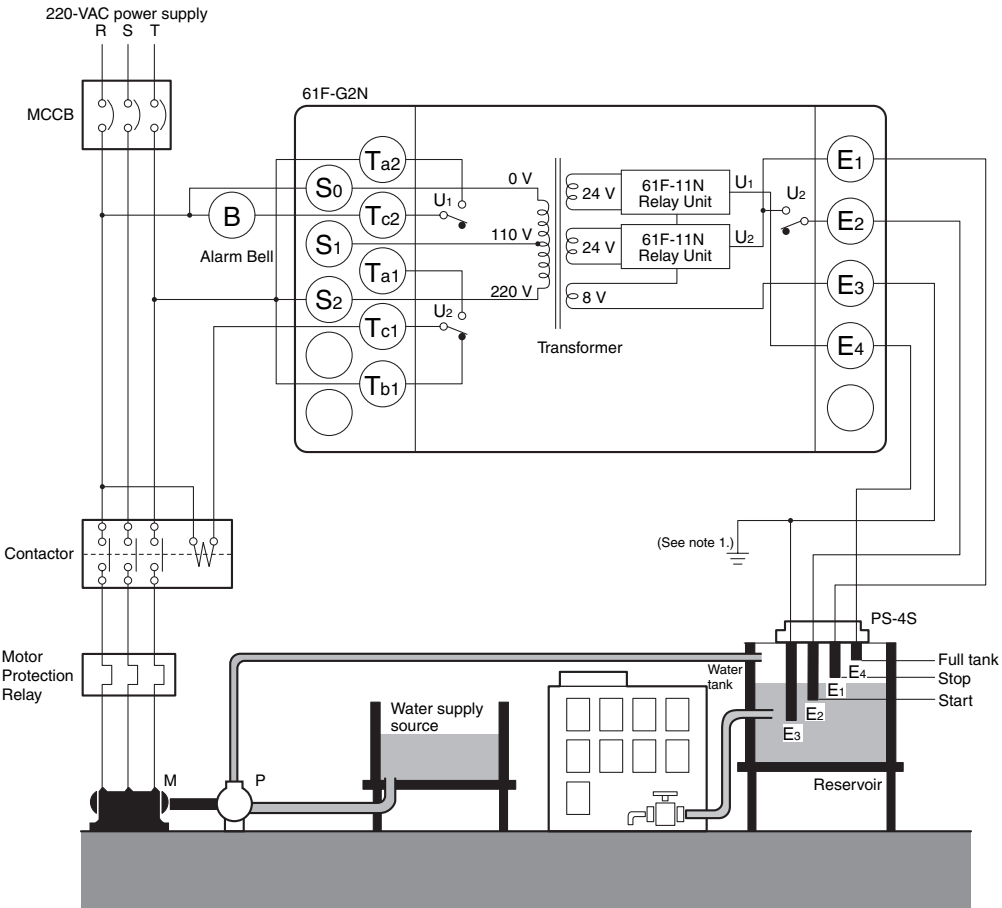

- Note: 1.** Be sure to ground the common Electrode E₃ (the longest Electrode).
2. The above wiring diagram is for a rated voltage of 110/220 VAC.

Principles of Operation

- The pump starts (U₂ indicator OFF) when the water level reaches E₂ and stops (U₂ indicator ON) when the water level rises above E₁.
- If the water level reaches E₄ for any reason, an alarm is given (U₁ indicator ON).

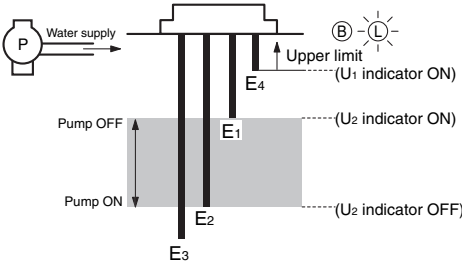

Relay Unit Layout

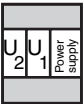

Automatic Drainage Control with Abnormal Water Increase Alarm

**Compact Model
61F-G2N**

Dimensions
page 16

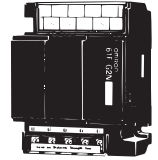

Automatic Drainage Control with Abnormal Water Increase Alarm

Connections

- Connect power supply S₂ to terminal Ta₁.
- Connect to power supply terminals.
S₀-S₁: 110 VAC
S₀-S₂: 220 VAC

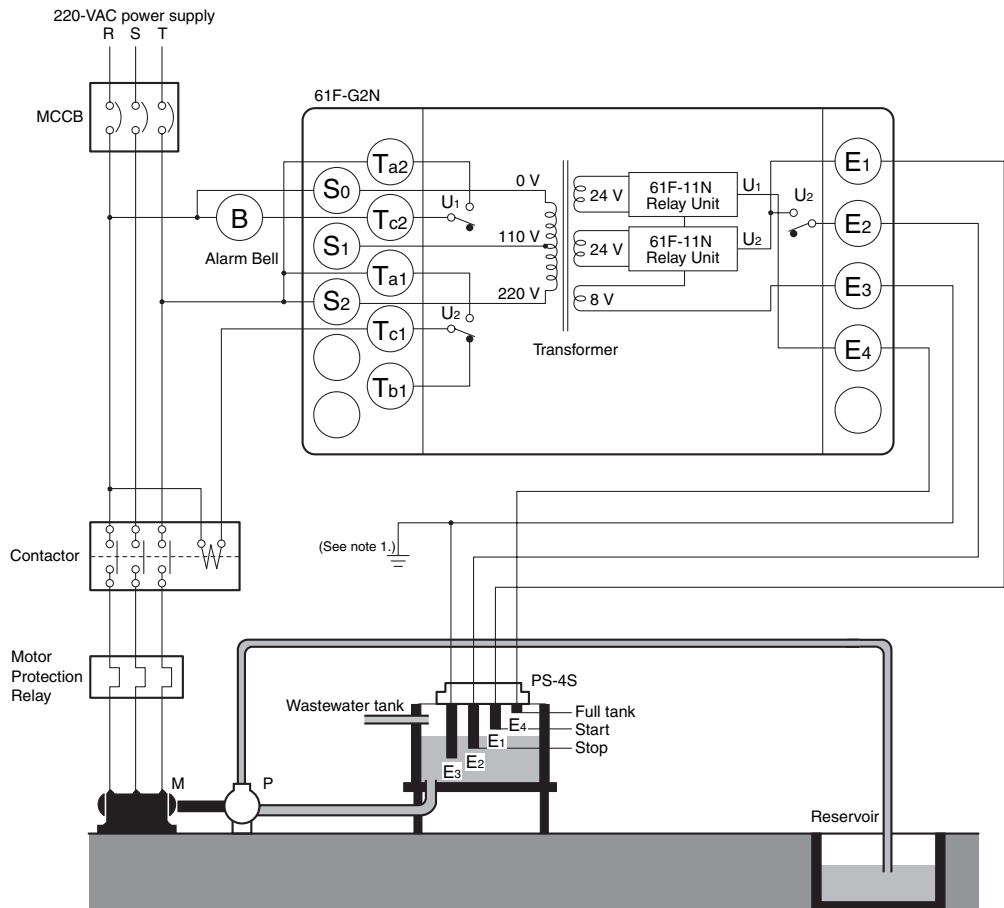

- Note: 1.** Be sure to ground the common Electrode E₅ (the longest Electrode).
2. The above wiring diagram is for a rated voltage of 110/220 VAC.

Principles of Operation

- The pump starts (U₂ indicator ON) when the water level reaches E₁ and stops (U₂ indicator OFF) when the water level drops below E₂.
- If the water level reaches E₄ for any reason, an alarm is given (U₁ indicator ON).

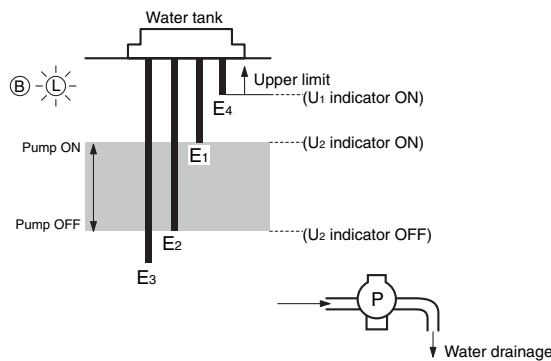

Relay Unit Layout

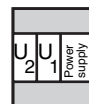

Automatic Water Supply Control with Full Tank and Water Shortage Alarm

Compact Model
61F-G3N

Dimensions
page 17

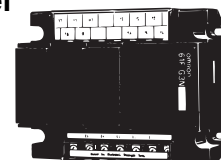

Automatic Water Supply Control with Full Tank and Water Shortage Alarm

Connections

- Connect contactor coil terminal to Tb.
- Connect to power supply terminals.
S₀-S₁: 110 VAC
S₀-S₂: 220 VAC

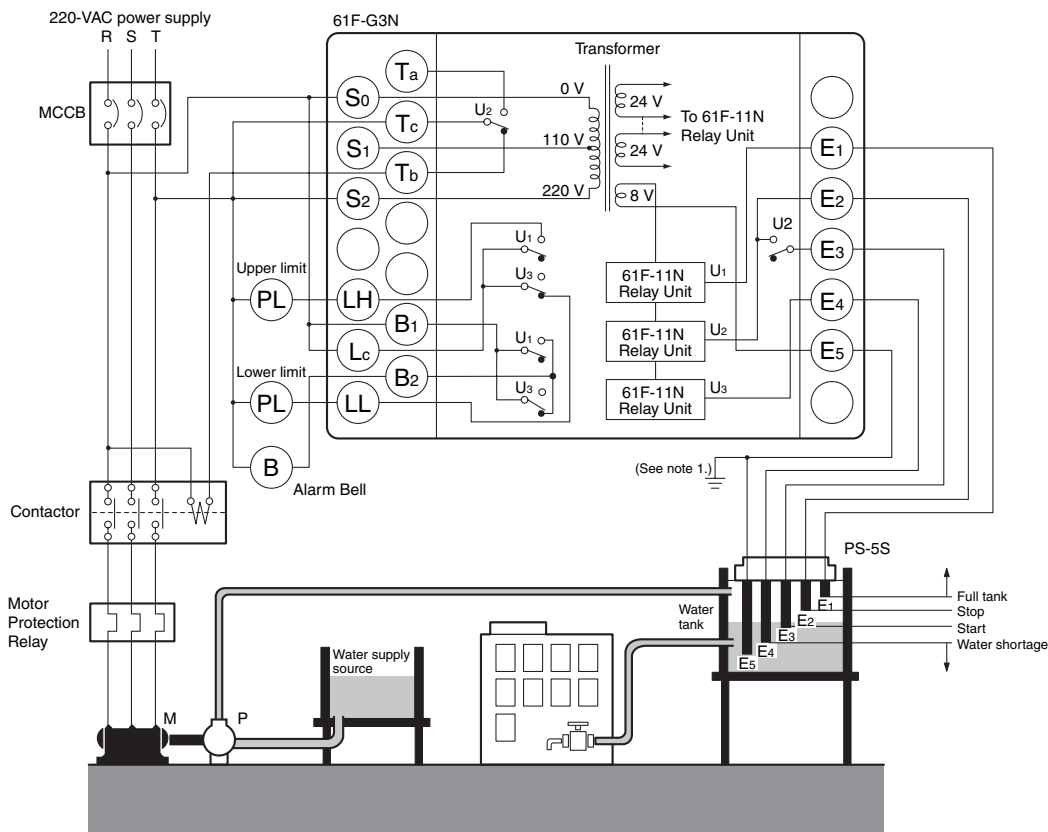

- Note: 1.** Be sure to ground the common Electrode E₅ (the longest Electrode).
2. The above wiring diagram is for a rated voltage of 110/220 VAC.

Principles of Operation

- The pump starts (U₂ indicator ON) when the water level reaches E₂ and stops (U₂ indicator OFF) when the water level drops below E₃.
- If the water level rises to E₁ for any reason, the upper-limit indicator turns ON and an alarm is given (U₁ indicator ON). If the water level drops below E₄ for any reason, the lower-limit indicator turns ON and an alarm is given (U₃ indicator OFF).

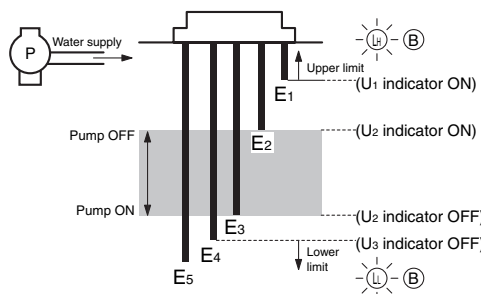

Relay Unit Layout

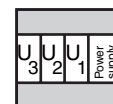

Automatic Drainage Control with Full Tank and Water Shortage Alarm

Compact Model 61F-G3N

Dimensions
page 17

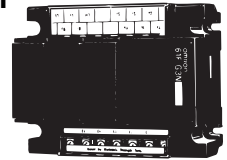

Automatic Drainage Control with Full Tank and Water Shortage Alarm

Connections

- Connect contactor coil terminal to Ta.
- Connect to power supply terminals.
S₀-S₁: 110 VAC
S₀-S₂: 220 VAC

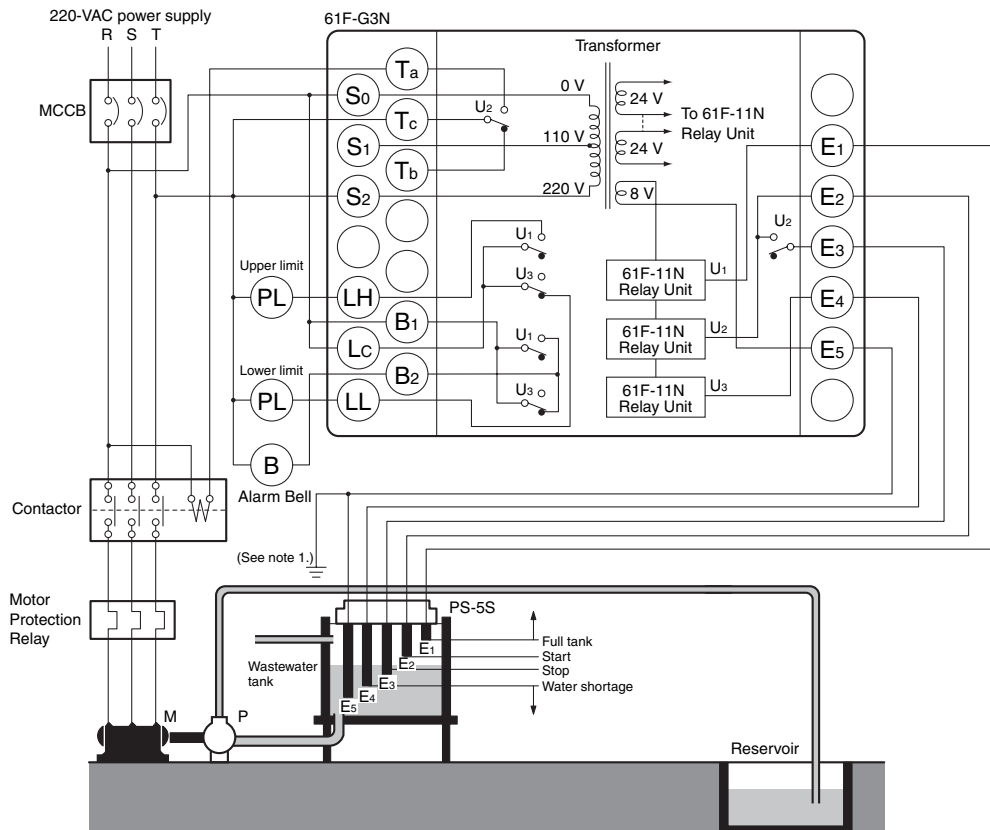

- Note: 1.** Be sure to ground the common Electrode E₅ (the longest Electrode).
2. The above wiring diagram is for a rated voltage of 110/220 VAC.

Principles of Operation

- The pump starts (U₂ indicator ON) when the water level reaches E₂ and stops (U₂ indicator OFF) when the water level reaches E₃.
- If the water level rises to E₁ for any reason, the upper-limit indicator turns ON and an alarm is given (U₁ indicator ON). If the water level drops below E₄ for any reason, the lower-limit indicator turns ON and an alarm is given (U₃ indicator OFF).

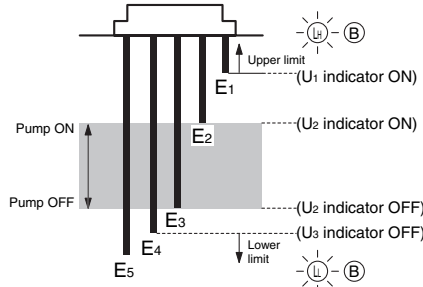

Relay Unit Layout

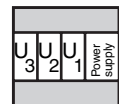

Water Source Level Indication with Prevention of Pump Idling Due to Water Shortage, and Automatic Water Supply Control with Indication of Water Level in Elevated Tank

Compact Model 61F-G4N

Dimensions page 17

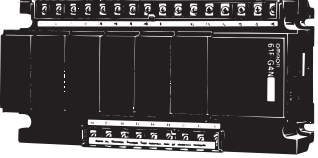

Water Source Level Indication with Prevention of Pump Idling Due to Water Shortage, and Automatic Water Supply Control with Indication of Water Level in Elevated Tank

Connections

- Connect to power supply terminals.
S₀-S₁: 110 VAC
S₀-S₂: 220 VAC
- Insert a pushbutton switch (NO contact) between E₂ and E₈ as shown by the dotted line.
- Do not press the pushbutton switch if the pump stops during normal operation after an alarm is given for low water level (i.e., the water level has not reached E₃).

Test Operation/ Recovering from Power Interruptions

When starting the pump and after recovering from a power interruption, if the water source level has not yet reached E₂ (U₂ indicator OFF), press the pushbutton switch to start the pump by momentarily short-circuiting E₂ and E₈.

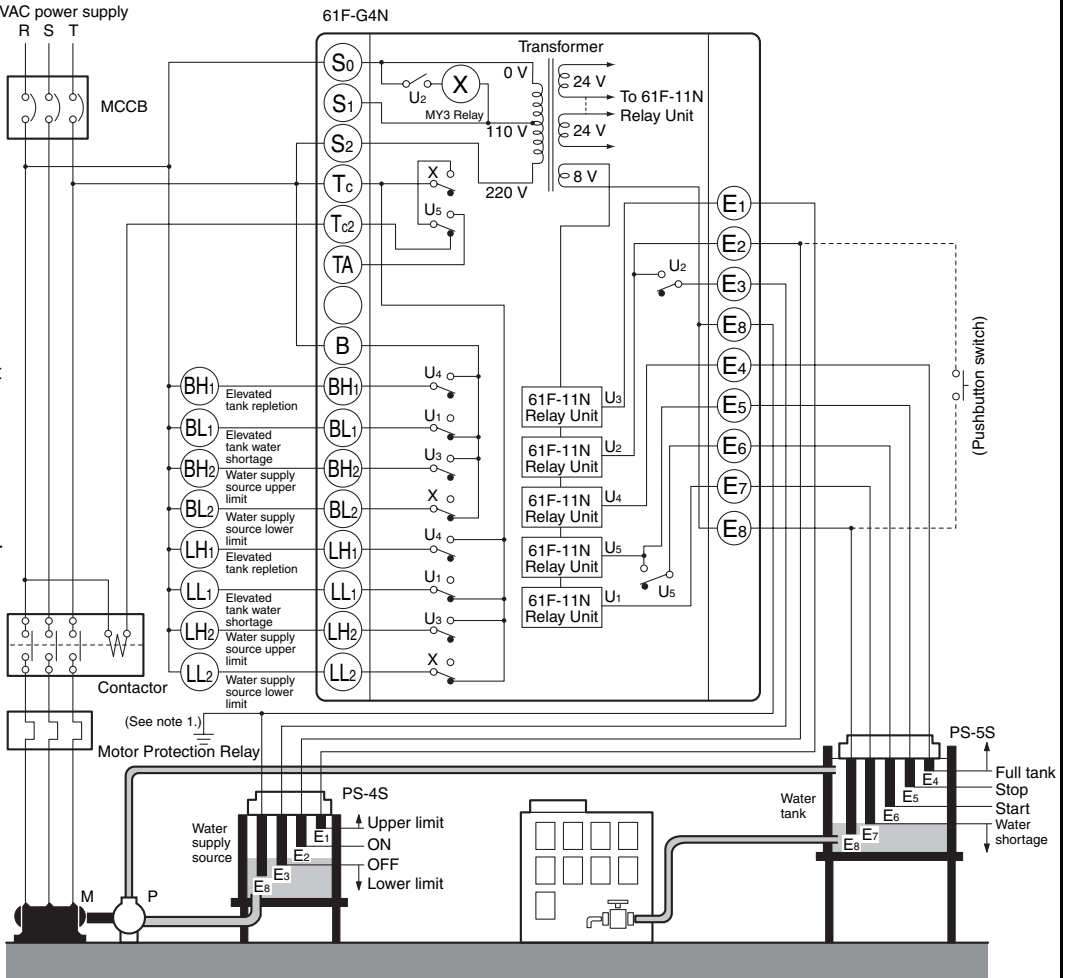

Note: 1. Be sure to ground the common Electrode E₈ (the longest Electrode).
2. The above wiring diagram is for a rated voltage of 110/220 VAC.

Principles of Operation

- Insert four Electrodes in the water supply source and five Electrodes in the elevated water tank.
- The lower-limit indicator for the water supply source remains ON while the water source level is below E₃ (U₂ indicator OFF).
- When the water level rises to E₂, the lower-limit indicator turns OFF (U₂ indicator ON) and the pump is ready for operation.
- When the water level reaches E₁, the upper-limit indicator turns ON (U₃ indicator ON).
- The water-shortage indicator for the elevated tank remains ON while the water level in the elevated tank is below E₇. The indicator turns OFF (U₁ indicator ON) when the water level rises to E₇.
- The pump stops (U₅ indicator ON) when the water level reaches E₅ and starts (U₅ indicator OFF) when the water level drops below E₆.
- If the water level reaches E₄ for any reason, the tank repletion indicator for the elevated tank turns ON (U₄ indicator ON).

Relay Unit Layout

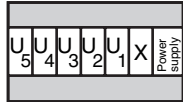

Precaution

- Length of Electrode E₂
When installing the Controller in locations where there is a possibility of momentary power interruptions or blackouts, the length of E₂ should be made so that the amount of water corresponding to one pump cycle does not expose the Electrodes. This will prevent the E₃ self-holding circuit from failing.

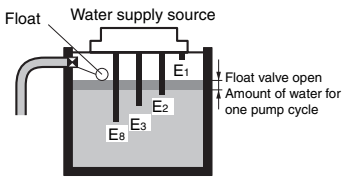

Liquid Level Indication and Alarm

Compact Model
61F-IN

Dimensions
page 16

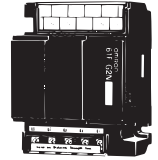

Liquid Level Indication and Alarm

Connections

- Connect to power supply terminals.
S₀-S₁: 110 VAC
S₀-S₂: 220 VAC

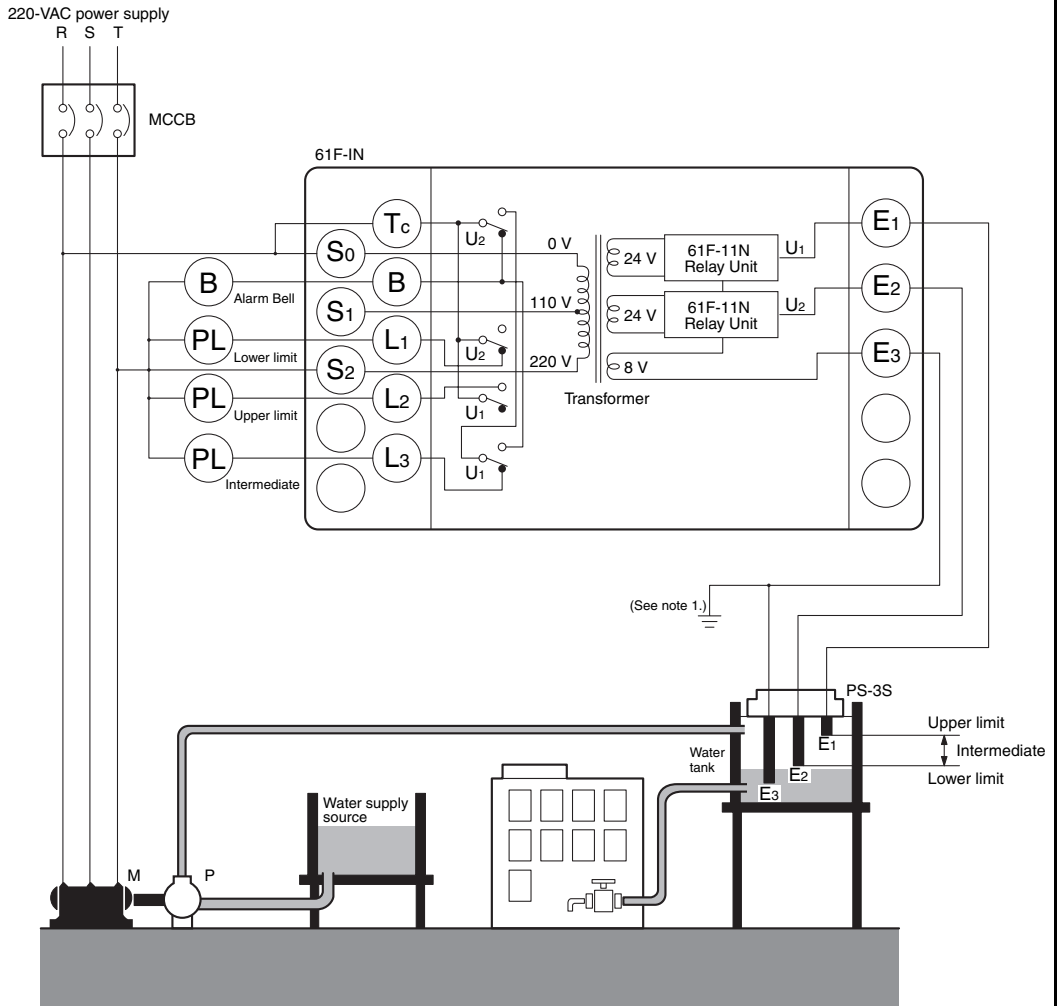

- Note:** 1. Be sure to ground the common Electrode E₃ (the longest Electrode).
2. The above wiring diagram is for a rated voltage of 110/220 VAC.

Principles of Operation

- When the water level drops below E₂, the lower-limit indicator turns ON and an alarm is given (U₂ indicator OFF).
- When the water level reaches E₂, the alarm turns OFF and the intermediate indicator turns ON (U₂ indicator ON).
- When the water level rises to E₁, the upper-limit indicator turns ON and an alarm is given (U₁ indicator ON).

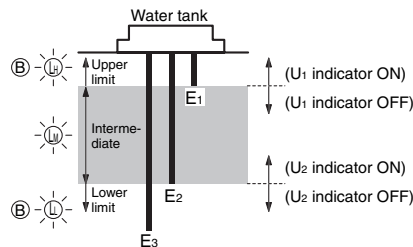

Relay Unit Layout

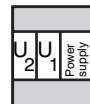

Two-wire Connection

The wiring between the 61F Controller and the Electrodes can be reduced by removing the self-hold circuit. This arrangement is called a two-wire connection. Three Electrodes are still required. Both the 61F Controller (including the Relay Unit) and Electrode Holder must be two-wire models. Two-wire Electrode Holders have an in-built resistor of 6.8 kΩ 1W.

Automatic Water Supply and Drainage Control

Compact Model 61F-GNR

Dimensions
page 16



Automatic Water Supply Control	Automatic Drainage Control
<p>Connections</p> <p>Note: 1. Be sure to ground the common Electrode E₃ (the longest Electrode).</p> <p>2. The above wiring diagram is for a rated voltage of 110/220 VAC.</p> <ul style="list-style-type: none"> • Connect contactor coil terminal to Tb. • Connect to power supply terminals. S₀-S₁: 100 VAC S₀-S₂: 200 VAC • The two-wire models require only two cables for the connection between the 61F-GNR and the Electrode Holder, but still requires three Electrodes. • A Two-wire Electrode Holder must be used. (It has an inbuilt resistance R.) • The Relay Unit must also be for two-wire models. 	<p>Connections</p> <p>Note: 1. Be sure to ground the common Electrode E₃ (the longest Electrode).</p> <p>2. The above wiring diagram is for a rated voltage of 110/220 VAC.</p> <ul style="list-style-type: none"> • Connect contactor coil terminal to Ta. (Do not connect Tb.) • Connect to power supply terminals. S₀-S₁: 100 VAC S₀-S₂: 200 VAC • The two-wire models require only two cables for the connection between 61F-GNR and the Electrode Holder, but still needs three Electrodes. • A Two-wire Electrode Holder must be used. (It has an inbuilt resistance R.) • The Relay Unit must also be for two-wire models.
<p>Principles of Operation</p> <p>The pump stops (U indicator ON) when the water level reaches E₁ and starts (U indicator OFF) when water level drops below E₂.</p>	<p>Principles of Operation</p> <p>The pump starts (U indicator ON) when the water level reaches E₁ and stops (U indicator OFF) when the water level drops below E₂.</p>

Dimensions

Note: All units are in millimeters unless otherwise indicated.

61F-GN, -GNL, -GNH, -GND, -GNR

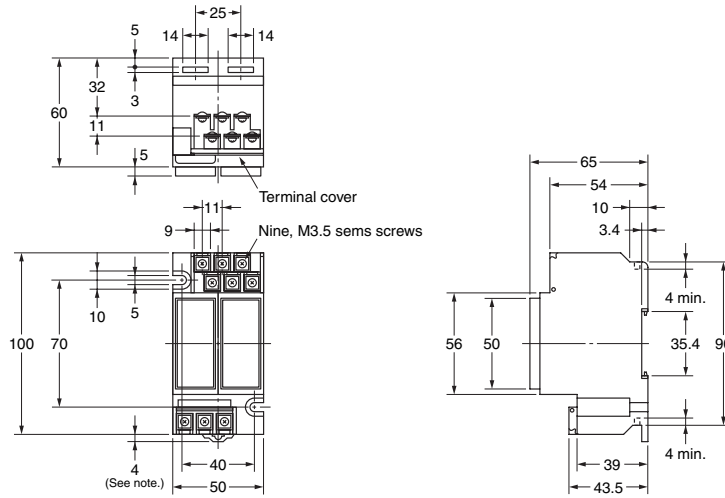

Note: Dimensions are with the DIN rail mounting (sliding) bracket attached.

61F-G1N, -G1NL, -G1NH, -G1ND, -G1NR 61F-G2N, -G2NL, -G2NH, -G2ND, G2NR 61F-IN, -NL, -INH, -IND

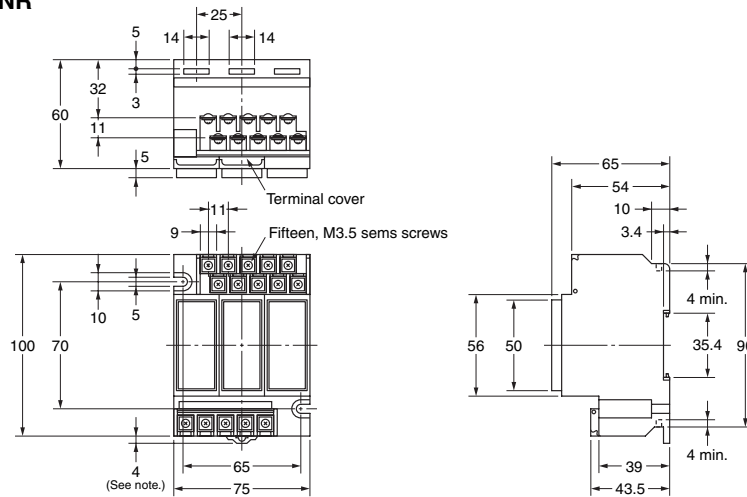
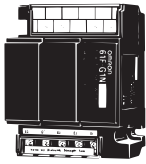

Note: Dimensions are with the DIN rail mounting (sliding) bracket attached.

61F-G3N, -G3NL, -G3NH, -G3ND, -G3NR, -G3N-NGD

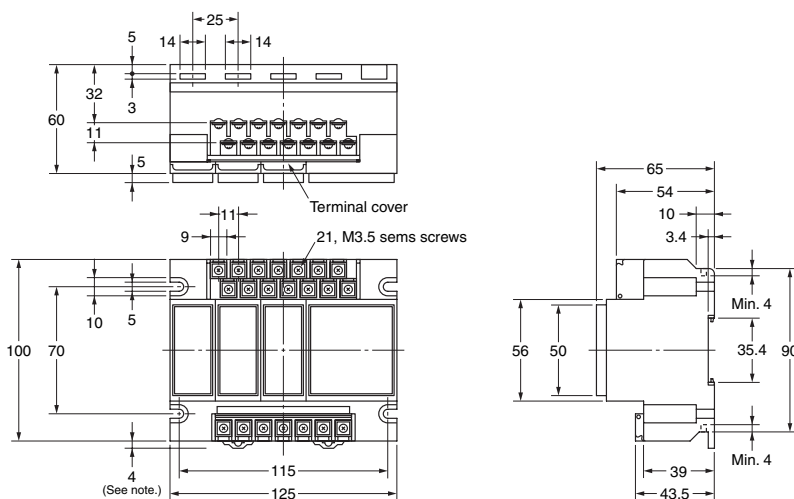
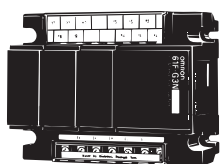

Note: Dimensions are with the DIN rail mounting (sliding) bracket attached.

61F-G4N, -G4NL, -G4NH, -G4ND, -G4NR, -G4N-KYD

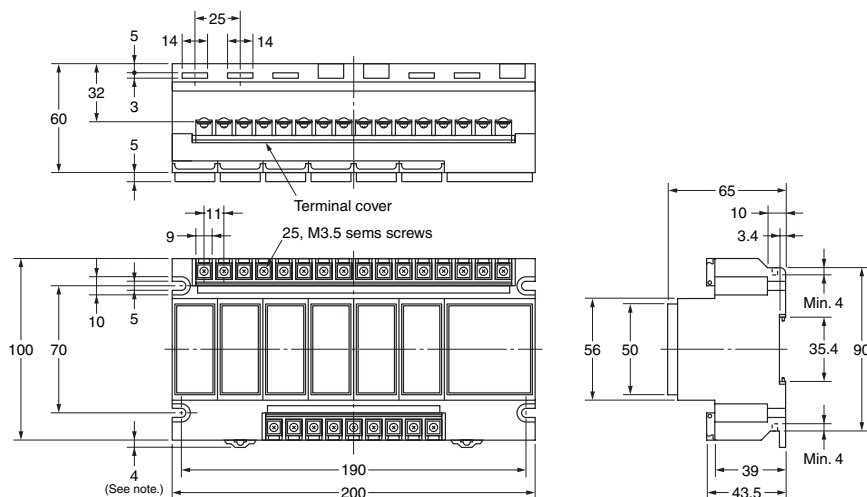
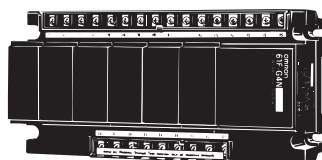

Note: Dimensions are with the DIN rail mounting (sliding) bracket attached.

■ Safety Precautions

Refer to *Safety Precautions for All Level Controllers*.

ALL DIMENSIONS SHOWN ARE IN MILLIMETERS.

To convert millimeters into inches, multiply by 0.03937. To convert grams into ounces, multiply by 0.03527.

In the interest of product improvement, specifications are subject to change without notice.

Terms and Conditions Agreement

Read and understand this catalog.

Please read and understand this catalog before purchasing the products. Please consult your OMRON representative if you have any questions or comments.

Warranties.

(a) Exclusive Warranty. Omron's exclusive warranty is that the Products will be free from defects in materials and workmanship for a period of twelve months from the date of sale by Omron (or such other period expressed in writing by Omron). Omron disclaims all other warranties, express or implied.

(b) Limitations. OMRON MAKES NO WARRANTY OR REPRESENTATION, EXPRESS OR IMPLIED, ABOUT NON-INFRINGEMENT, MERCHANTABILITY OR FITNESS FOR A PARTICULAR PURPOSE OF THE PRODUCTS. BUYER ACKNOWLEDGES THAT IT ALONE HAS DETERMINED THAT THE PRODUCTS WILL SUITABLY MEET THE REQUIREMENTS OF THEIR INTENDED USE.

Omron further disclaims all warranties and responsibility of any type for claims or expenses based on infringement by the Products or otherwise of any intellectual property right. (c) Buyer Remedy. Omron's sole obligation hereunder shall be, at Omron's election, to (i) replace (in the form originally shipped with Buyer responsible for labor charges for removal or replacement thereof) the non-complying Product, (ii) repair the non-complying Product, or (iii) repay or credit Buyer an amount equal to the purchase price of the non-complying Product; provided that in no event shall Omron be responsible for warranty, repair, indemnity or any other claims or expenses regarding the Products unless Omron's analysis confirms that the Products were properly handled, stored, installed and maintained and not subject to contamination, abuse, misuse or inappropriate modification. Return of any Products by Buyer must be approved in writing by Omron before shipment. Omron Companies shall not be liable for the suitability or unsuitability or the results from the use of Products in combination with any electrical or electronic components, circuits, system assemblies or any other materials or substances or environments. Any advice, recommendations or information given orally or in writing, are not to be construed as an amendment or addition to the above warranty.

See <http://www.omron.com/global/> or contact your Omron representative for published information.

Limitation on Liability: Etc.

OMRON COMPANIES SHALL NOT BE LIABLE FOR SPECIAL, INDIRECT, INCIDENTAL, OR CONSEQUENTIAL DAMAGES, LOSS OF PROFITS OR PRODUCTION OR COMMERCIAL LOSS IN ANY WAY CONNECTED WITH THE PRODUCTS, WHETHER SUCH CLAIM IS BASED IN CONTRACT, WARRANTY, NEGLIGENCE OR STRICT LIABILITY.

Further, in no event shall liability of Omron Companies exceed the individual price of the Product on which liability is asserted.

Suitability of Use.

Omron Companies shall not be responsible for conformity with any standards, codes or regulations which apply to the combination of the Product in the Buyer's application or use of the Product. At Buyer's request, Omron will provide applicable third party certification documents identifying ratings and limitations of use which apply to the Product. This information by itself is not sufficient for a complete determination of the suitability of the Product in combination with the end product, machine, system, or other application or use. Buyer shall be solely responsible for determining appropriateness of the particular Product with respect to Buyer's application, product or system. Buyer shall take application responsibility in all cases.

NEVER USE THE PRODUCT FOR AN APPLICATION INVOLVING SERIOUS RISK TO LIFE OR PROPERTY OR IN LARGE QUANTITIES WITHOUT ENSURING THAT THE SYSTEM AS A WHOLE HAS BEEN DESIGNED TO ADDRESS THE RISKS, AND THAT THE OMRON PRODUCT(S) IS PROPERLY RATED AND INSTALLED FOR THE INTENDED USE WITHIN THE OVERALL EQUIPMENT OR SYSTEM.

Programmable Products.

Omron Companies shall not be responsible for the user's programming of a programmable Product, or any consequence thereof.

Performance Data.

Data presented in Omron Company websites, catalogs and other materials is provided as a guide for the user in determining suitability and does not constitute a warranty. It may represent the result of Omron's test conditions, and the user must correlate it to actual application requirements. Actual performance is subject to the Omron's Warranty and Limitations of Liability.

Change in Specifications.

Product specifications and accessories may be changed at any time based on improvements and other reasons. It is our practice to change part numbers when published ratings or features are changed, or when significant construction changes are made. However, some specifications of the Product may be changed without any notice. When in doubt, special part numbers may be assigned to fix or establish key specifications for your application. Please consult with your Omron's representative at any time to confirm actual specifications of purchased Product.

Errors and Omissions.

Information presented by Omron Companies has been checked and is believed to be accurate; however, no responsibility is assumed for clerical, typographical or proofreading errors or omissions.