



Chipsmall Limited consists of a professional team with an average of over 10 year of expertise in the distribution of electronic components. Based in Hongkong, we have already established firm and mutual-benefit business relationships with customers from,Europe,America and south Asia,supplying obsolete and hard-to-find components to meet their specific needs.

With the principle of “Quality Parts,Customers Priority,Honest Operation,and Considerate Service”,our business mainly focus on the distribution of electronic components. Line cards we deal with include Microchip,ALPS,ROHM,Xilinx,Pulse,ON,Everlight and Freescale. Main products comprise IC,Modules,Potentiometer,IC Socket,Relay,Connector.Our parts cover such applications as commercial,industrial, and automotives areas.

We are looking forward to setting up business relationship with you and hope to provide you with the best service and solution. Let us make a better world for our industry!



## Contact us

Tel: +86-755-8981 8866 Fax: +86-755-8427 6832

Email & Skype: info@chipsmall.com Web: www.chipsmall.com

Address: A1208, Overseas Decoration Building, #122 Zhenhua RD., Futian, Shenzhen, China



# MINI-CON-X® FIELD INSTALLABLE CONNECTORS



**Cable Pin**  
6X8X-XPB-XXX  
**Matching Mates:**

- Cable-Cable  
8X8X-XSG-XXX
- Panel  
7XXX-XSG-XXX



**Panel Mount**  
7X8X-XXG-XXX  
**Matching Mates:**

- Cable Pin  
6X8X-XPB-XXX
- Cable Socket  
6X8X-XSG-XXX



**P/C Tail Panel Mount**  
7XXX-XXG-XXX  
**Matching Mates:**

- Cable Pin  
6X8X-XPB-XXX
- Cable Socket  
6X8X-XSG-XXX



**Cable Socket**  
6X8X-XSG-XXX  
**Matching Mates:**

- Cable-Cable  
8X8X-XPB-XXX
- Panel  
7XXX-XPB-XXX



**Cable to Cable**  
8X8X-XXG-XXX  
**Matching Mates:**

- Cable Pin  
6X8X-XPB-XXX
- Cable Socket  
6X8X-XSG-XXX



**Dust Cap**  
6295



**Winged Coupling Ring**  
W/6482

## Molded Cable Assemblies (See pages 3 & 26)



**Cable End**



**Cable to Cable**



**Right Angle**

# MINI-CON-X® FIELD INSTALLABLE CONNECTORS

## Dimensions

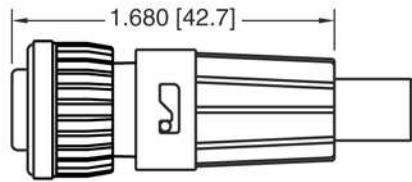
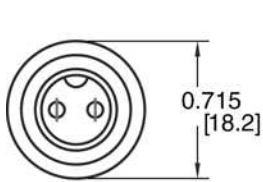

**CABLE END CONNECTOR**  
STYLE 5 LONG  
TWIST LOCK BACKSHELL

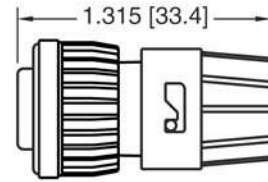

**CABLE END CONNECTOR**  
STYLE 3 AND 3DC SHORT  
TWIST LOCK BACKSHELL

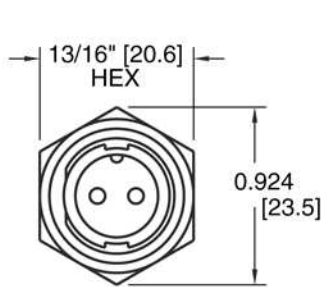

5/8" [15.9]-27 UNEF THREAD  
1/32" TO 3/16" PANEL  
[0.8 TO 4.8]

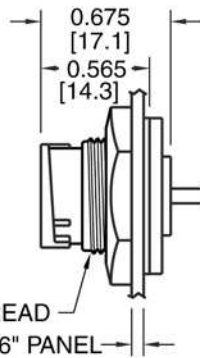

**PANEL MOUNT CONNECTOR**  
SHOWN WITH HEX NUT AND GASKET

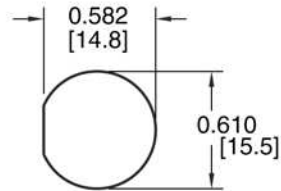

RECOMMENDED  
PANEL CUT-OUT  
±.003 [±0.1]

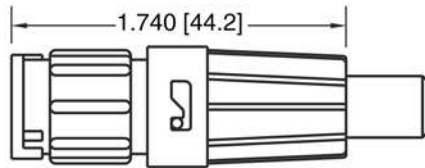
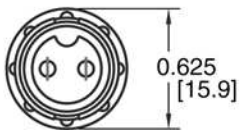

**CABLE TO CABLE CONNECTOR**  
STYLE 5 LONG  
TWIST LOCK BACKSHELL

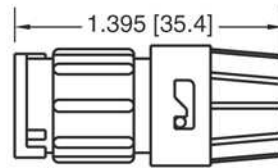

**CABLE TO CABLE CONNECTOR**  
STYLE 3 AND 3DC SHORT  
TWIST LOCK BACKSHELL

## Molded Cable Assemblies (See pages 3 & 26)

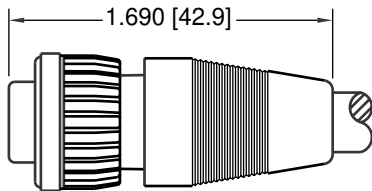

**CABLE END ASSEMBLY**  
STRAIGHT BOOT  
0.375 [9.5] MAX. CABLE O.D.

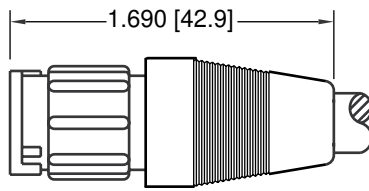

**CABLE TO CABLE ASSEMBLY**  
STRAIGHT BOOT  
0.375 [9.5] MAX. CABLE O.D.

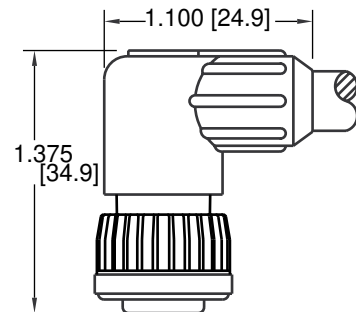

**CABLE END ASSEMBLY**  
90° BOOT  
0.310 [7.9] MAX. CABLE O.D.

# MINI-CON-X® FIELD INSTALLABLE CONNECTORS

## Part Number to Order

**X X XX-XXG-XXX**

**Connector Type:** \_\_\_\_\_

- 6 - Cable End
- 7 - Panel Mount
- 8 - Cable to Cable

**Contact Size:** \_\_\_\_\_

- 2 - #20 (2-8 Contacts)
- 3 - #16 (2-5 Contacts)

**Contact Style:** \_\_\_\_\_

- 80 - Crimp (Supplied loose)
- 81 - P/C Tail .187" (4.7) (Supplied assembled)
- 82 - Solder Cup (Supplied assembled)
- 91 - P/C Tail .280" (7.1) (Supplied assembled)\*
- 92 - P/C Tail .335" (8.5) (Supplied assembled)\*

**Number of Contacts:** \_\_\_\_\_

- 2, 3, 4, 5, 6, 7 & 8

**Type of Contact:** \_\_\_\_\_

- P - Pin
- S - Socket

**Contact Plating:** \_\_\_\_\_

- G - Gold over Nickel (Standard)

**Grommet Code -**

**Cable O.D. Range:**

- 11 - .09 - .14 (2.3 - 3.5)
- 15 - .15 - .17 (3.8 - 4.3)
- 18 - .18 - .20 (4.6 - 5.1)
- 21 - .21 - .23 (5.3 - 5.8)

**Back Shell Style 3**

**Back Shell Style 5**

- 13 - .13 - .15 (3.3 - 3.8)
- 16 - .16 - .18 (4.1 - 4.6)
- 19 - .19 - .21 (4.8 - 5.3)
- 22 - .22 - .25 (5.6 - 6.3)

**Back Shell Style:**

- 3 Weathertight grommet grip/seal & (1) interfacial "O" ring.
- 3DC - Daisy chain grommet with 3 I.D.s. (.125, .188 & .250)
- 5 Long back shell with extended grommet & cable grip. Use with crimp or solder.
- 300 - Panel mount with hex nut & gasket.
- 3ES - 300 with Epoxy

\*Available in #20 size contact only.

Consult factory for optional threaded coupling.

Consult factory for your custom design cable assemblies and connectors. (See pages 3 & 26)

## Contact Arrangements

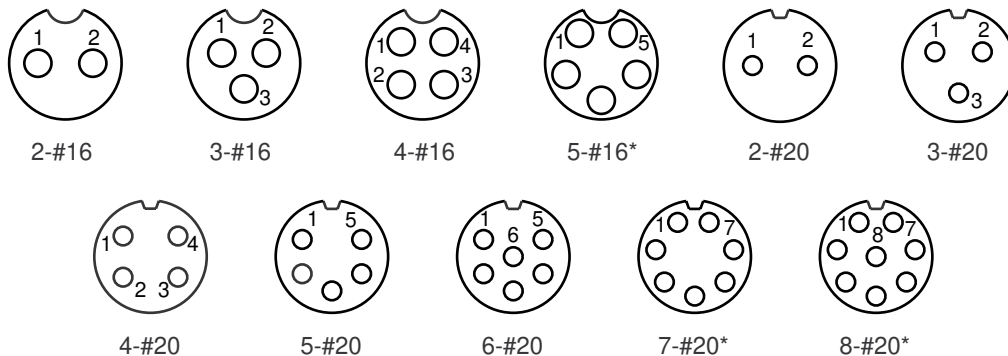

Contact arrangements shown are wiring view of cable end pins/sockets.

Key/keyway shown for orientation only.

\*Available in connector types: cable end socket, panel mount pin, and cable to cable pin styles only.

# MINI-CON-X® FIELD INSTALLABLE CONNECTORS

## Specifications

### Typical Specifications

Manufacturers Identifications	Mini-Con-X®
Description	Field Installable Connector & Custom Cable Assemblies
Rating	4.8 thru 13.0A, 600V
Conductor Size	#16 contacts, 16 thru 18 AWG #20 contacts, 20 thru 24 AWG
Configuration	2 thru 5 #16 Contacts or 2 thru 8 #20 Contacts
Certification	UL Recognized File #E138878 - 250V CSA Certified File #LR89277 - 600V

### Material Specifications

#### Cable Pin/Socket

Backshell (Removable Twist Lock)	Nylon, UL Recognized, Black
Grommet	Santoprene Rubber, Black
Coupling Ring	Nylon, UL Recognized, Black
Contacts	Brass, Gold over Nickel
Connector Body	Nylon, UL Recognized, Black
O-Ring	Nitrile Rubber, Black

#### Optional

Long Backshell (Removable Twist Lock)	Nylon, UL Recognized, Black (Style #5)
Winged Coupling Ring	Nylon, UL Recognized, Black (W/6482)

#### Cable to Cable

Backshell (Removable Twist Lock)	Nylon, UL Recognized, Black
Grommet	Santoprene Rubber, Black
Contacts	Brass, Gold over Nickel
Connector Body	Nylon, UL Recognized, Black

#### Panel Mount

Contacts	Brass, Gold over Nickel
Panel Body	Nylon, UL Recognized, Black
Gasket	Nitrile Rubber, Black
Hex Nut	Nylon, UL Recognized, Black

#### Optional

Dust Cap	Santoprene Rubber, Black (Part No. 6295)
----------	--

### Mechanical Specifications

Durability	Minimum 300 mate/unmate cycles without mechanical or electrical failure
Vibration	Coupling rings have overriding locking feature to prevent loosening or separation of connector
Hex Nut Torque	All series hex nut to withstand 10-12 inch/lb tightening torque

### Electrical Specifications

Voltage	600 V
Current	See Electrical Current Rating Chart (Page 27)

### Environmental Specifications

Temperature Rating	-55°C to +125°C (-67°F to +257°F)
Corrosion	300 Hr salt spray contacts
Weatheright	Consult factory with specific application

### Molded Cable Assemblies

Watertight	(See Pages 3 & 26) NEMA 6P, 13: IEC IP67
------------	---