



Chipsmall Limited consists of a professional team with an average of over 10 year of expertise in the distribution of electronic components. Based in Hongkong, we have already established firm and mutual-benefit business relationships with customers from,Europe,America and south Asia,supplying obsolete and hard-to-find components to meet their specific needs.

With the principle of “Quality Parts,Customers Priority,Honest Operation,and Considerate Service”,our business mainly focus on the distribution of electronic components. Line cards we deal with include Microchip,ALPS,ROHM,Xilinx,Pulse,ON,Everlight and Freescale. Main products comprise IC,Modules,Potentiometer,IC Socket,Relay,Connector.Our parts cover such applications as commercial,industrial, and automotives areas.

We are looking forward to setting up business relationship with you and hope to provide you with the best service and solution. Let us make a better world for our industry!



Contact us

Tel: +86-755-8981 8866 Fax: +86-755-8427 6832

Email & Skype: info@chipsmall.com Web: www.chipsmall.com

Address: A1208, Overseas Decoration Building, #122 Zhenhua RD., Futian, Shenzhen, China



THIS IS A CAD GENERATED DRAWING
DO NOT MAKE MANUAL REVISIONS TO MASTER.

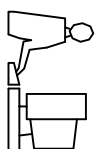

ISSUE NUMBER	ORIGINAL
①	
ADD PANEL CUT-OUT DIMENSION	AUG9/2016
②	

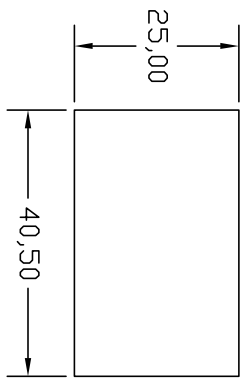
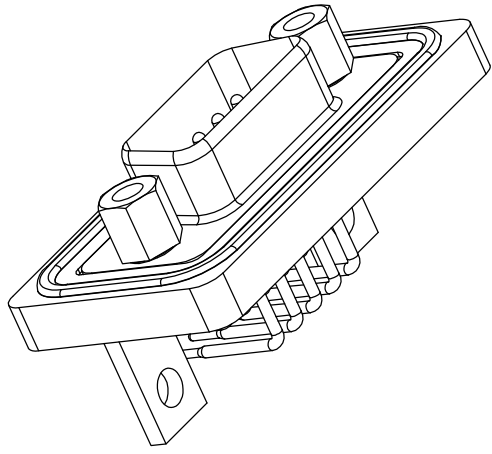
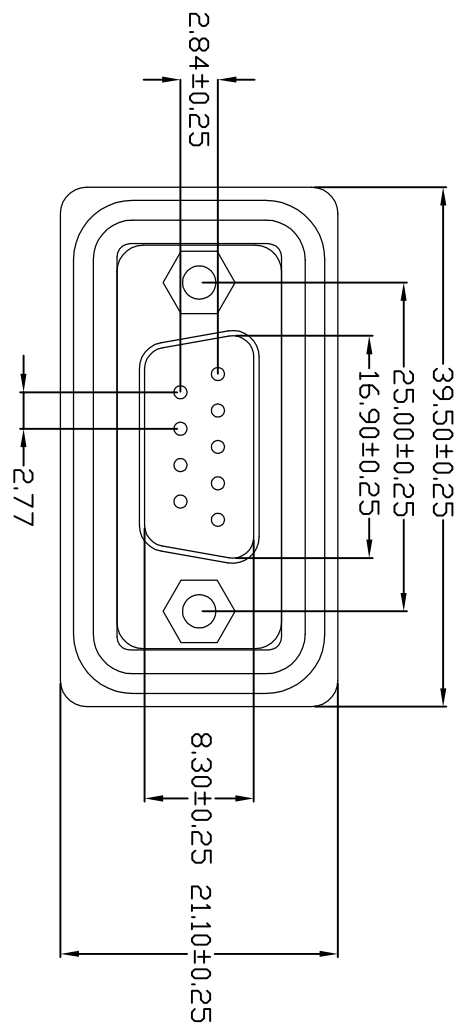

RECOMMENDED PANEL CUT OUT
MAXIMUM PANEL THICKNESS: 2.00MM

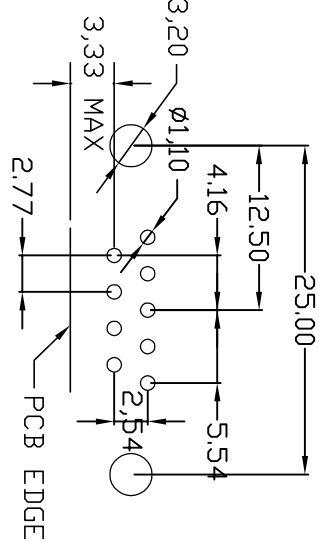
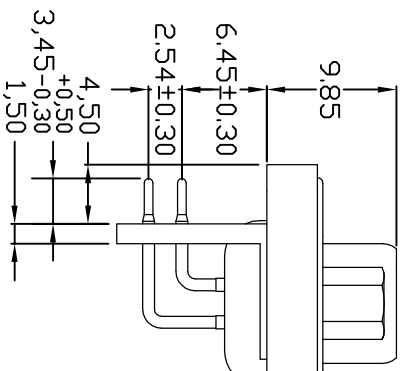
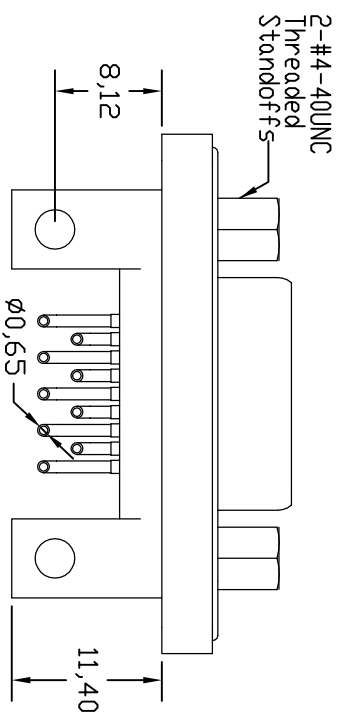

Mounting Option
2- #4-40 UNC THREADED HOLE
Contact Code
40- RIGHT ANGLE TAIL, 10.3 L4061, STANDARD FOOTPRINT

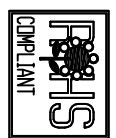

THIS SERIES FULLY CONFORMS TO THE
EUROPEAN UNION DIRECTIVES
2011/65/EU FOR ROHS COMPLIANCY.

- Materials and Finish**
- Insulator: PBT with Glass Fiber, UL94V-0, Black
 - Shell: Steel, Nickel Plated
 - Contact: Copper Alloy, with 2-Gold Flash Plating over Nickel
 - Watertight Frame: PBT with Glass Fiber, UL94V-0, Black
 - O-Ring: Silicone
 - Epoxy Sealant: Epoxy
- DEGREE OF PROTECTION: IP67 AS PER IEC60529**
- Electrical Characteristics**
- Current Rating: 5 Amperes
 - Dielectric Withstanding Voltage: 1000 V, for 1 Minute
 - Insulation Resistance: 5000 Megohm Min.
 - Contact Resistance: 10 Milliohms Max.
 - Temperature Range: -25C to +85C

Standard Density Waterproof D-Sub Connector

PART NUMBER: 629-W09-240-015

PLUG

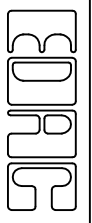

EDAC INC
TORONTO, ONTARIO
CANADA

YOUR CONNECTION TO QUALITY & SERVICE

THESE DRAWINGS AND SPECIFICATIONS ARE THE PROPERTY OF EDAC INC. AND SHALL NOT BE REPRODUCED OR USED AS THE BASIS FOR THE MANUFACTURE OR SALE OF APPARATUS WITHOUT WRITTEN PERMISSION.

ACAD REFERENCE NO. 627-629W Assembly

DRAWN: RSTAMONDICA DATE: June 4/13

CHECKED: DATE:

SCALE: NTS SHEET 1 OF 1

DRAWING NUMBER 627-629W Assembly

ISSUE 2