



Chipsmall Limited consists of a professional team with an average of over 10 year of expertise in the distribution of electronic components. Based in Hongkong, we have already established firm and mutual-benefit business relationships with customers from,Europe,America and south Asia,supplying obsolete and hard-to-find components to meet their specific needs.

With the principle of “Quality Parts,Customers Priority,Honest Operation,and Considerate Service”,our business mainly focus on the distribution of electronic components. Line cards we deal with include Microchip,ALPS,ROHM,Xilinx,Pulse,ON,Everlight and Freescale. Main products comprise IC,Modules,Potentiometer,IC Socket,Relay,Connector.Our parts cover such applications as commercial,industrial, and automotives areas.

We are looking forward to setting up business relationship with you and hope to provide you with the best service and solution. Let us make a better world for our industry!



Contact us

Tel: +86-755-8981 8866 Fax: +86-755-8427 6832

Email & Skype: info@chipsmall.com Web: www.chipsmall.com

Address: A1208, Overseas Decoration Building, #122 Zhenhua RD., Futian, Shenzhen, China



Technical Data Sheet

Luminosity Full Color LED

64-03/R6SGHBHC-B01/2T

Features

- Super-luminosity chip LED.
- White SMT package with black surface.
- Built in Red, Green, and Blue chips.
- Lead frame package with individual 6 pins.
- Wide viewing angle.
- Soldering methods: IR reflow soldering.
- Pb-free.
- The product itself will remain within RoHS compliant version.

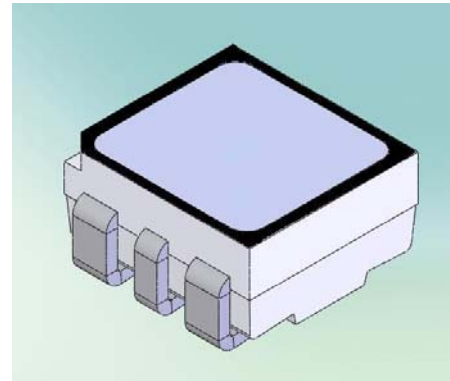

Descriptions

- Due to the package design, 64-03 has wide viewing angle , low power consumption and adjusting each color is possible thanks to serial connection by 6 terminal connection (Individual driving by each terminal) in case of using several number of LED. And makes it ideal for light pipe application.

Applications

- Amusement equipment.
- Information boards.
- Flashlight for digital camera of cellular phone.

Device Selection Guide

Chip		Emitted Color	Resin Color
Type	Material		
R6S	AlGaInP	Brilliant Red	Water Clear
GH	InGaN	Brilliant Green	
BH	InGaN	Blue	

Technical Data Sheet

Luminosity Full Color LED

64-03/R6SGHBHC-B01/2T

Package Outline Dimension

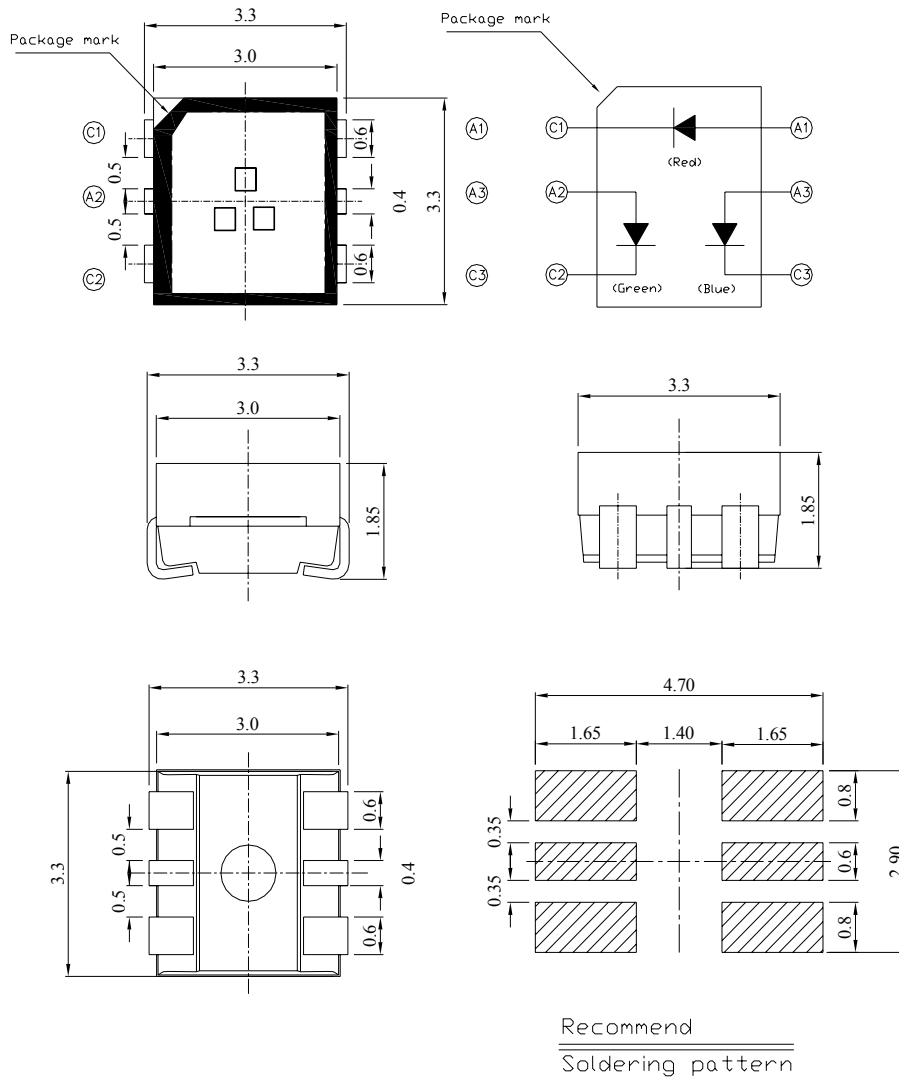

Notes:

- 1.All dimensions are in millimeters.
- 2.Tolerances unspecified are ± 0.1 mm.



Technical Data Sheet

Luminosity Full Color LED

64-03/R6SGHBHC-B01/2T

Absolute Maximum Ratings (Ta=25°C)

Parameter	Symbol	Rating		Unit
Reverse Voltage	V _R	5		V
Forward Current	I _F	R6S	50	mA
		GH	25	
		BH	25	
Peak Forward Current(Duty 1/10 @ 1KHZ)	I _{FP}	R6S	100	mA
		GH	100	
		BH	100	
Power Dissipation	P _d	R6S	120	mW
		GH	110	
		BH	110	
Electrostatic Discharge(HBM)	ESD	R6S	2000	V
		GH	150	
		BH	150	
Heat Thermal Resistance	R _{th j-s}	R6S	200	°C/W
		GB	200	
		BH	200	
Operating Temperature	Topr	-40 ~ +85		°C
Storage Temperature	Tstg	-40 ~ +90		°C
Soldering Temperature	Tsol	Reflow Soldering : 260 °C for 10 sec. Hand Soldering : 350 °C for 3 sec.		

Technical Data Sheet

Luminosity Full Color LED

64-03/R6SGHBHC-B01/2T

Electro-Optical Characteristics (Ta=25°C)

Parameter	Symbol	Min.	Typ.	Max.	Unit	Condition	
Luminous Intensity	I _v	R6S	112	-----	285	mcd	I _F =20mA
		GH	285	-----	715		I _F =20mA
		BH	112	-----	285		I _F =20mA
Viewing Angle	2θ _{1/2}	-----	120	-----	deg	I _F =20mA	
Peak Wavelength	λ _p	R6S	-----	632	-----	nm	I _F =20mA
		GH	-----	518	-----		
		BH	-----	468	-----		
Dominant Wavelength	λ _d	R6S	621	-----	631	nm	I _F =20mA
		GH	520	-----	530		
		BH	465	-----	470		
Spectrum Radiation Bandwidth	Δλ	R6S	-----	20	-----	nm	I _F =20mA
		GH	-----	35	-----		
		BH	-----	35	-----		
Forward Voltage	V _F	R6S	-----	2.0	2.4	V	I _F =20mA
		GH	-----	3.5	4.0		
		BH	-----	3.5	4.0		
Reverse Current	I _R	R6S	-----	-----	10	μA	V _R =5V
		GH	-----	-----	50		
		BH	-----	-----	50		

Notes:

1. Tolerance of Luminous Intensity ±11%
2. Tolerance of Dominant Wavelength ±1 nm
3. Tolerance of Forward Voltage ±0.1V



Technical Data Sheet

Luminosity Full Color LED

64-03/R6SGHBHC-B01/2T**Bin Range Of Luminous Intensity**

Symbol		Bin Code	Min.	Max.	Unit	Condition
I _v	R6S	R	112	180	mcd	I _F =20mA
		S	180	285		
	GH	T	285	450		
		U	450	715		
	BH	R	112	180		
		S	180	285		

Bin Range Of Dominant Wavelength

Symbol		Bin Code	Min.	Max.	Unit	Condition
λ _d	R6S	FF1	621	626	nm	I _F =20mA
		FF2	626	631		
	GH	X	520	525		
		Y	525	530		
	BH	X	465	470		

Notes:

1. Tolerance of Luminous Intensity $\pm 11\%$
2. Tolerance of Dominant Wavelength ± 1 nm



Technical Data Sheet

Luminosity Full Color LED

64-03/R6SGHBHC-B01/2T

Chromaticity Coordinates Specifications for Bin Grading

R6S		Rank				Condition
Chromaticity Coordinates	x	0.674	0.648	0.677	0.708	I _F =20mA
	y	0.296	0.323	0.323	0.292	

GB		Rank						Condition
Chromaticity Coordinates	x	0.166	0.136	0.176	0.220	0.237	0.201	I _F =20mA
	y	0.676	0.739	0.750	0.745	0.684	0.686	

BH		Rank						Condition
Chromaticity Coordinates	x	0.139	0.129	0.113	0.134	0.145	0.152	I _F =20mA
	y	0.035	0.050	0.080	0.105	0.072	0.056	

*The C.I.E. 1931 chromaticity diagram (Tolerance ±0.01).

Technical Data Sheet

Luminosity Full Color LED

64-03/R6SGHBHC-B01/2T

CIE Chromaticity Diagram of R.G.B

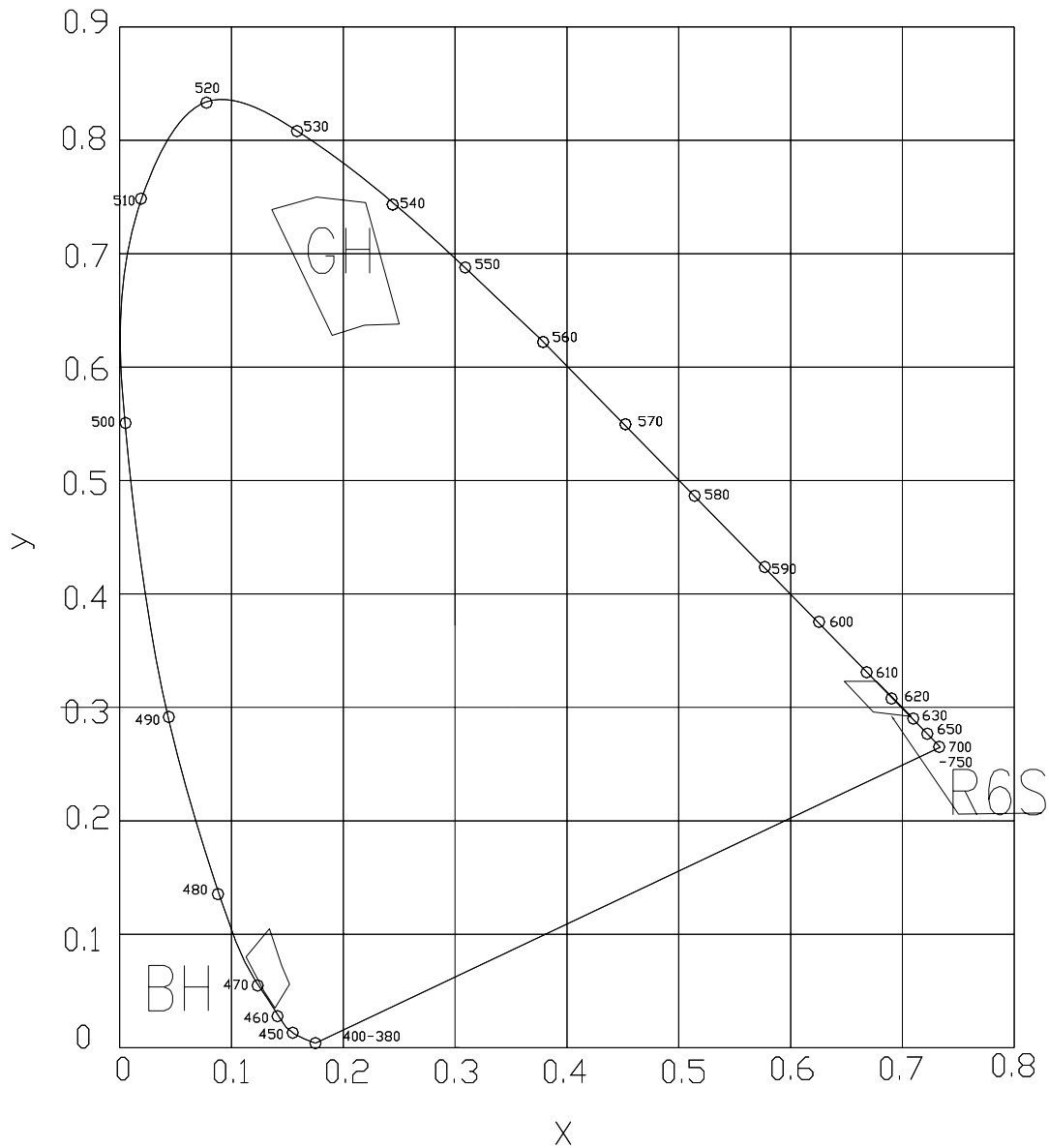

*Only for reference

Technical Data Sheet

Luminosity Full Color LED

64-03/R6SGHBHC-B01/2T

Typical Electro-Optical Characteristics Curves (R6S)

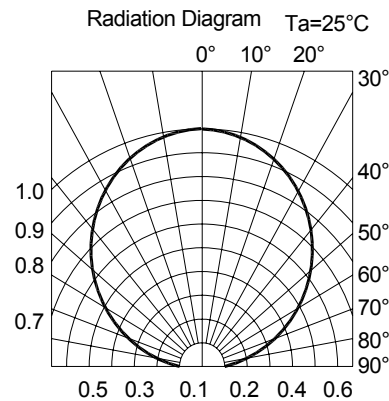
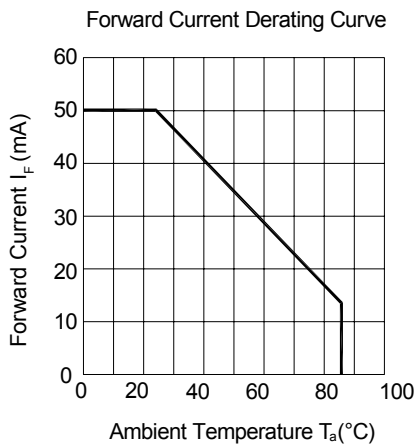
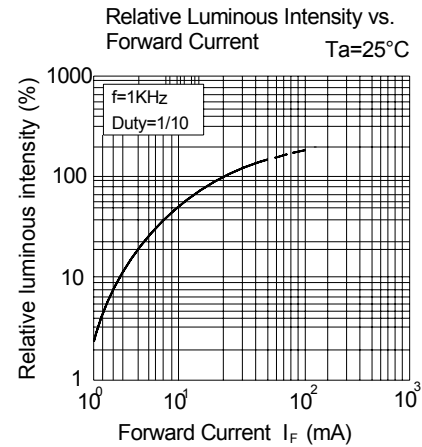
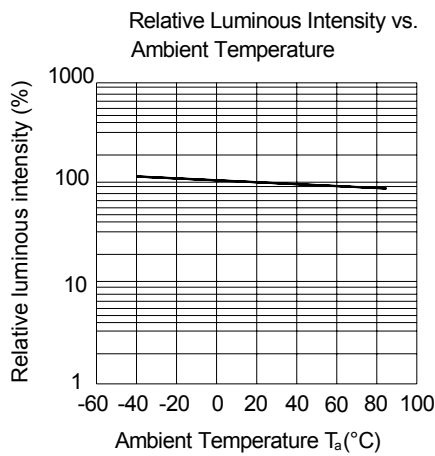
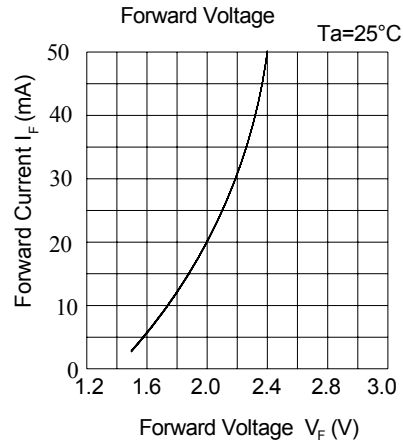
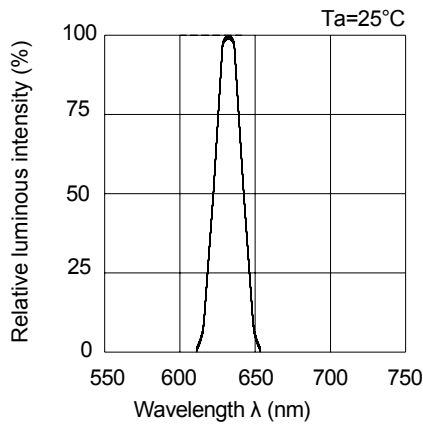

Technical Data Sheet

Luminosity Full Color LED

64-03/R6SGHBHC-B01/2T

Typical Electro-Optical Characteristics Curves (GH)

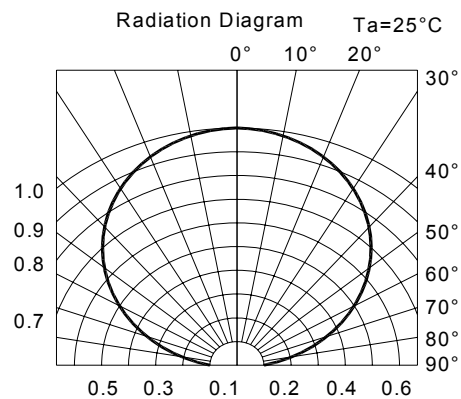
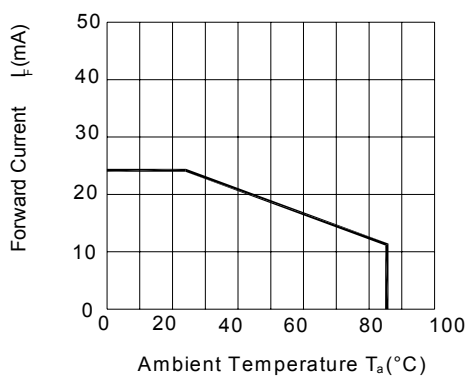
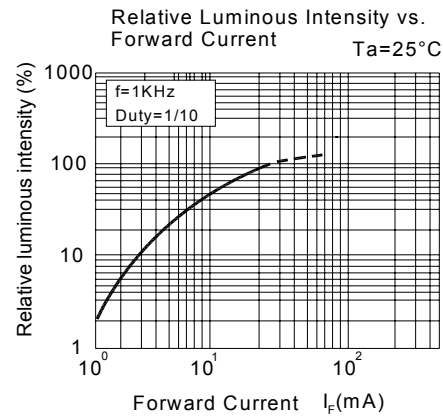
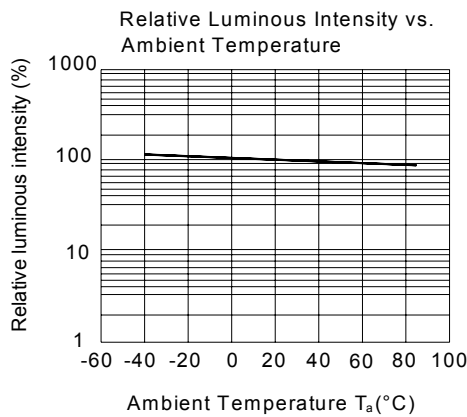
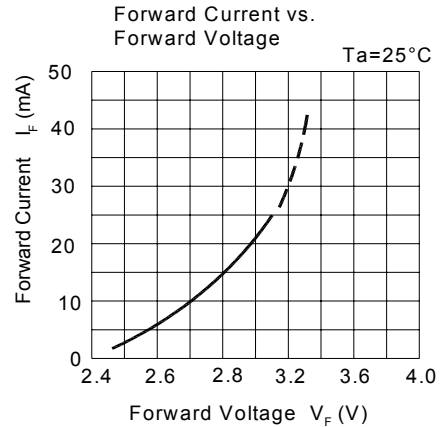
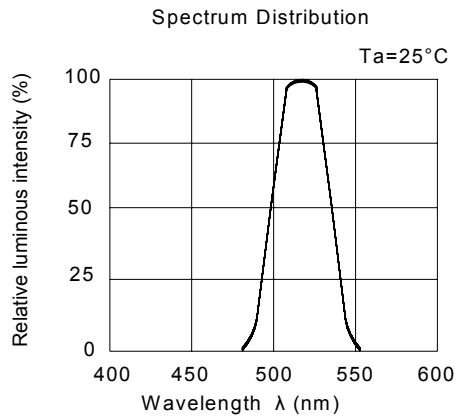

Technical Data Sheet

Luminosity Full Color LED

64-03/R6SGHBHC-B01/2T

Typical Electro-Optical Characteristics Curves (BH)

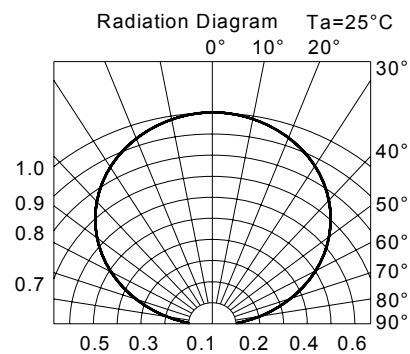
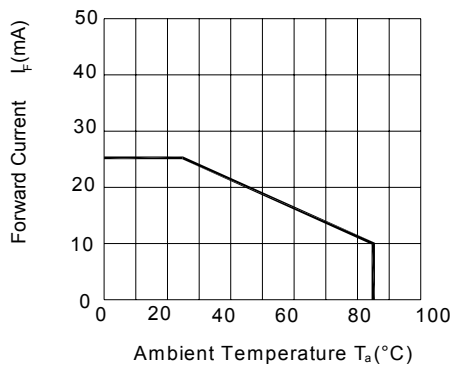
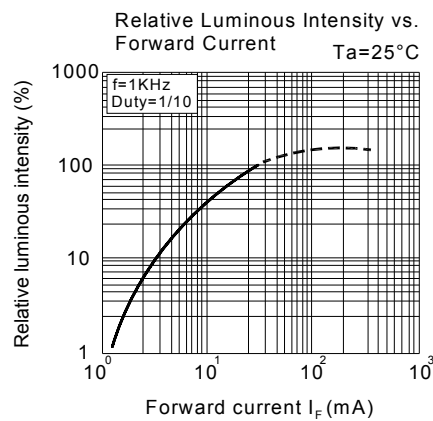
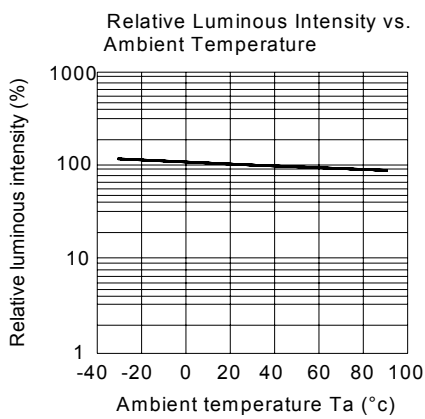
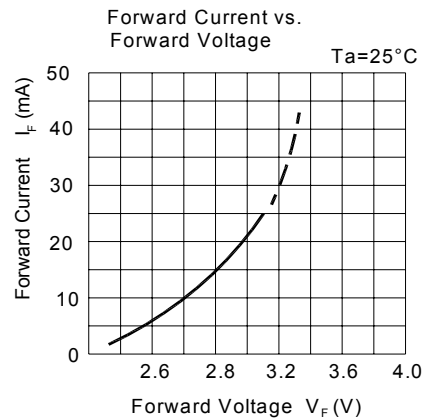
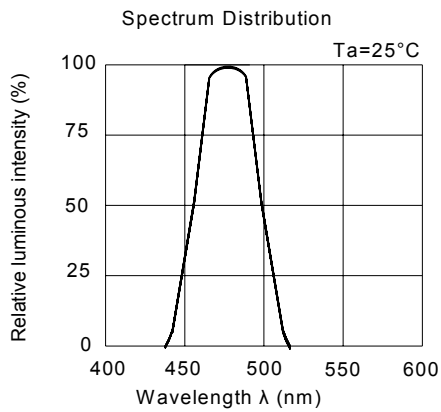



Technical Data Sheet

Luminosity Full Color LED

64-03/R6SGHBHC-B01/2T

Label Explanation

CAT: Luminous Intensity Rank

HUE: Dom. Wavelength Rank

REF: Forward Voltage Rank

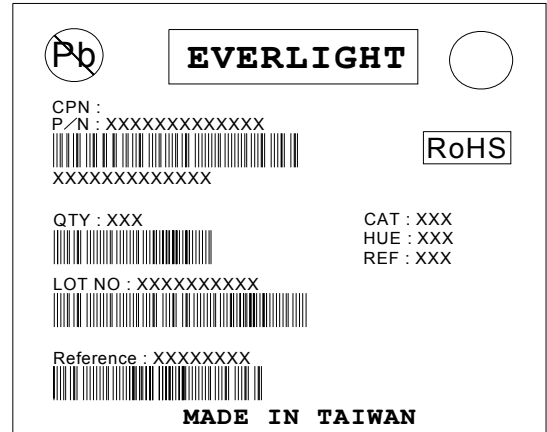

Reel Dimensions

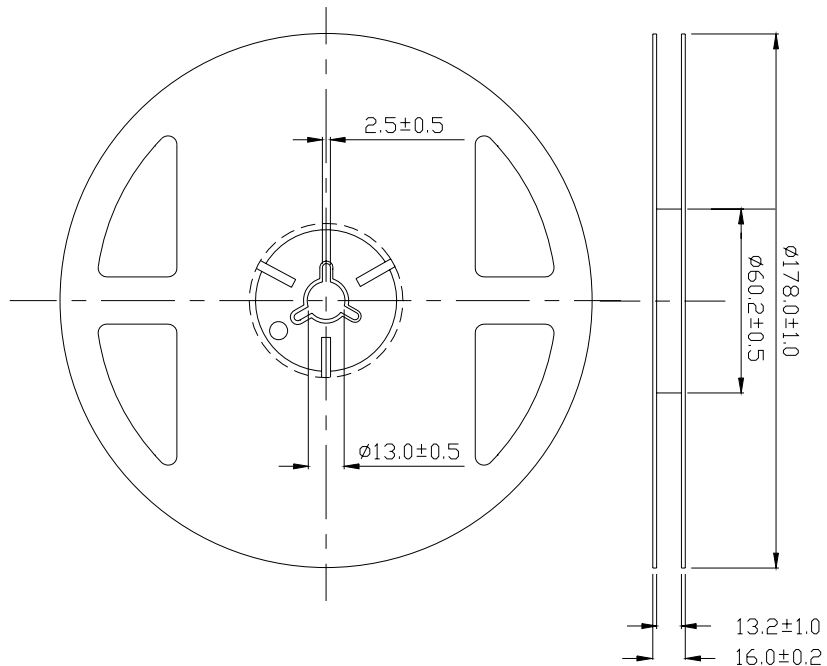

Note: The tolerances unless mentioned is ± 0.1 mm ,Unit = mm

Technical Data Sheet

Luminosity Full Color LED

64-03/R6SGHBHC-B01/2T

Carrier Tape Dimensions: Loaded Quantity 2000 pcs Per Reel

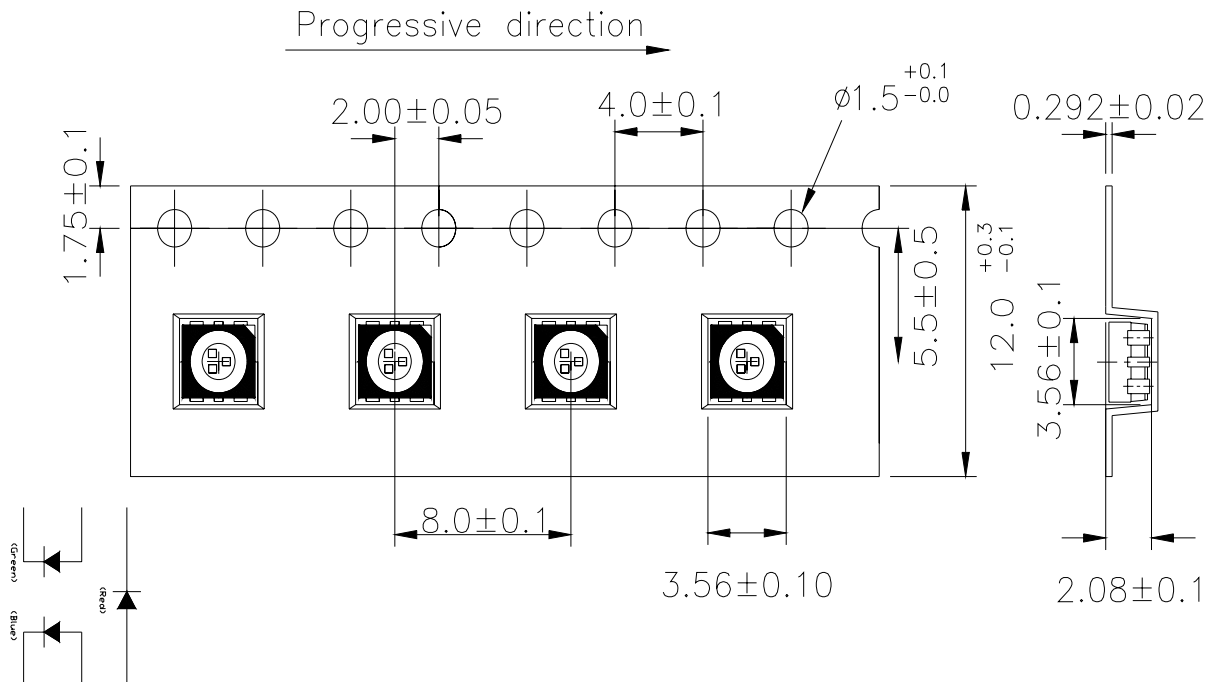

Note: The tolerances unless mentioned is $\pm 0.1\text{mm}$, Unit = mm

Moisture Resistant Packaging Process and Materials

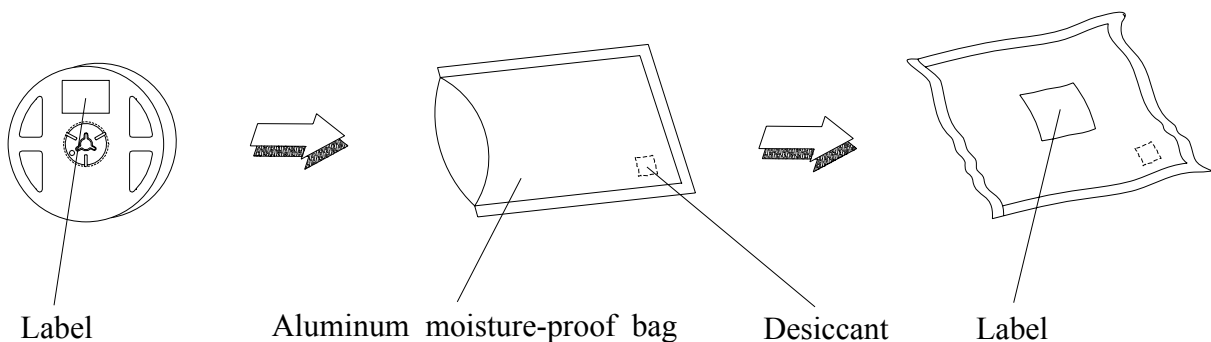



Technical Data Sheet

Luminosity Full Color LED

64-03/R6SGHBHC-B01/2T**Reliability Test Items and Conditions**

The reliability of products shall be satisfied with items listed below.

Confidence level : 90%

LTPD : 10%

No.	Items	Test Condition	Test Hours/Cycles	Sample Size	Ac/Re
1	Reflow Soldering	Temp. : 260°C±5°C Min. 5sec.	6 Min.	22 PCS.	0/1
2	Temperature Cycle	H : +100°C 15min ∫ 5 min L : -40°C 15min	300 Cycles	22 PCS.	0/1
3	Thermal Shock	H : +100°C 5min ∫ 10 sec L : -10°C 5min	300 Cycles	22 PCS.	0/1
4	High Temperature Storage	Temp. : 100°C	1000 Hrs.	22 PCS.	0/1
5	Low Temperature Storage	Temp. : -40°C	1000 Hrs.	22 PCS.	0/1
6	DC Operating Life*	I _F = 20 mA	1000 Hrs.	22 PCS.	0/1
7	High Temperature / High Humidity	85°C/ 85%RH	1000 Hrs.	22 PCS.	0/1

* For each die

Technical Data Sheet

Luminosity Full Color LED

64-03/R6SGHBHC-B01/2T**Precautions For Use**

1. Over-current-proof

Customer must apply resistors for protection, otherwise slight voltage shift will cause big current change (Burn out will happen).

2. Storage

2.1 Do not open moisture proof bag before the products are ready to use.

2.2 Before opening the package: The LEDs should be kept at 30°C or less and 90%RH or less.

2.3 After opening the package: The LED's floor life is 1 year under 30°C or less and 60% RH or less.

If unused LEDs remain, it should be stored in moisture proof packages.

2.4 If the moisture absorbent material (silica gel) has faded away or the LEDs have exceeded the storage time, baking treatment should be performed using the following conditions.

Baking treatment : 60±5°C for 24 hours.

3. Soldering Condition

3.1 Pb-free solder temperature profile

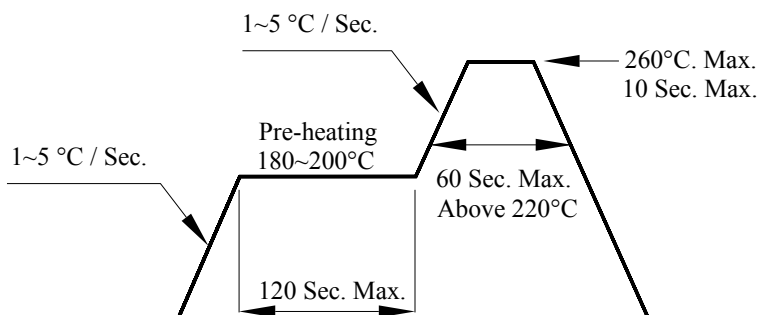

3.2 Reflow soldering should not be done more than two times.

3.3 When soldering, do not put stress on the LEDs during heating.

3.4 After soldering, do not warp the circuit board.

Technical Data Sheet

Luminosity Full Color LED

64-03/R6SGHBHC-B01/2T

4. Soldering Iron

Each terminal is to go to the tip of soldering iron temperature less than 350°C for 3 seconds within once in less than the soldering iron capacity 25W. Leave two seconds and more intervals, and do soldering of each terminal. Be careful because the damage of the product is often started at the time of the hand solder.

5. Repairing

Repair should not be done after the LEDs have been soldered. When repairing is unavoidable, a double-head soldering iron should be used (as below figure). It should be confirmed beforehand whether the characteristics of the LEDs will or will not be damaged by repairing.

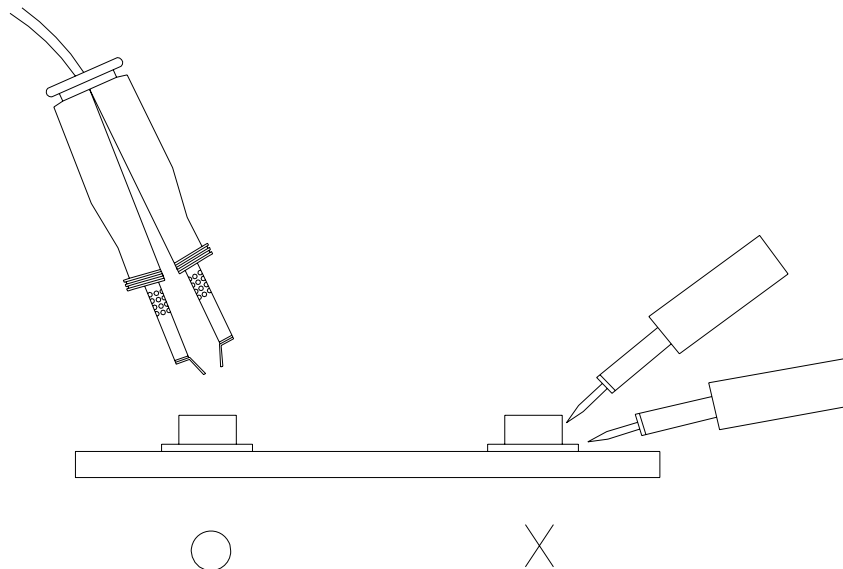

EVERLIGHT ELECTRONICS CO., LTD.
Office: No 25, Lane 76, Sec 3, Chung Yang Rd,
Tucheng, Taipei 236, Taiwan, R.O.C

Tel: 886-2-2267-2000, 2267-9936
Fax: 886-2267-6244, 2267-6189, 2267-6306
<http://www.everlight.com>