



Chipsmall Limited consists of a professional team with an average of over 10 year of expertise in the distribution of electronic components. Based in Hongkong, we have already established firm and mutual-benefit business relationships with customers from,Europe,America and south Asia,supplying obsolete and hard-to-find components to meet their specific needs.

With the principle of “Quality Parts,Customers Priority,Honest Operation,and Considerate Service”,our business mainly focus on the distribution of electronic components. Line cards we deal with include Microchip,ALPS,ROHM,Xilinx,Pulse,ON,Everlight and Freescale. Main products comprise IC,Modules,Potentiometer,IC Socket,Relay,Connector.Our parts cover such applications as commercial,industrial, and automotives areas.

We are looking forward to setting up business relationship with you and hope to provide you with the best service and solution. Let us make a better world for our industry!



## Contact us

Tel: +86-755-8981 8866 Fax: +86-755-8427 6832

Email & Skype: info@chipsmall.com Web: www.chipsmall.com

Address: A1208, Overseas Decoration Building, #122 Zhenhua RD., Futian, Shenzhen, China



Tous droits strictement reserves. Reproduction ou communication a des tiers interdite sous quelque forme que ce soit sans autorisation ecrite du proprietaire. Propriete de c FCI. Droits de reproduction FCI.

All rights strictly reserved. Reproduction or issue to third parties in any form whatever is not permitted without written authority from the proprietor. Property of FCI. Copyright FCI.

PRODUCT NO.  
SEE TABLE

STYLE P  
SHOWN THIS SHEET

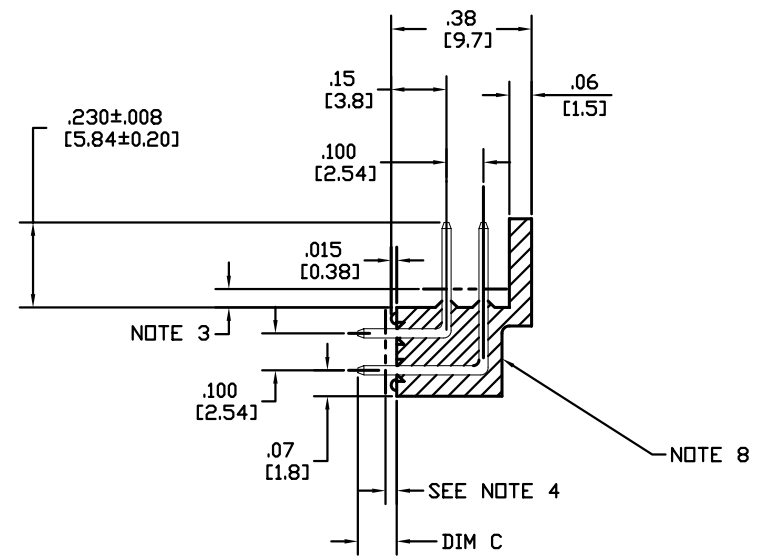
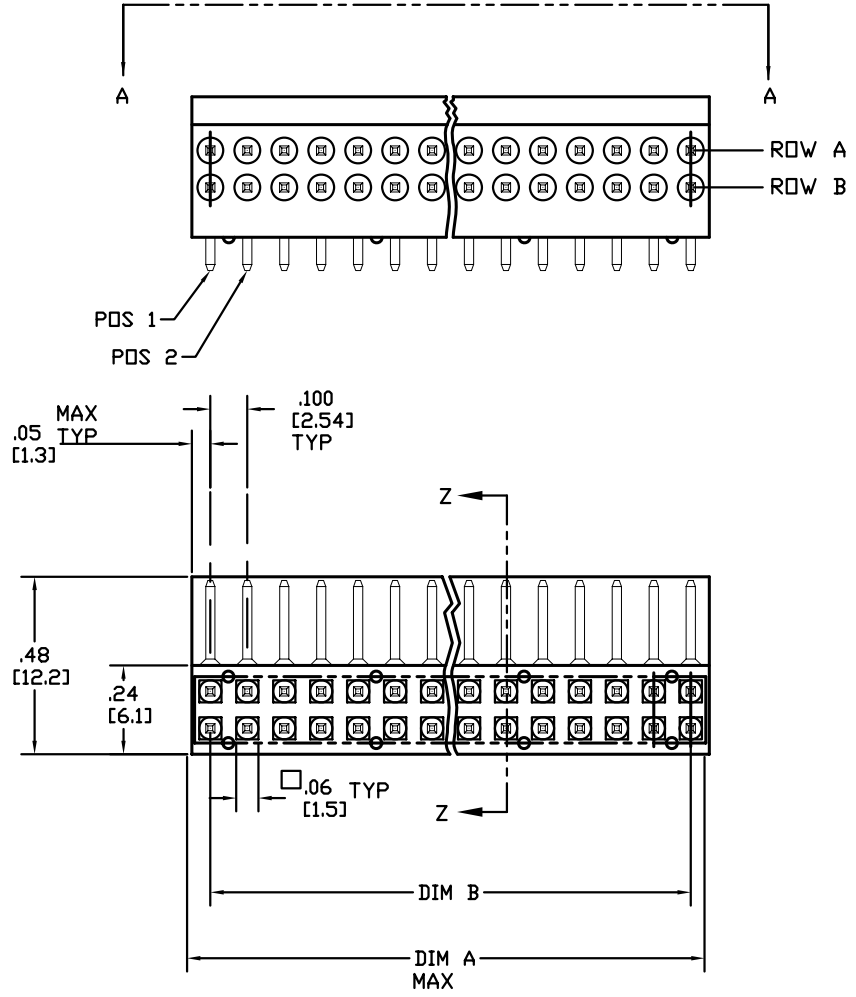

SECTION Z-Z

mat'l. code				tolerances unless otherwise specified				CUSTOMER COPY		FCI		www.fciconnect.com	
NOTE 1													
ltr	ecn no	dr	date	linear	.XX±.01/.X±.3				projection	title			
AJ	?????	RLS	3-29-90		.XXX±.005/.XX±.13					TOP SHIELDED RIGHT ANGLE HEADER			
AK	V03-0413	GJP	4-14-03		.XXX±.0020/.XXX±.051					product family HEADERS			
AL	V05-0891	DAI	10/10/05		0° ±2'					code 213			
				angles	0° ±2'				INCH/MM		size		sheet 1 of 4
				dr	R SEIPLE	3-30-90		scale		A		65461	
				engr	H SUNDY	3-30-90							
				chr	H SUNDY	3-30-90							
				appd	H SUNDY	3-30-90							
sheet index	revision sheet	AL 1	AL 2	AL 3	AL 4								

PRODUCT NO.  
SEE TABLE

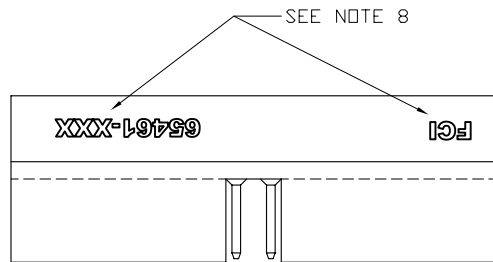

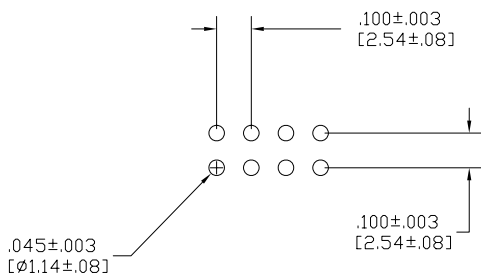

**VIEW A-A  
STYLE M  
SCALE 5:1**



**RECOMMENDED HOLE  
PATTERN**

NOTES:

- ①. MOLDING MATERIAL; GLASS FILLED 30 % MIN POLYESTER. FLAME RETARDANT UL 94-0 COLOR - BLACK.  
THIS PRODUCT WILL WITHSTAND EXPOSURE TO 260°C TEMPERATURE FOR 15 SECONDS IN A WAVE SOLDER APPLICATION WITH A .06 [1.5mm] THICK PCB.
- ②. TERMINAL MATERIAL, .0250±.0015/.635±.038 SQUARE 3/4 HARD PHOSPHOR BRONZE ALLOY UNS C510000. PLATING SEE TABULATION
- ③. .05/1.3 MAX HIGH FLASH
- ④. .03/.8 MAX FLASH.
- ⑤. TWO SIDES OF LEAD-IN ON PINS NOT PLATED. TYPICAL BOTH ENDS.
- ⑥. UL RECOGNIZED PRODUCT.
- ⑦. GXT Pd/Ni PLATED PRODUCT HAS GOLD FLASH.
- ⑧. FCI LOGO AND PART NUMBER ON THIS SURFACE WHEN POSSIBLE.
- ⑨. ADD SUFFIX LF AT THE END OF PART NUMBER FOR LEAD FREE OPTION.
- ⑩. THIS PRODUCT MEETS EUROPEAN UNION DIRECTIVES AND OTHER COUNTRY REGULATIONS AS DESCRIBED IN GS-22-008.
- ⑪. THIS PRODUCT MAY HAVE 100% TIN PLATING IN THE INTERFACE AND HAS NOT BEEN TESTED FOR WHISKER GROWTH IN INTERCONNECT ENVIRONMENTS.

mat'l. code NOTE 1		tolerances unless otherwise specified		CUSTOMER COPY	 www.fciconnect.com		
ltr	ecn no	dr	date	linear	projection	title	
AL				.XX±.01/.X±.3		TOP SHIELDED RIGHT ANGLE HEADER	
				.XXX±.005/.XX±.13			product family HEADERS
				.XXX±.0020/.XXX±.051	INCH/MM	size	
				angles	scale	dwg no	
				0° ±2°	2:1	65461	
				dr	R SEIPLE	3-30-90	sheet 2 of
				enr	H SUNDY	3-30-90	
				chr	H SUNDY	3-30-90	
				appd	H SUNDY	3-30-90	
sheet index	revision sheet						

cage code  
22526

Tous droits strictement reserves. Reproduction ou communication a des tiers interdite sous quelque forme que ce soit sans autorisation ecrite du proprietaire. Propriete de c FCI. Droits de reproduction FCI.

All rights strictly reserved. Reproduction or issue to third parties in any form whatever is not permitted without written authority from the proprietor. Property of FCI. Copyright FCI.



A

B

A

B

Tous droits strictement reserves. Reproduction ou communication a des tiers interdite sous quelque forme que ce soit sans autorisation ecrite du proprietaire. Propriete de c FCI. Droits de reproduction FCI.

All rights strictly reserved. Reproduction or issue to third parties in any form whatever is not permitted without written authority from the proprietor. Property of FCI. Copyright FCI.

PRODUCT NO	NO OF POS	DIM A	DIM B	DIM C	OVERPLATING	UNDERPLATING	STYLE	POSITIONS POLARIZED	LF OPTION
65461-001	2x8	.800/20.32	.700/17.78	.09/2.3	30u"/.76u GOLD	50u"/1.27u NICKEL	P	NONE	↑
↑ -002	2x9	.900/22.86	.800/20.32	↑	↑	↑	P	↑	↑
-003	2x10	1.000/25.40	.900/22.86				M		
-004	2x12	1.200/30.48	1.100/27.94				P		
-005	2x13	1.300/33.02	1.200/30.48				M		
-006	2x17	1.700/43.18	1.600/40.64				↑		
-007	2x20	2.000/50.80	1.900/48.26				↓		
-008	2x25	2.500/63.50	2.400/60.96		30u"/.76u GOLD		M		
-009	2x8	.800/20.32	.700/17.78		150u"/3.81u TIN		P		
-010	2x9	.900/22.86	.800/20.32				↑		
-011	2x10	1.000/25.40	.900/22.86						
-012	2x12	1.200/30.48	1.100/27.94						
-013	2x13	1.300/33.02	1.200/30.48						
-014	2x17	1.700/43.18	1.600/40.64						
-015	2x20	2.000/50.80	1.900/48.26						
-016	2x25	2.500/63.50	2.400/60.96		150u"/3.81u TIN				
-017	2x14	1.400/35.56	1.300/33.02		30u"/.76u GOLD				
-018	2x14	1.400/35.56	1.300/33.02		150u"/3.81u TIN				
-019	2x5	.500/12.70	.400/10.16	↓	30u"/.76u GOLD				
-020	2x5	.500/12.70	.400/10.16	.09/2.3	150u"/3.81u TIN				NOTE 9
-021	2x8	.800/20.32	.700/17.78	.49/12.4	30u"/.76u GOLD			NONE	
-022	2x5	.500/12.70	.400/10.16	.15/3.8	50u"/1.27u GOLD			A-3	
-023	2x5	.500/12.70	.400/10.16	.15/3.8	50u"/1.27u GOLD			A-4	
-024	2x8	.800/20.32	.700/17.78	.15/3.8	50u"/1.27u GOLD			A-3	
-025	2x7	.700/17.78	.600/15.24	.09/2.3	30u"/.76u GOLD			NONE	
-026	2x7	.700/17.78	.600/15.24	.09/2.3	150u"/3.81u TIN			NONE	
-027	2x10	1.000/25.40	.900/22.86	.15/3.8	50u"/1.27u GOLD			A-3	
-028	2x8	.800/20.32	.700/17.78	.15/3.8	50u"/1.27u GOLD		P	A-4,6	
-029	2x10	1.000/25.40	.900/22.86	.09/2.3	30u"/.76u GOLD		M	RDW B	
-030	2x14	1.400/35.56	1.300/33.02	.09/2.3	30u"/.76u GOLD		M	RDW B	
-031	2x20	2.000/50.80	1.900/48.26	.09/2.3	50u"/1.27u GOLD		M	NONE	
-032	2x8	.800/20.32	.700/17.78	.15/3.8	50u"/1.27u GOLD		P	A-2,3,5,&B-2,3	
-033	2x17	1.700/43.18	1.600/40.64	.15/3.8	30u"/.76u GOLD		M	NONE	
-034	2x3	.300/7.62	.200/5.08	.09/2.3			P		
-035	2x6	.600/15.24	.500/12.70	.09/2.3			↑		
-036	2x24	2.400/60.96	2.300/58.42	.09/2.3			↓		
-037	2x20	2.000/50.80	1.900/48.26	.49/12.4			P		
-038	2x5	.500/12.70	.400/10.16	.09/2.3			M		
-039	2x8	.800/20.32	.700/17.78	.15/3.8			↑		
-040	2x13	1.300/33.02	1.200/30.48						
-041	2x10	1.000/25.40	.900/22.86						
↓ -042	2x5	.500/12.70	.400/10.16	↓	↓	↓	↓	↓	↓
65461-001	2x20	2.000/50.80	1.900/48.26	.15/3.8	30u"/.76u GOLD	50u"/1.27u NICKEL	M	NONE	↓

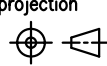
mat'l. code		tolerances unless otherwise specified		CUSTOMER COPY		 www.fciconnect.com	
ltr	ecn no	dr	date	linear	.XX±.01/.X±.3	projection	
AL					.XXX±.005/.XX±.13		
				angles	.XXX±.0020/.XXX±.051	INCH/MM	<b>TOP SHIELDED RIGHT ANGLE HEADER</b>
					0° ±2'		
				dr	R SEIPLE 4-2-90	scale	code
				engr	H SUNDY 4-2-90	1:1	size
				chr	H SUNDY 4-2-90		A
				appd	H SUNDY 4-2-90		65461
sheet index	revision sheet						3 of

Tous droits strictement reserves. Reproduction ou communication a des tiers interdite sous quelque forme que ce soit sans autorisation ecrite du proprietaire. Propriete de c FCI. Droits de reproduction FCI.

**FCI**

All rights strictly reserved. Reproduction or issue to third parties in any form whatever is not permitted without written authority from the proprietor. Property of FCI. Copyright FCI.

PRODUCT NO	NO OF POS	DIM A	DIM B	DIM C	OVERPLATING	UNDERPLATING	STYLE	POSITIONS POLARIZED	LF OPTION
65461-044	2x12	1,200/30.48	1,100/27.94	.26/6.6	30u"/.76u GOLD	50u"/1.27u NICKEL	M	NONE	↑
↑ -045	2x36	3,600/91.44	3,500/88.90	.09/2.3	↕	↑	M	NONE	↑
-046	2x10	1,000/25.40	.900/22.86	.15/3.8			P	A-3	
-047	2x8	.800/20.32	.700/17.78	.15/3.8	30u"/.76u GOLD		P	A-2,3,5 & B-2,3	
-048	2x10	1,000/25.40	.900/22.86	.09/2.3	150u"/3.81u TIN		M	NONE	
-049	2x10	1,000/25.40	.900/22.86	.09/2.3	150u"/.38u GOLD		M	NONE	
-050	2x14	1,400/35.56	1,300/33.02	.18/4.6	30u"/.76u GOLD		P	A-2	
-051	2x17	1,700/43.18	1,600/40.64	.09/2.3	15u"/.38u GOLD		M	NONE	
-052	2x3	.300/7.62	.200/5.08	.09/2.3	30u"/.76u GOLD		M	NONE	
-053	2x5	.500/12.70	.400/10.16	.09/2.3	50u"/1.27u GOLD		P	B-4	
-054	2x13	1,300/33.02	1,200/30.48	.09/2.3	30u"/.76u GXT		M	NONE	
-055	2x12	1,200/30.48	1,100/27.94	.11/2.8	↑		M	NONE	
-056	2x17	1,700/43.18	1,600/40.64	.11/2.8	↑		M	NONE	
-057	2x25	2,500/63.50	2,400/60.96	.11/2.8	↑		M	NONE	
-058	2x13	1,300/33.02	1,200/30.48	.11/2.8	↑		M	NONE	
-059	2x10	1,000/25.40	.900/22.86	.15/3.8	↓		M	ROW B	
-060	2x14	1,400/35.56	1,300/33.02	.15/3.8	↓		M	ROW B	
-061	2x20	2,000/50.80	1,900/48.26	.11/2.8	30u"/.76u GXT		M	NONE	
-062	2x12	1,200/30.48	1,100/27.94	.11/2.8	150u"/3.81u TIN		M	NONE	
-063	2x17	1,700/43.18	1,600/40.64	.11/2.8	↑		M	NONE	NOTE 9
-064	2x25	2,500/63.50	2,400/60.96	.11/2.8	↑		M	NONE	
-065	2x13	1,300/33.02	1,200/30.48	.11/2.8	↑		M	NONE	
-066	2x10	1,000/25.40	.900/22.86	.15/3.8	↓		M	ROW-B	
-067	2x14	1,400/35.56	1,300/33.02	.15/3.8	↓		M	ROW-B	
-068	2x20	2,000/50.80	1,900/48.26	.11/2.8	150u"/3.81u TIN		M	NONE	
-069	2x8	.800/20.32	.700/17.78	.09/2.3	30u"/.76u GOLD		M	NONE	
-070	2x13	1,300/33.02	1,200/30.48	.09/2.3	↑		P	NONE	
-071	2x14	1,400/35.56	1,300/33.02	.11/2.8	↑		M	NONE	
-072	2x32	3,200/81.28	3,100/78.74	.11/2.8	↓		P	NONE	
-073	2x15	1,500/38.106	1,400/35.56	.11/2.8	↓		M	NONE	
↓ -074	2x30	3,000/76.20	2,900/73.66	.11/2.8	30u"/.76u GOLD	↓	M	NONE	↓
65461-075	2x17	1,700/43.18	1,600/40.64	.11/2.8	30u"/.76u GXT	50u"/1.27u NICKEL	P	NONE	↓

mat'l. code				tolerances unless otherwise specified				CUSTOMER COPY		<b>FCI</b> www.fciconnect.com	
ltr	ecn no	dr	date	linear	.XX±.01/.X±.3			projection	title		
AL					.XXX±.005/.XX±.13				TOP SHIELDED RIGHT ANGLE HEADER		
					.XXX±.0020/.XXX±.051				product family HEADERS code 213		
				angles	0° ±2°			INCH/MM	size dwg no		
				dr	R SEIPLE	4-2-90	scale		A 65461 sheet 4 of		
				engr	H SUNDY	4-2-90		1:1			
				chr	H SUNDY	4-2-90					
				appd	H SUNDY	4-2-90					
sheet index	revision sheet										