



Chipsmall Limited consists of a professional team with an average of over 10 year of expertise in the distribution of electronic components. Based in Hongkong, we have already established firm and mutual-benefit business relationships with customers from,Europe,America and south Asia,supplying obsolete and hard-to-find components to meet their specific needs.

With the principle of “Quality Parts,Customers Priority,Honest Operation,and Considerate Service”,our business mainly focus on the distribution of electronic components. Line cards we deal with include Microchip,ALPS,ROHM,Xilinx,Pulse,ON,Everlight and Freescale. Main products comprise IC,Modules,Potentiometer,IC Socket,Relay,Connector.Our parts cover such applications as commercial,industrial, and automotives areas.

We are looking forward to setting up business relationship with you and hope to provide you with the best service and solution. Let us make a better world for our industry!



## Contact us

Tel: +86-755-8981 8866 Fax: +86-755-8427 6832

Email & Skype: info@chipsmall.com Web: www.chipsmall.com

Address: A1208, Overseas Decoration Building, #122 Zhenhua RD., Futian, Shenzhen, China



LOC		DIST		REVISIONS			
P	LTN	DESCRIPTION	DATE	DMN	APVD		
P4		REV PER ECR-13-015977	14OCT2013	CZ	SZ		
P5		REV PER ECR-13-004893	25NOV2013	ML	SZ		
P6		ADD NEW PART 5-6600333-2	11OCT2014	AY	SZ		
P7		REV PER ECR-15-007162	04MAY2015	CZ	SZ		

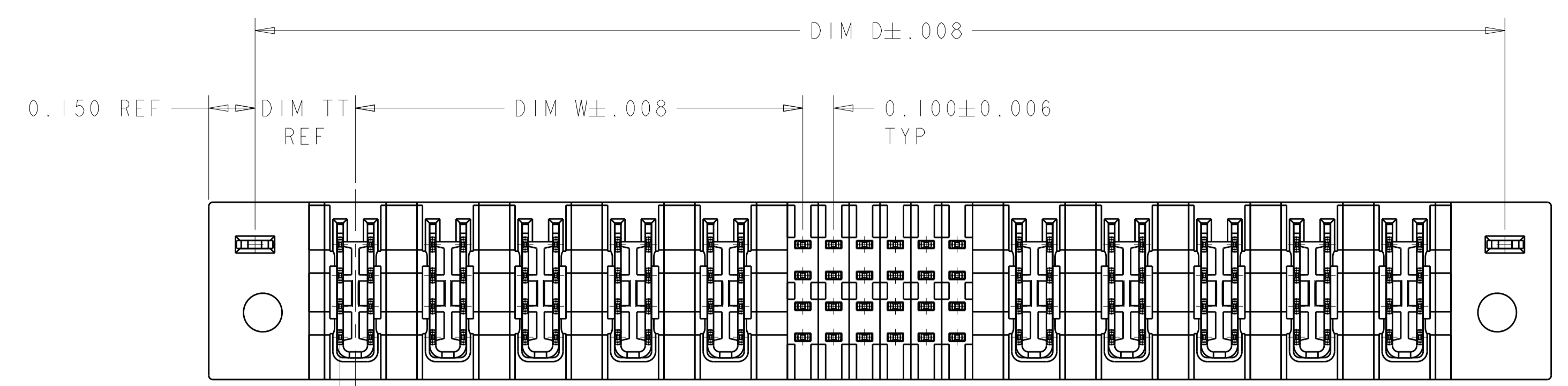

0.050 REF TYP

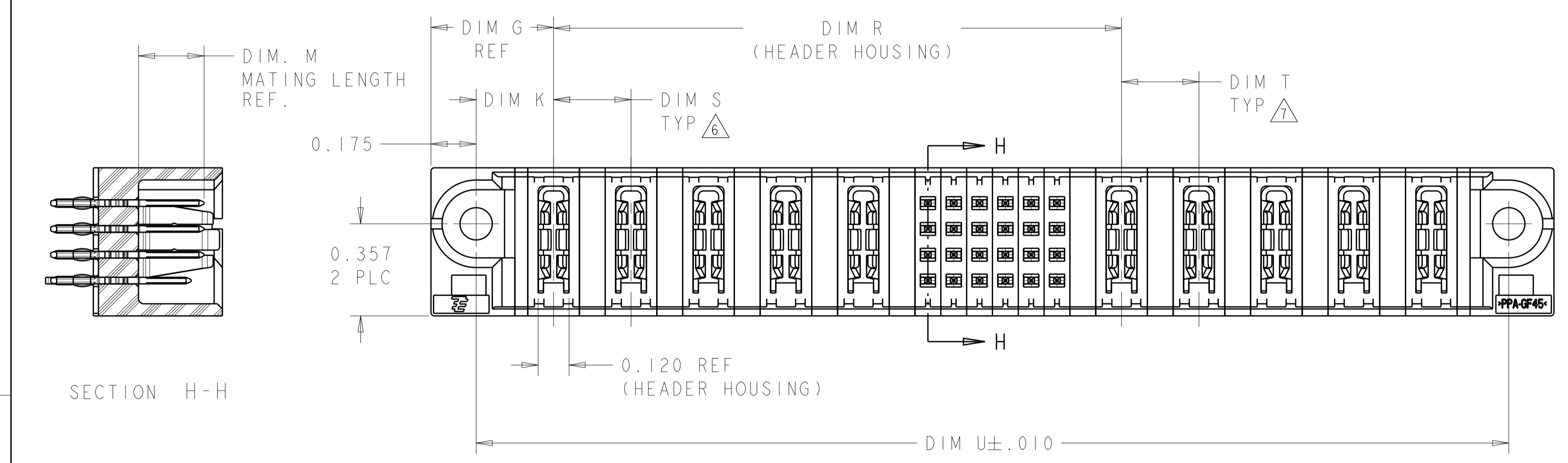
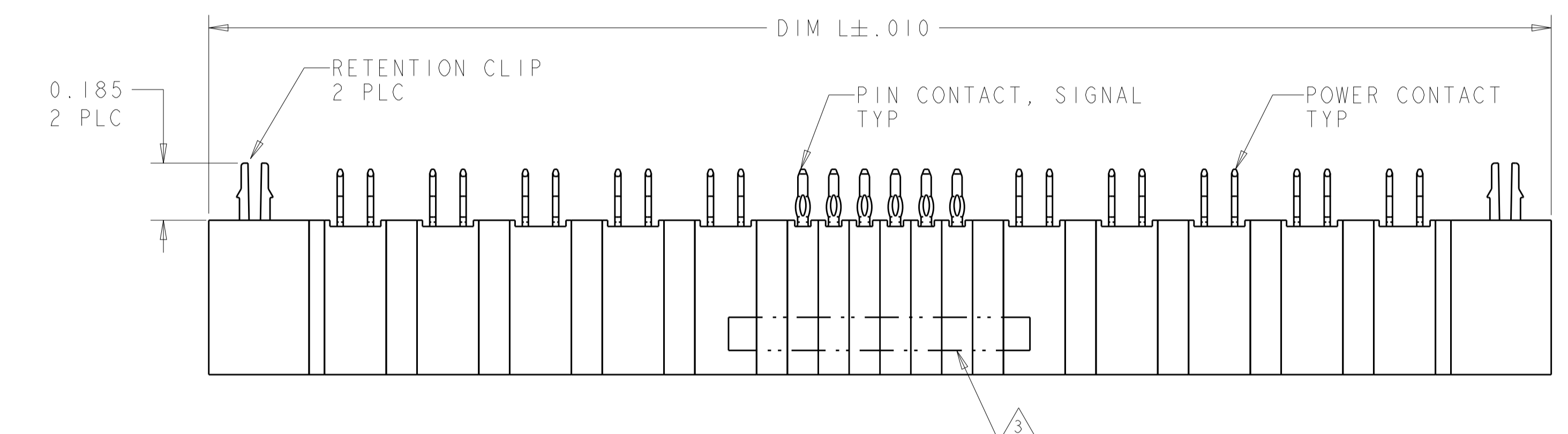

SECTION H-H

- 1. HEADER HOUSING: THERMO PLASTIC, BLACK, UL94 V-0; CONTACTS AND RETENTION CLIPS: COPPER ALLOY.
- 2. CONTACT PLATING: NOBLE METAL PLATING ON CONTACT FUNCTIONAL AREA OF POWER AND SIGNAL CONTACTS
- 3. "AMP", PART NUMBER AND DATE CODE MARKED IN THIS AREA. PARTS UNDER 2.50 LONG MAY BE MARKED ON BOTH SIDES.
- 4. DATUM AND BASIC DIMENSIONS ESTABLISHED BY CUSTOMER.
- 5. PCB - ALL HOLE DIAMETERS ARE FINISHED HOLE SIZES.
- 6. APPLIES TO POWER MODULES ON LEFT SIDE OF SIGNAL CAVITIES OF HOUSING.
- 7. APPLIES TO POWER MODULES ON RIGHT SIDE OF SIGNAL CAVITIES OF HOUSING.
- 8. A SEATING TOOL IS REQUIRED TO SEAT THE HEADER ON THE P.C. BOARD. PLEASE REFER TO THE 114-13038 APPLICATION SPEC.
- 9. MECHANICAL CONNECTOR KEEP OUT ZONE.
- 10. VARIABLE DIMENSION SHOWN VIEW. (SEE SHEET 6)

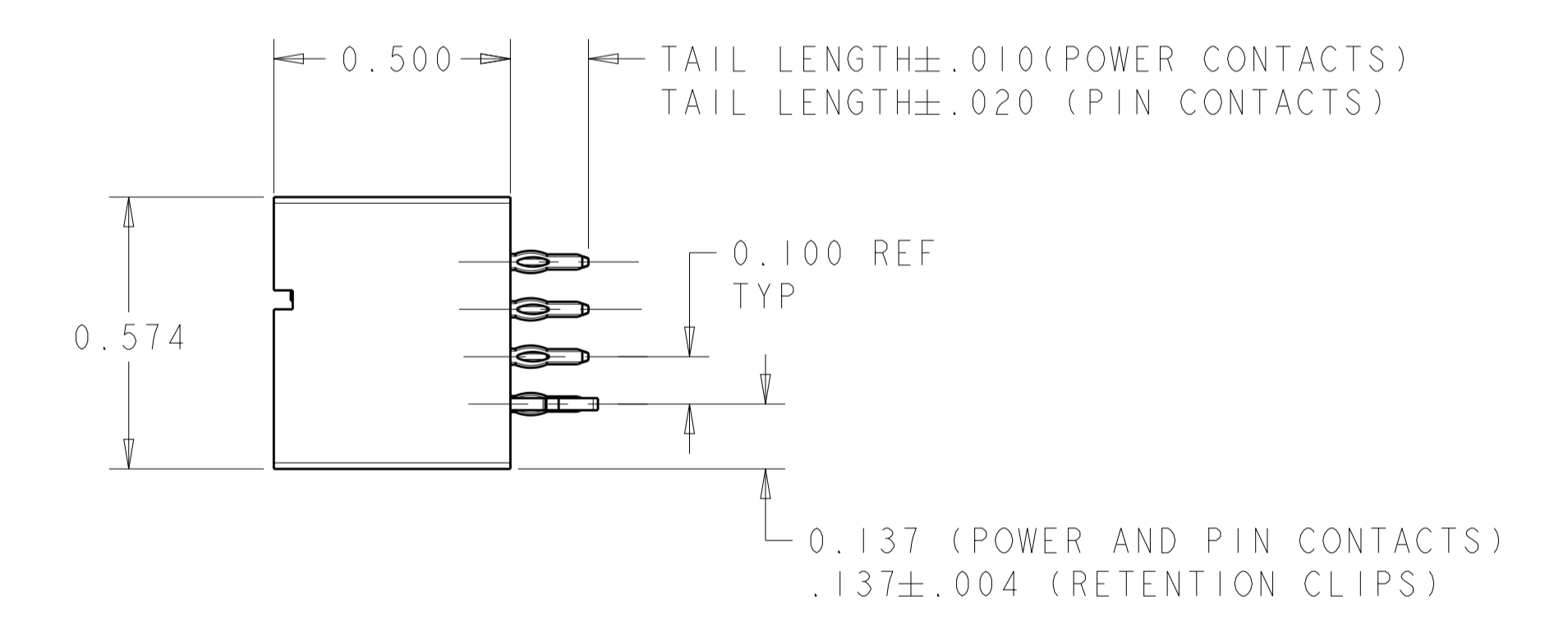

THIS DRAWING IS A CONTROLLED DOCUMENT.		DMN J. McCLINTON 23MAR2005	TE Connectivity
DIMENSIONS: INCH		CHK D. TROUT 23MAR2005	
TOLERANCES UNLESS OTHERWISE SPECIFIED:		APVD B. MLYNE 23MAR2005	NAME VERTICAL HEADER ASSEMBLY, W/GUIDES, PRESS FIT, TYPE PSP MULTI-BEAM XL
0 PLC ±. 1 PLC ±.01 2 PLC ±.01 3 PLC ±.005 4 PLC ±.0020 ANGLES ±.7°		PRODUCT SPEC 108-1973	SIZE A1
MATERIAL FINISH		APPLICATION SPEC 114-13038	CAGE CODE 6600333
		WEIGHT	RESTRICTED TO
		Customer Drawing	SCALE 3:1 SHEET 1 OF 22 REV P7

LOC		DIST		REVISIONS			
ES	00	P	LTN	DESCRIPTION	DATE	OWN	APVD
		-	-	SEE SHEET 1	-	-	-

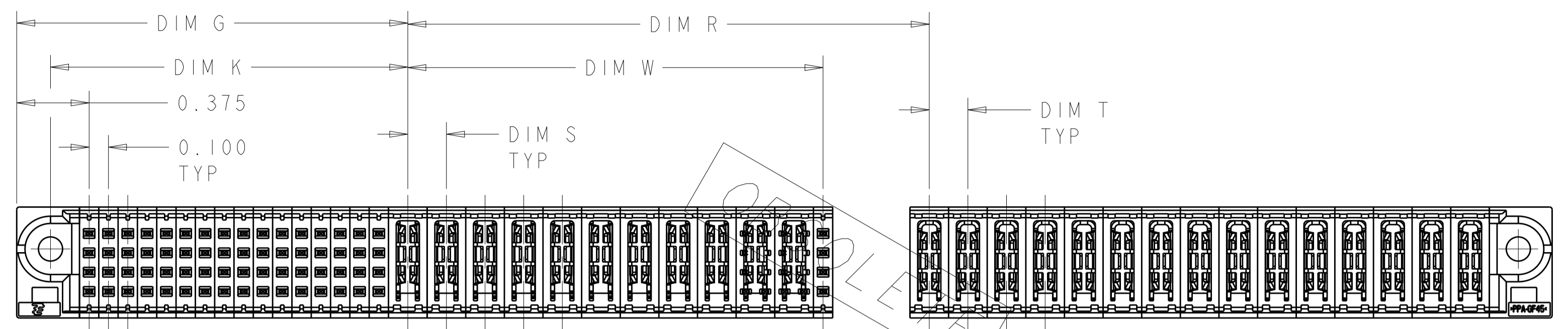

PART NUMBER 2-6600333-3  
 UNSPECIFIED REFER TO TEH SHEET 1

DIM "TT"	DIM "W"	DIM "U"	DIM "T"	DIM "S"	DIM "R"	DIM "L"	DIM "K"	DIM "G"	DIM "D"	RETENTION CLIP	DESCRIPTION	PART NO	
P6	.300	.425	2.500	.250	.250	1.700	2.850	.275	.450	2.550	NO	2P + 48S + 2P	5-6600333-2
	.300	1.425	4.250	.250	.250	2.700	4.600	.275	.450	4.300	NO	6P + 48S + 5P	5-6600333-1
P1	.300	.425	2.400	.250	.250	1.100	2.750	.275	.450	2.450	NO	2P + 24S + 4P	5-6600333-0
	.300	.175	1.100	-	-	.550	1.450	.275	.450	1.150	YES	1P + 12S + 1P	4-6600333-9
N7	.300	1.225	4.000	.250	.250	2.200	4.350	.275	.450	4.057	NO	5P + 24S + 6P	4-6600333-8
N3	.300	.925	2.600	.250	.250	1.300	2.950	.275	.450	2.650	YES	4P + 12S + 4P	4-6600333-6
N5	.325	.550	2.200	.300	.300	1.300	2.550	.300	.475	2.250	YES	2ACP + 24S + 2ACP	4-6600333-5
	.300	.425	1.900	.250	.250	1.100	2.250	.275	.450	1.950	YES	2P + 24S + 2P	4-6600333-4
N4	.325	.550	2.200	.300	.300	1.300	2.550	.300	.475	2.250	YES	2ACP + 24S + 2ACP	4-6600333-3
	.300	1.925	4.700	.250	.250	2.400	5.050	.275	.450	4.750	YES	8P + 16S + 8P	4-6600333-2
	.300	.425	1.600	.250	.250	.800	1.950	.275	.450	1.650	YES	2P + 12S + 2P	4-6600333-1
	.325	.850	2.800	.300	.300	1.600	3.150	.300	.475	2.850	YES	3ACP + 24S + 3ACP	3-6600333-9
	.300	1.425	3.500	.250	.250	1.700	3.850	.275	.450	3.550	YES	6P + 8S + 6P	3-6600333-8
	.300	.475	2.000	.250	.250	1.200	2.350	.275	.450	2.050	YES	2P + 24S + 2P	3-6600333-7
	.300	.925	3.700	.250	.250	2.400	4.050	.275	.450	3.750	NO	4P + 56S + 4P	3-6600333-6
	.300	.675	2.400	.250	.250	1.350	2.750	.275	.450	2.450	YES	3P + 24S + 3P	3-6600333-5
	.300	.925	2.500	.250	.250	1.200	2.850	.275	.450	2.550	YES	4P + 8S + 4P	3-6600333-4
	.300	.925	2.700	.250	.250	1.400	3.050	.275	.450	2.750	NO	4P + 16S + 4P	3-6600333-3
	.300	.925	2.900	.250	.250	1.600	3.250	.275	.450	2.950	NO	4P + 24S + 4P	3-6600333-2
	.325	1.750	4.800	.250	.300	2.475	5.150	.300	.475	4.850	YES	6ACP + 24S + 8P	3-6600333-1
	.300	.225	1.300	-	-	.750	1.650	.275	.450	1.350	YES	1P + 16S + 1P	3-6600333-0
	.300	.425	2.100	-	.250	1.300	2.450	.275	.450	2.150	YES	2P + 32S + 2P	2-6600333-9
	.300	.925	2.450	.250	.250	1.400	2.800	.275	.450	2.500	YES	4P + 16S + 3P	2-6600333-8
	.300	.975	3.250	.250	.250	1.700	3.600	.275	.450	3.300	YES	4P + 24S + 5P	2-6600333-7
	.300	.675	2.400	.250	.250	1.350	2.750	.275	.450	2.450	YES	3P + 24S + 3P	2-6600333-6
	.300	.925	2.450	.250	.250	1.400	2.800	.275	.450	2.500	YES	4P + 16S + 3P	2-6600333-5
	.275	2.000	5.450	△	△	2.650	5.800	.250	.425	5.500	YES	10P + 24S + 12P	2-6600333-4
	1.875	2.150	7.600	△	△	2.700	7.950	1.850	2.025	7.650	YES	64S+11P+20S+15P	2-6600333-3
	.275	2.000	5.450	△	△	2.650	5.800	.250	.425	5.500	YES	10P + 24S + 12P	2-6600333-2
	.325	1.750	4.800	.250	.300	2.475	5.150	.300	.475	4.850	YES	6ACP + 24S + 8P	2-6600333-1
	.300	.475	2.000	.250	.250	1.200	2.350	.275	.450	2.050	YES	2P + 24S + 2P	1-6600333-6
	.300	1.425	3.900	.250	.250	2.100	4.250	.275	.450	3.950	YES	6P + 24S + 6P	1-6600333-5
	.300	.975	3.200	.250	.250	1.900	3.550	.275	.450	3.250	YES	4P + 32S + 4P	1-6600333-4
	.300	1.425	3.900	.250	.250	2.100	4.250	.275	.450	3.950	YES	6P + 24S + 6P	1-6600333-3
	.300	.425	1.900	.250	.250	1.100	2.250	.275	.450	1.950	YES	2P + 24S + 2P	1-6600333-2
	.325	.850	2.800	.300	.300	1.600	3.150	.300	.475	2.850	YES	3ACP + 24S + 3ACP	1-6600333-1
	.300	.475	1.800	.250	.250	1.000	2.150	.275	.450	1.850	YES	2P + 16S + 2P	1-6600333-0
	.300	.225	1.300	-	-	.750	1.650	.275	.450	1.350	YES	1P + 16S + 1P	6600333-9
	.300	.425	3.250	-	.250	2.700	3.600	.275	.450	3.300	YES	2P + 88S + 1P	6600333-8
	.300	.725	2.300	.250	.250	1.250	2.650	.275	.450	2.350	YES	3P + 16S + 3P	6600333-7
	.300	.975	3.000	.250	.250	1.700	3.350	.275	.450	3.050	YES	4P + 24S + 4P	6600333-6
	.300	.475	2.000	.250	.250	1.200	2.350	.275	.450	2.050	YES	2P + 24S + 2P	6600333-5
	.300	.425	1.700	.250	.250	.900	2.050	.275	.450	1.750	YES	2P + 16S + 2P	6600333-4
	.325	1.450	4.000	.300	.300	2.200	4.350	.300	.475	4.050	YES	5ACP + 24S + 5ACP	6600333-1

OBSOLETE

THIS DRAWING IS A CONTROLLED DOCUMENT.

DIMENSIONS: INCH	TOLERANCES UNLESS OTHERWISE SPECIFIED: 0 PLC ±. 1 PLC ±.01 2 PLC ±.01 3 PLC ±.005 4 PLC ±.002 ANGLES ±.020	OWN J. McCLINTON 23MAR2005 CHK D. TROUT 23MAR2005 APVD B. WILBYNE 23MAR2005	NAME VERTICAL HEADER ASSEMBLY, W/GUIDES, PRESS FIT, TYPE PSP MULTI-BEAM XL SIZE CAGE CODE DRAWING NO RESTRICTED TO A100779C=6600333
---------------------	--	---	---

MATERIAL FINISH WEIGHT

Customer Drawing SCALE 3:1 SHEET 2 OF 22 REV P7

PART NUMBER	ROWS	POWER					SIGNAL						POWER				
		P1	P2	P3	P4	P5	1	2	3	4	5	6	P6	P7	P8	P9	P10
6600333-1	D	VM	VM	VM	VM	VM	EV	EV	EV	EV	EV	EV	VM	VM	VM	VM	VM
	C						EV	EV	EV	EV	EV	EV					
	B						EV	EV	EV	EV	EV	EV					
	A						ES	ES	ES	ES	ES	ES					
5ACP+24S+5ACP		HD															

PART NUMBER	ROWS	POWER		SIGNAL						POWER		
		P1	P2	1	2	3	4	5	6	P3	P4	
6600333-5	D	VM	VM	EV	EV	EV	EV	EV	EV	EV	VM	VM
	C			EV	EV	EV	EV	EV	EV			
	B			EV	EV	EV	EV	EV	EV			
	A			ES	ES	ES	ES	ES	ES			
2P+24S+2P		HD										

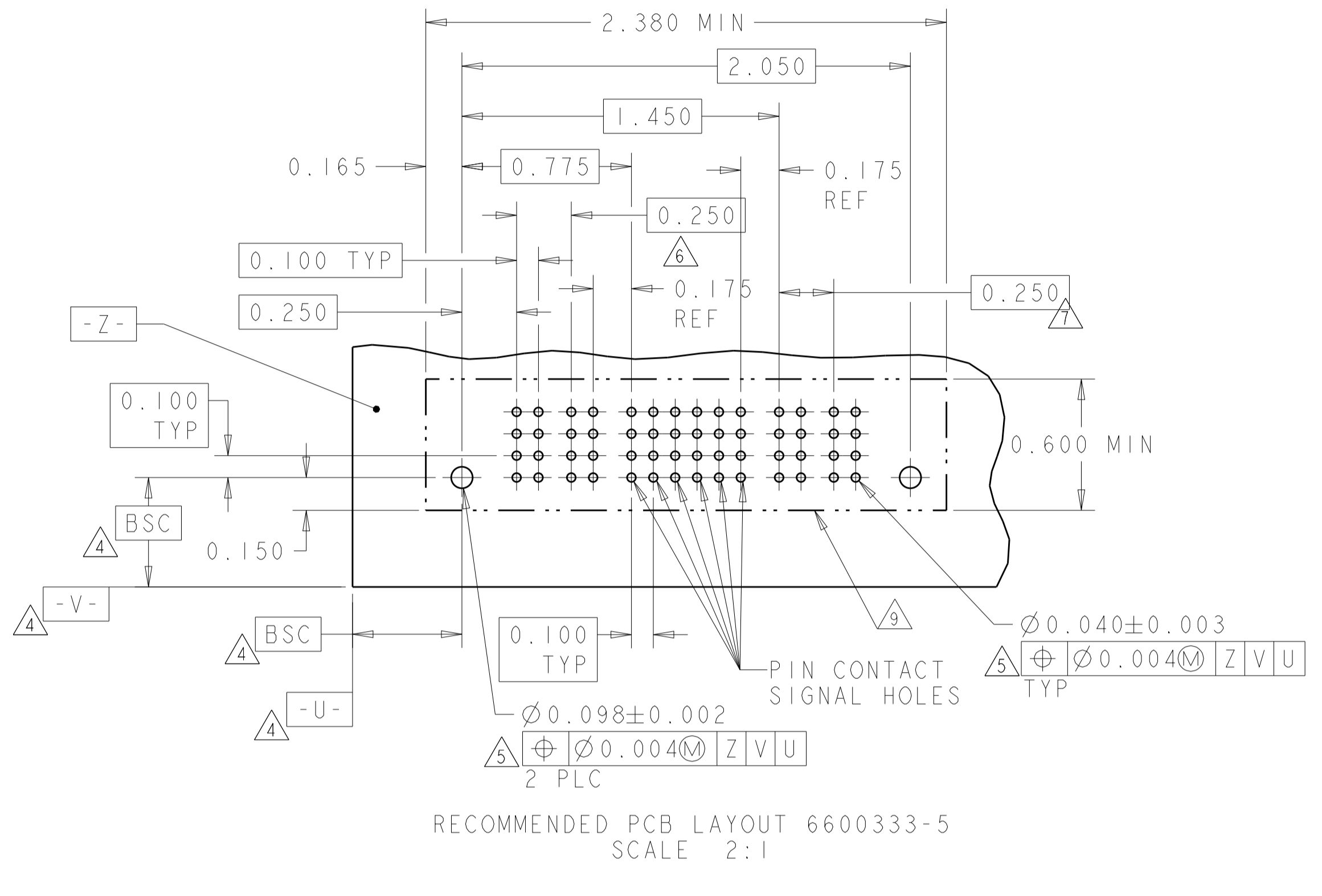
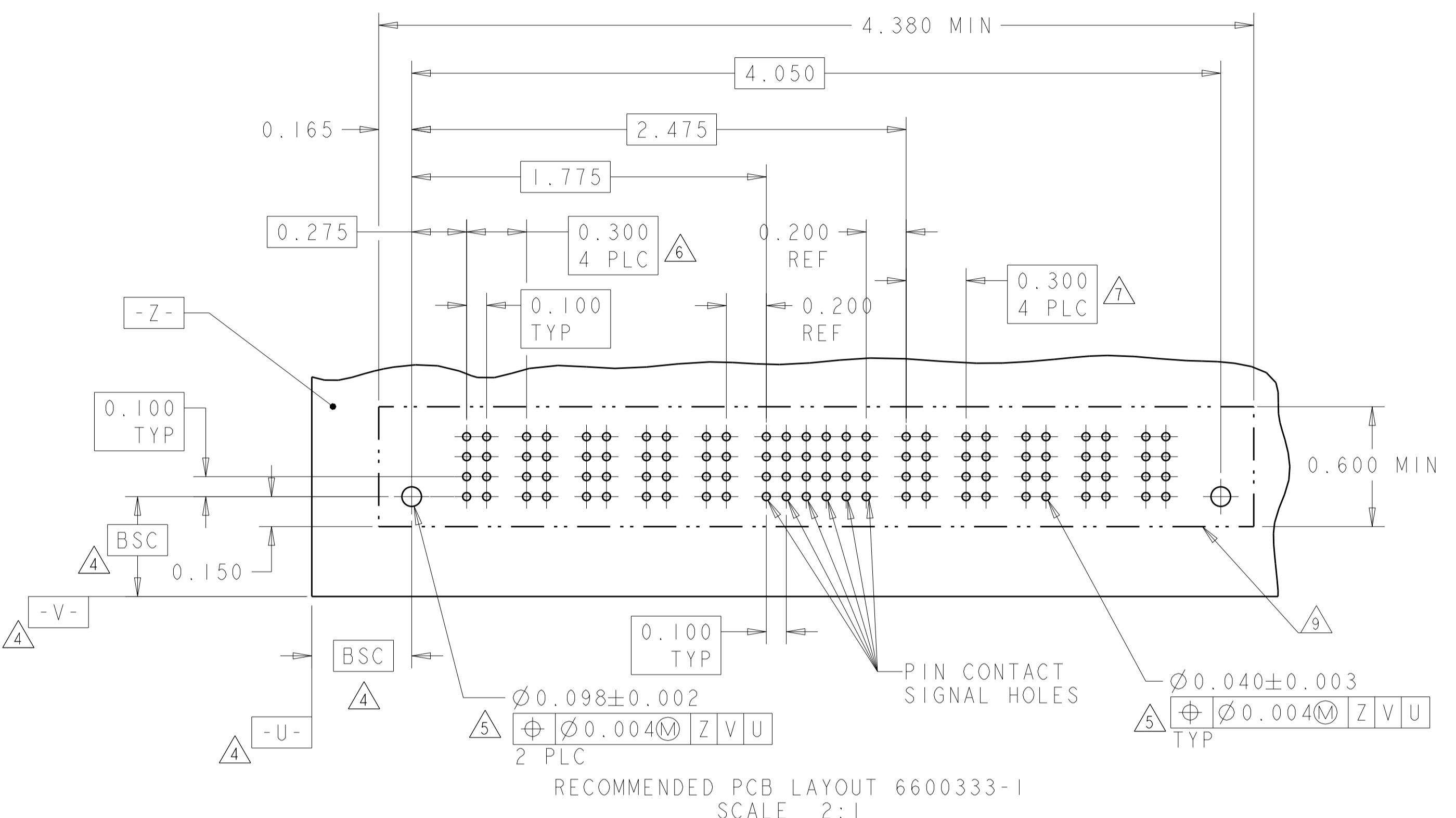

PART NUMBER	ROWS	POWER		SIGNAL				POWER	
		P1	P2	1	2	3	4	P3	P4
6600333-4	D	VM	VM	EV	EV	EV	EV	VM	VM
	C			EV	EV	EV	EV		
	B			EV	EV	EV	EV		
	A			EV	EV	EV	EV		
2P+16S+2P		HD							

PART NUMBER	ROWS	POWER				SIGNAL						POWER			
		P1	P2	P3	P4	1	2	3	4	5	6	P5	P6	P7	P8
6600333-6	D	VM	VM	VM	VM	ES	ES	ES	ES	EV	ES	VM	VM	VM	VM
	C					ES	ES	ES	ES	EV	ES				
	B					ES	ES	ES	ES	EV	ES				
	A					ES	ES	EV	ES	EV	ES				
4P+24S+4P		HD													

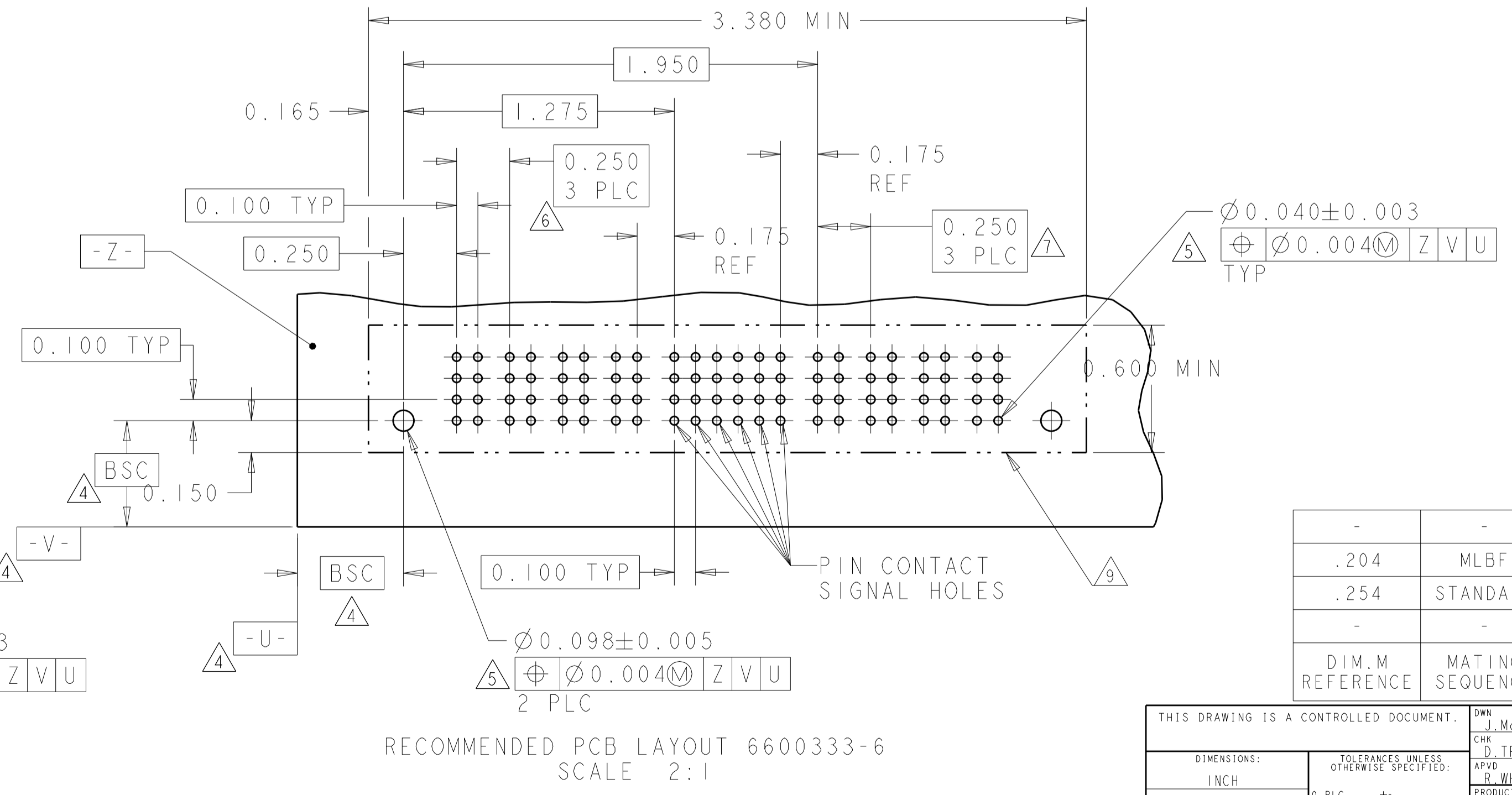
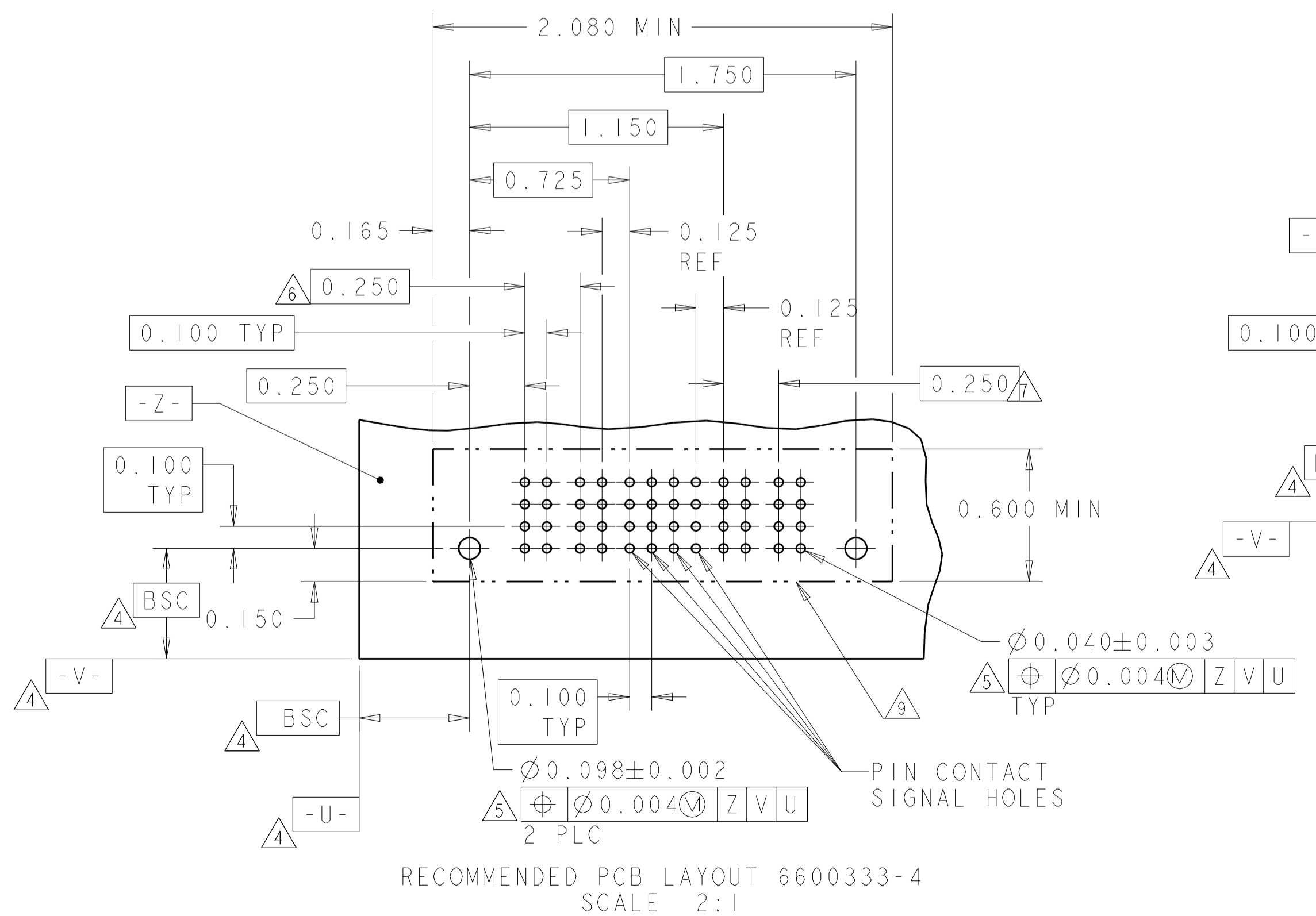

DIM. M REFERENCE	MATING SEQUENCE	DESCRIPTION	IDENTIFIER
-	-	RETENTION CLIP	HD
.204	MLBF	SIGNAL CONTACT .165 TAIL LENGTH	ES
.254	STANDARD	SIGNAL CONTACT .165 TAIL LENGTH	EV
-	-	POWER CONTACT .165 TAIL LENGTH	VM

THIS DRAWING IS A CONTROLLED DOCUMENT.

DIMENSIONS:	TOLERANCES UNLESS OTHERWISE SPECIFIED:	OWN: J. McCLINTON 23MAR2005	CHK: D. TROUT 23MAR2005
INCH	0 PLC ±.01 1 PLC ±.01 2 PLC ±.01 3 PLC ±.005 4 PLC ±.002	APVD: B. MLYNE 23MAR2005	PRODUCT SPEC
MATERIAL:	FINISH:	108-1973	APPLICATION SPEC
		114-13038	WEIGHT
			Customer Drawing

SCALE 3:1 SHEET 3 OF 22 REV P7

TE Connectivity  
 VERTICAL HEADER ASSEMBLY, W/GUIDES, PRESS FIT, TYPE PSP MULTI-BEAM XL

SIZE: A100779 CAGE CODE: 6600333

PART NUMBER	ROWS	POWER			SIGNAL				POWER		
		P1	P2	P3	1	2	3	4	P4	P5	P6
6600333-7	D	VM	VM	VM	EV	EV	EV	EV	VM	VM	VM
	C				ES	ES	ES	ES			
	B				ES	ES	ES	ES			
	A				EV	EV	EV	EV			
3P+16S+3P		HD									HD

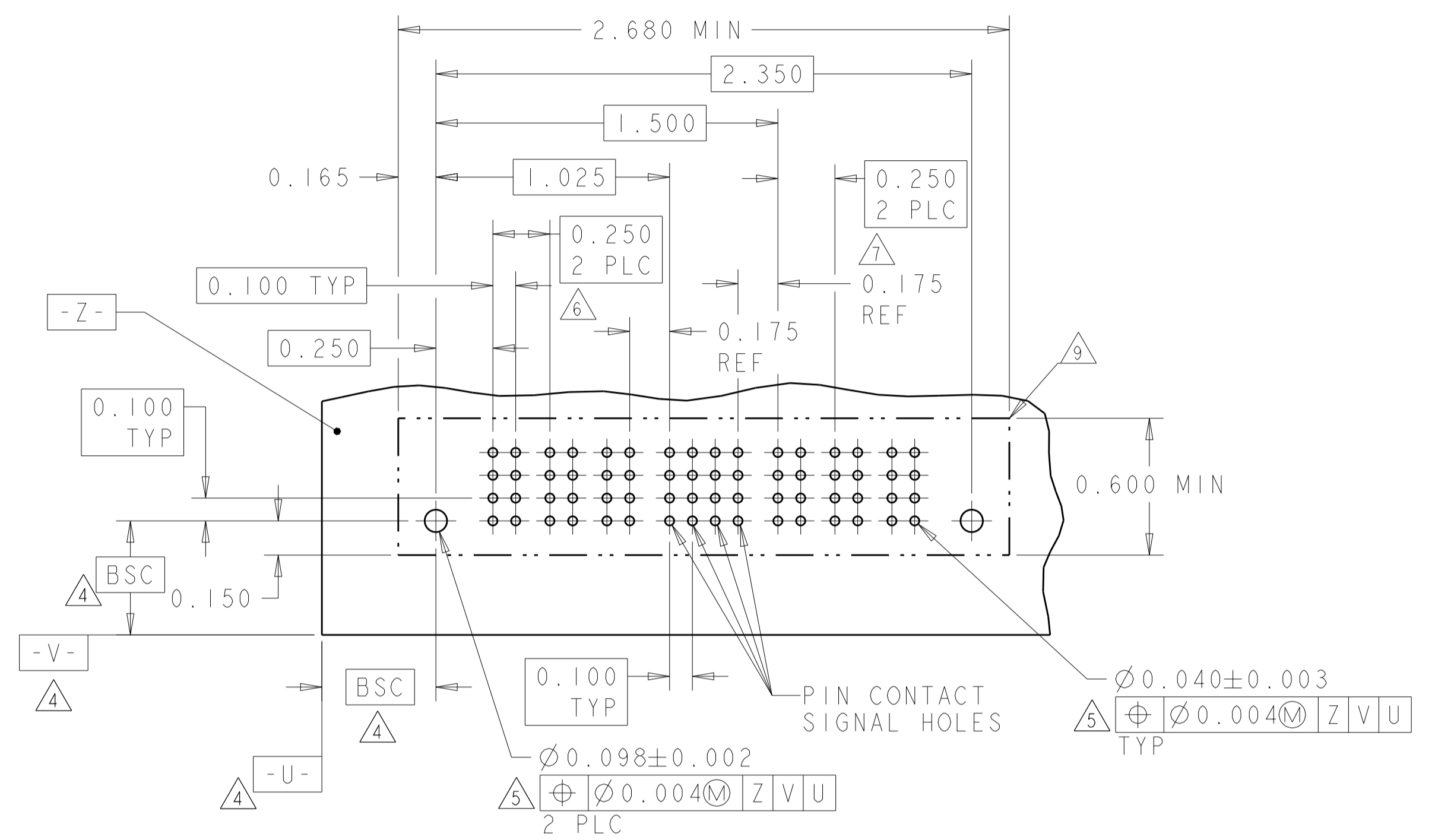

RECOMMENDED PCB LAYOUT 6600333-7  
 SCALE 2:1

PART NUMBER	ROWS	POWER		SIGNAL																		POWER						
		P1	P2	1	2	3	4	5	6	7	8	9	10	11	12	13	14	15	16	17	18	19	20	21	22	P3		
6600333-8	D	VM	VM	EV	EV	EV	EV	EV	EV	EV	EV	EV	EV	EV	EV	EV	EV	EV	EV	EV	EV	EV	EV	EV	EV	EV	VM	
	C			EV	EV	EV	EV	EV	EV	EV	EV	EV	EV	EV	EV	EV	EV	EV	EV	EV	EV	EV	EV	EV	EV	EV		
	B			EV	EV	EV	EV	EV	EV	EV	EV	EV	EV	EV	EV	EV	EV	EV	EV	EV	EV	EV	EV	EV	EV	EV		EV
	A			EV	EV	EV	EV	EV	EV	EV	EV	EV	EV	EV	EV	EV	EV	EV	EV	EV	EV	EV	EV	EV	EV	EV		EV
2P+88S+1P		HD																									HD	

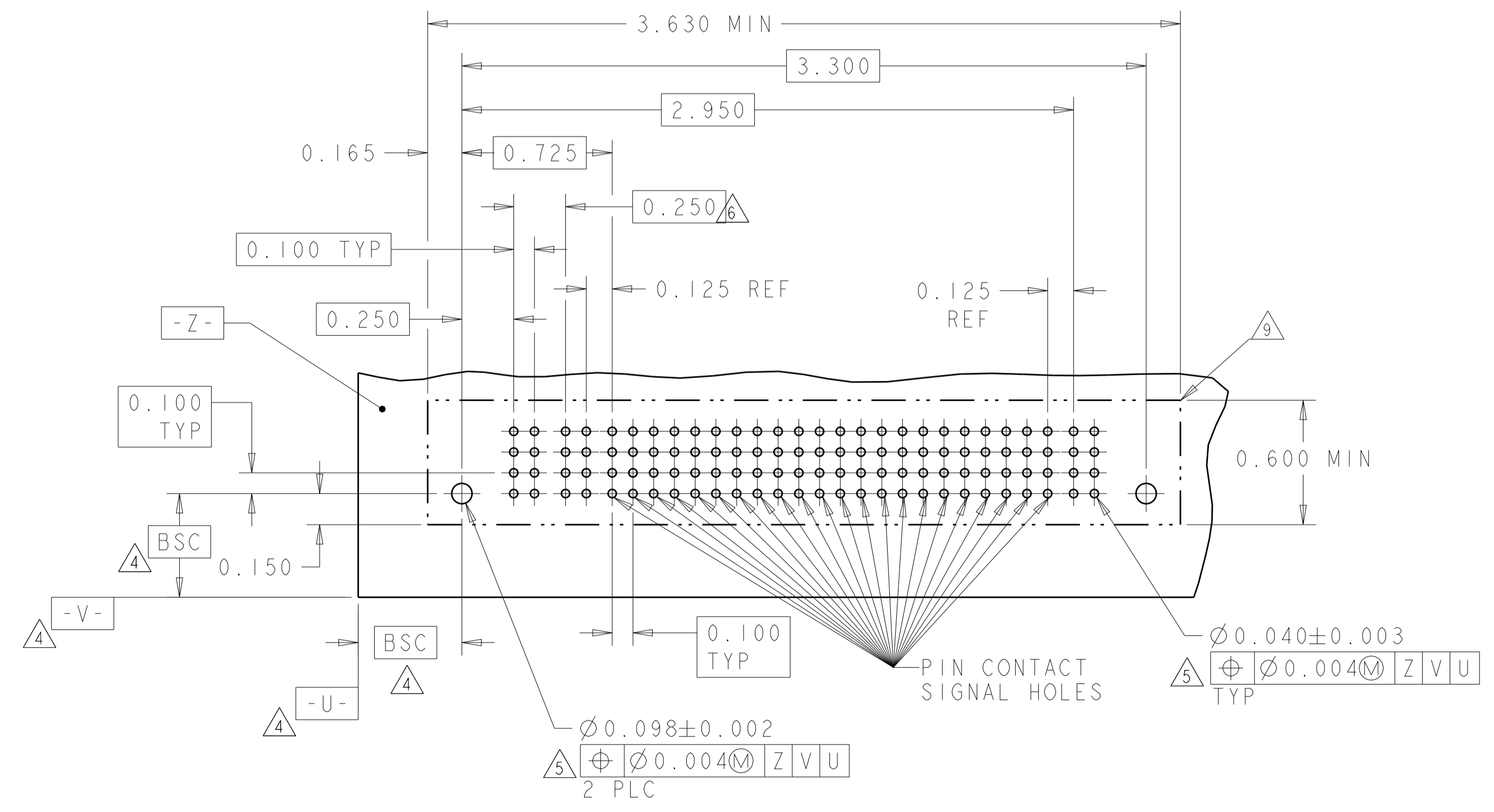

RECOMMENDED PCB LAYOUT 6600333-8  
 SCALE 2:1

LOC	DIST	REVISIONS			
P	LTN	DESCRIPTION	DATE	DMN	APVD
ES	00	SEE SHEET 1			

PART NUMBER	ROWS	POWER		SIGNAL				POWER
		P1	P2	1	2	3	4	P2
6600333-9	D	VM	VM	ES	EV	ES	EV	VM
	C			EV	EV	EV	EV	
	B			ES	EV	ES	EV	
	A			ES	EV	ES	EV	
IP+16S+IP		HD						HD

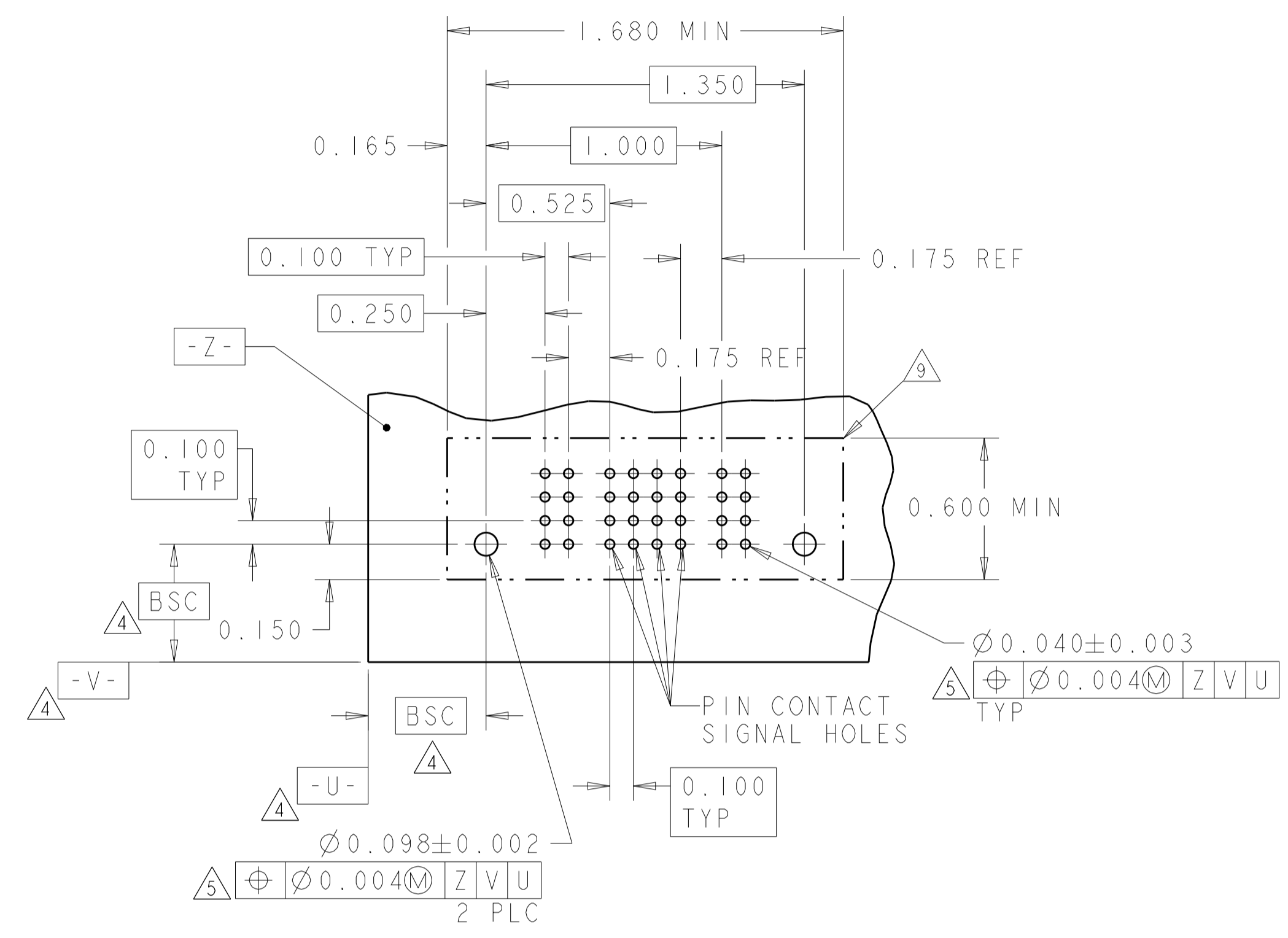

RECOMMENDED PCB LAYOUT 6600333-9  
 SCALE 2:1

PART NUMBER	ROWS	POWER		SIGNAL				POWER
		P1	P2	1	2	3	4	P2
3-6600333-0	D	VM	VM	ES	EV	EV	ES	VM
	C			EV	EV	EV	EV	
	B			EV	EV	EV	EV	
	A			EV	EV	EV	EV	
IP+16S+IP		HD						HD

THE PCB LAYOUT OF 3-6600333-0 IS SAME AS 6600333-9

THIS DRAWING IS A CONTROLLED DOCUMENT.

DIMENSIONS:	TOLERANCES UNLESS OTHERWISE SPECIFIED:	DMN	J. McCLINTON	23MAR2005
INCH	0 PLC ±.01 1 PLC ±.01 2 PLC ±.01 3 PLC ±.005 4 PLC ±.002	CHK	D. TROUT	23MAR2005
MATERIAL:	FINISH:	APVD	B. MLYNE	23MAR2005
		PRODUCT SPEC	NAME	
		APPLICATION SPEC	VERTICAL HEADER ASSEMBLY, W/GUIDES, PRESS FIT, TYPE PSP MULTI-BEAM XL	
		SIZE	CAGE CODE	DRAWING NO
		114-13038	A100779	6600333
		WEIGHT	RESTRICTED TO	
			Customer Drawing	
		SCALE	3:1	SHEET 4 OF 22
				REV P7

4805 (3/11)

PART NUMBER	ROWS	POWER		SIGNAL				POWER	
		P1	P2	1	2	3	4	P3	P4
I-6600333-0	D	VM	VM	EV	EV	EV	EV	VM	VM
	C			ES	ES	ES	ES		
	B			ES	ES	ES	ES		
	A			EV	EV	EV	EV		
2P+16S+2P		HD						HD	

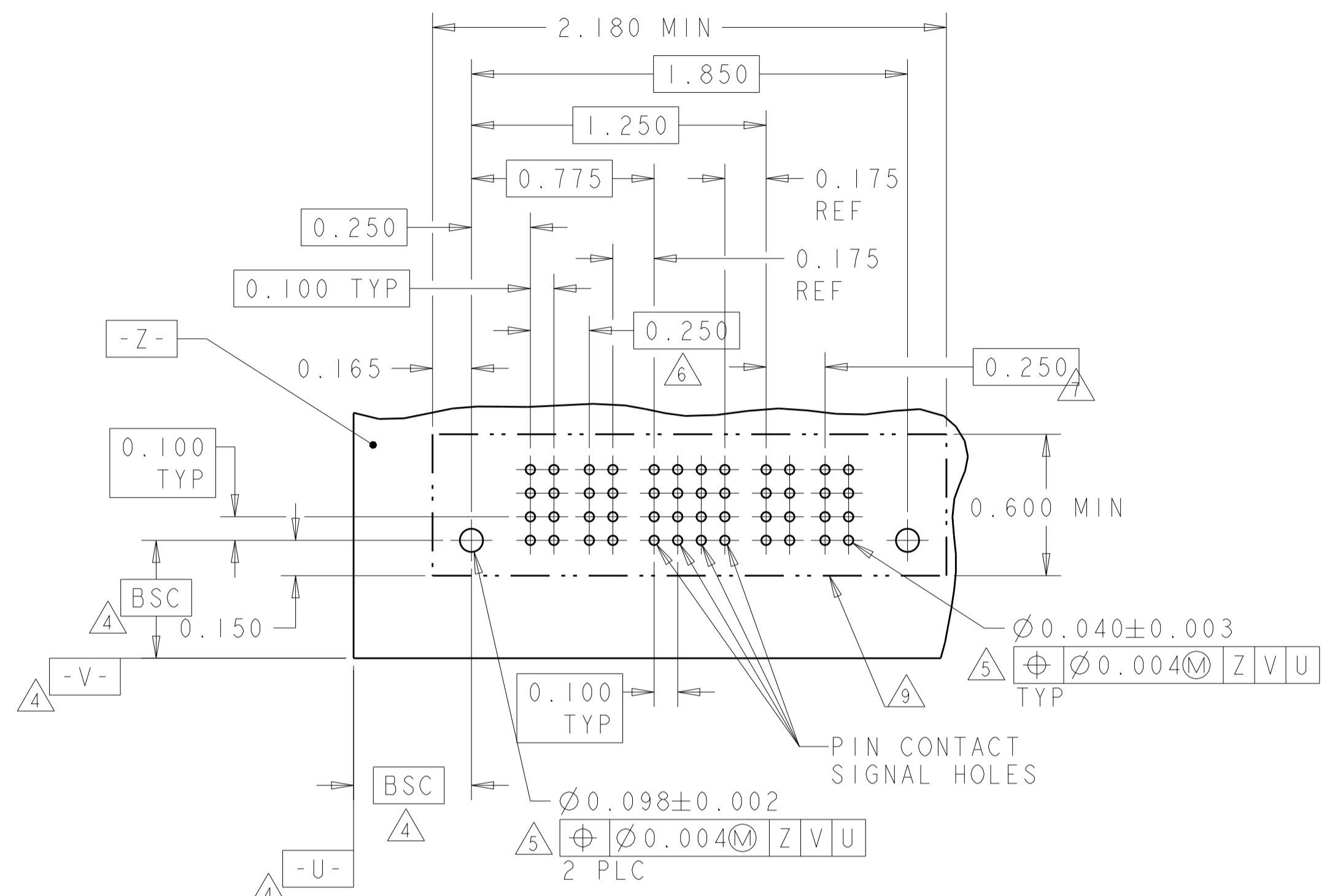

RECOMMENDED PCB LAYOUT I-6600333-0  
 SCALE 2:1

PART NUMBER	ROWS	POWER			SIGNAL						POWER		
		P1	P2	P3	1	2	3	4	5	6	P4	P5	P6
I-6600333-1	D	VM	VM	VM	EV	EV	EV	EV	EV	EV	VM	VM	VM
	C				EV	EV	EV	EV	EV				
	B				EV	EV	EV	EV	EV				
	A				EV	EV	EV	EV	EV				
3ACP+24S+3ACP		HD								HD			

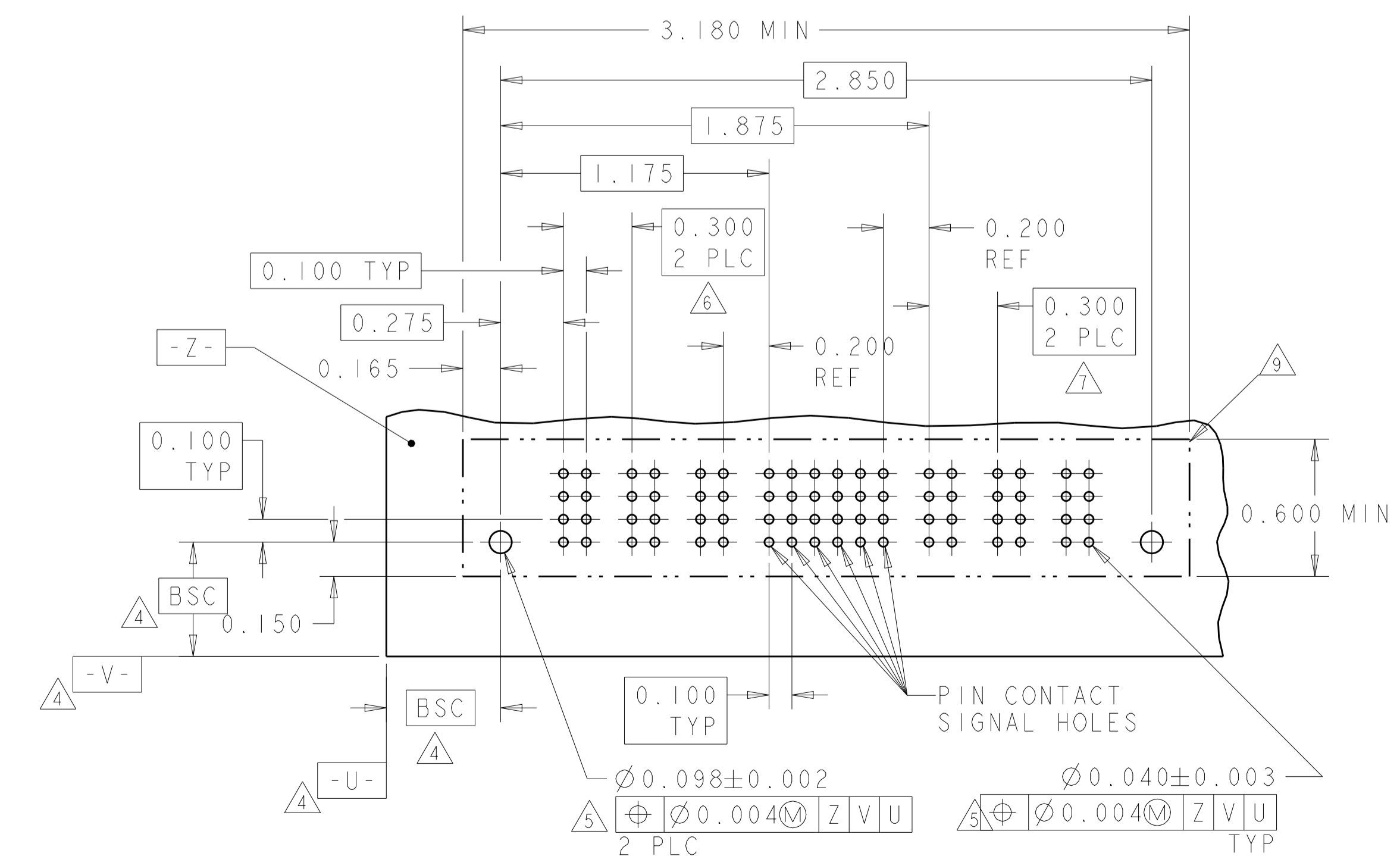

RECOMMENDED PCB LAYOUT I-6600333-1  
 SCALE 2:1

PART NUMBER	ROWS	POWER		SIGNAL						POWER	
		P1	P2	1	2	3	4	5	6	P3	P4
I-6600333-2	D	VM	VM	EV	EV	EV	EV	EV	EV	VM	VM
	C			EV	EV	EV	EV	EV			
	B			EV	EV	EV	EV	EV			
	A			EV	EV	EV	EV	EV			
2P+24S+2P		HD								HD	

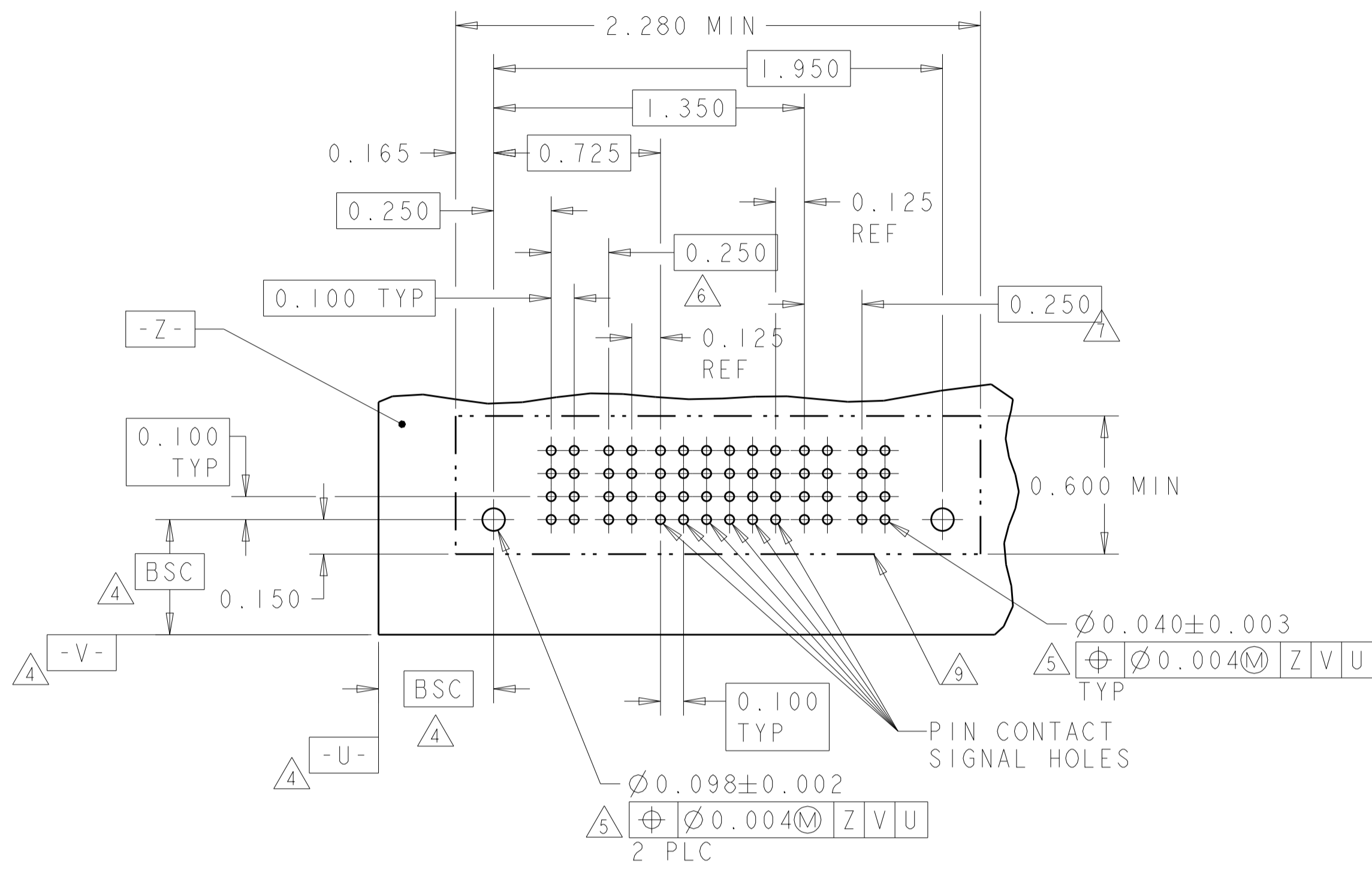

RECOMMENDED PCB LAYOUT I-6600333-2  
 SCALE 2:1

PART NUMBER	ROWS	POWER						SIGNAL						POWER							
		P1	P2	P3	P4	P5	P6	1	2	3	4	5	6	P7	P8	P9	P10	P11	P12		
I-6600333-3	D	VM	VM	VM	VM	VM	VM	EV	EV	EV	EV	EV	EV	VM	VM	VM	VM	VM	VM		
	C							EV	EV	EV	EV	EV									
	B							EV	EV	EV	EV	EV									
	A							EV	EV	EV	EV	EV									
6P+24S+6P		HD														HD					

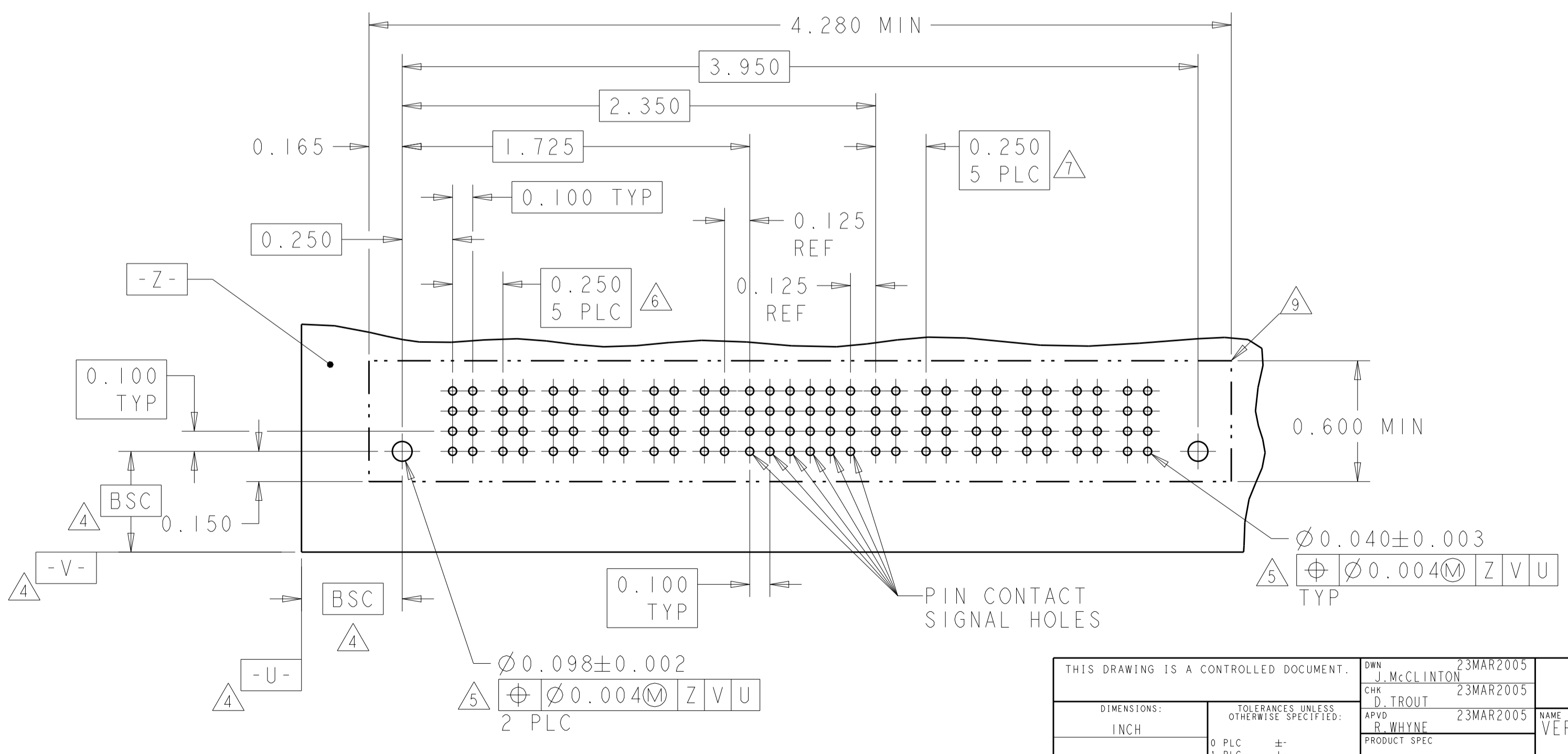

RECOMMENDED PCB LAYOUT I-6600333-3  
 SCALE 2:1

LOC	DIST	REV	DATE	BY	APPV
ES	00				

REVISIONS			
REV	DATE	BY	APPV
-	-	-	-
SEE SHEET 1			

THIS DRAWING IS A CONTROLLED DOCUMENT.

DIMENSIONS: INCH	TOLERANCES UNLESS OTHERWISE SPECIFIED:	OWN: J. McCLINTON 23MAR2005	CHK: D. TROUT 23MAR2005	APV: P. MLYNE 23MAR2005
0 PLC ±.01	1 PLC ±.01	NAME: VERTICAL HEADER ASSEMBLY, W/GUIDES, PRESS FIT, TYPE PSP MULTI-BEAM XL		
2 PLC ±.005	3 PLC ±.005	SIZE: CAGE CODE DRAWING NO: RESTRICTED TO		
4 PLC ±.002	ANGLES 2*	A100779C=6600333		
MATERIAL:	FINISH:	WEIGHT: 114-13038		
		Customer Drawing		

SCALE 3:1 SHEET 5 OF 22 REV P7

PART NUMBER	ROWS	POWER				SIGNAL								POWER			
		P1	P2	P3	P4	1	2	3	4	5	6	7	8	P5	P6	P7	P8
1-6600333-4	D	VM	VM	VM	VM	EV	EV	EV	EV	EV	EV	EV	EV	VM	VM	VM	VM
	C					EV	EV	EV	EV	EV	EV	EV					
	B					EV	EV	EV	EV	EV	EV	EV					
	A					EV	EV	EV	EV	EV	EV	EV					
4P+32S+4P		HD															

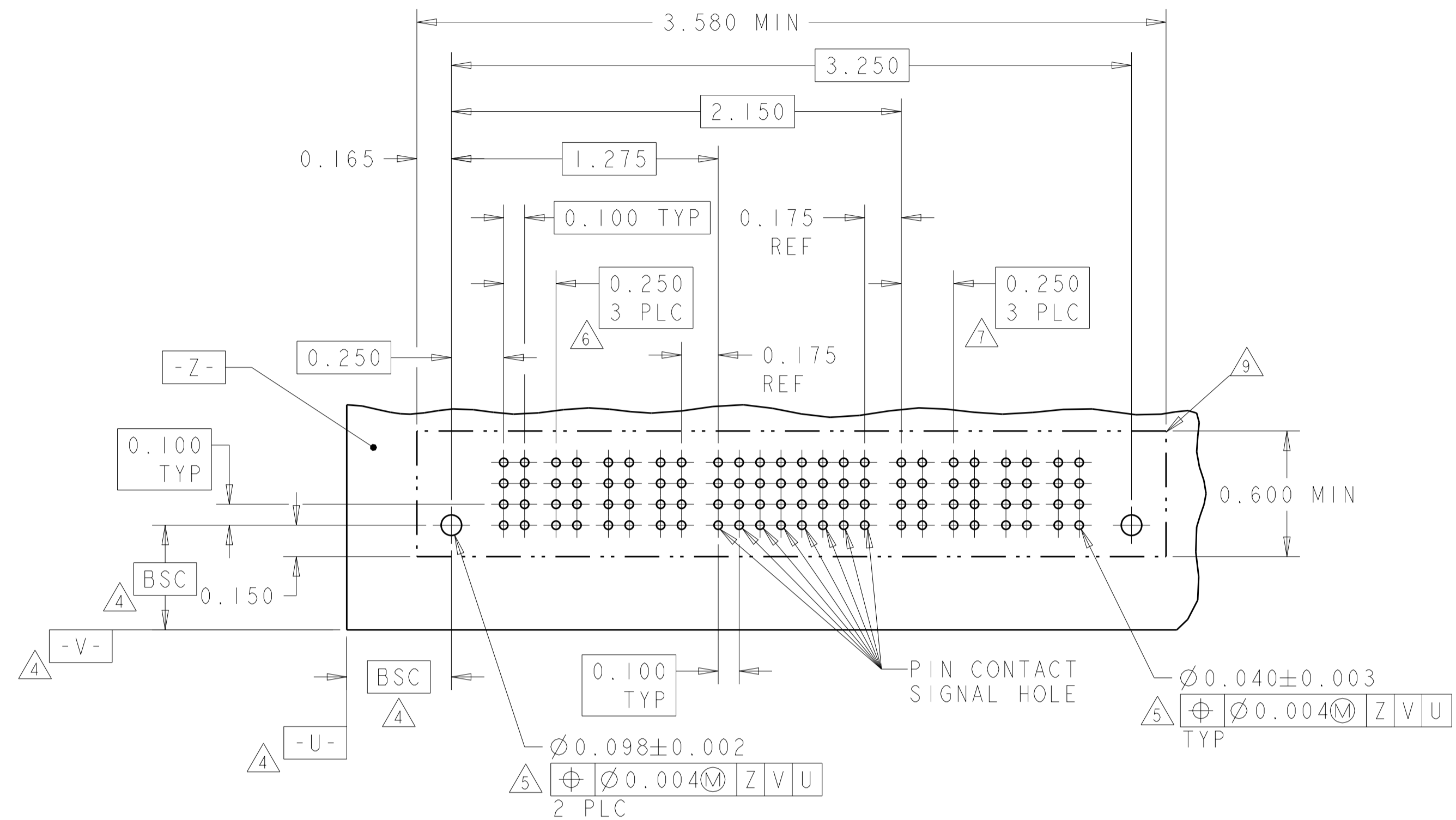

RECOMMENDED PCB LAYOUT 1-6600333-4  
SCALE 2:1

PART NUMBER	ROWS	POWER						SIGNAL						POWER					
		P1	P2	P3	P4	P5	P6	1	2	3	4	5	6	P7	P8	P9	P10	P11	P12
1-6600333-5	D	VM	VM	VM	VM	VM	VM	EV	EV	EV	EV	EV	VM	VM	VM	VM	VM	VM	VM
	C							EV	EV	EV	EV	EV							
	B							EV	EV	EV	EV	EV							
	A							EV	EV	EV	EV	ES							
6P+24S+6P		HD																	

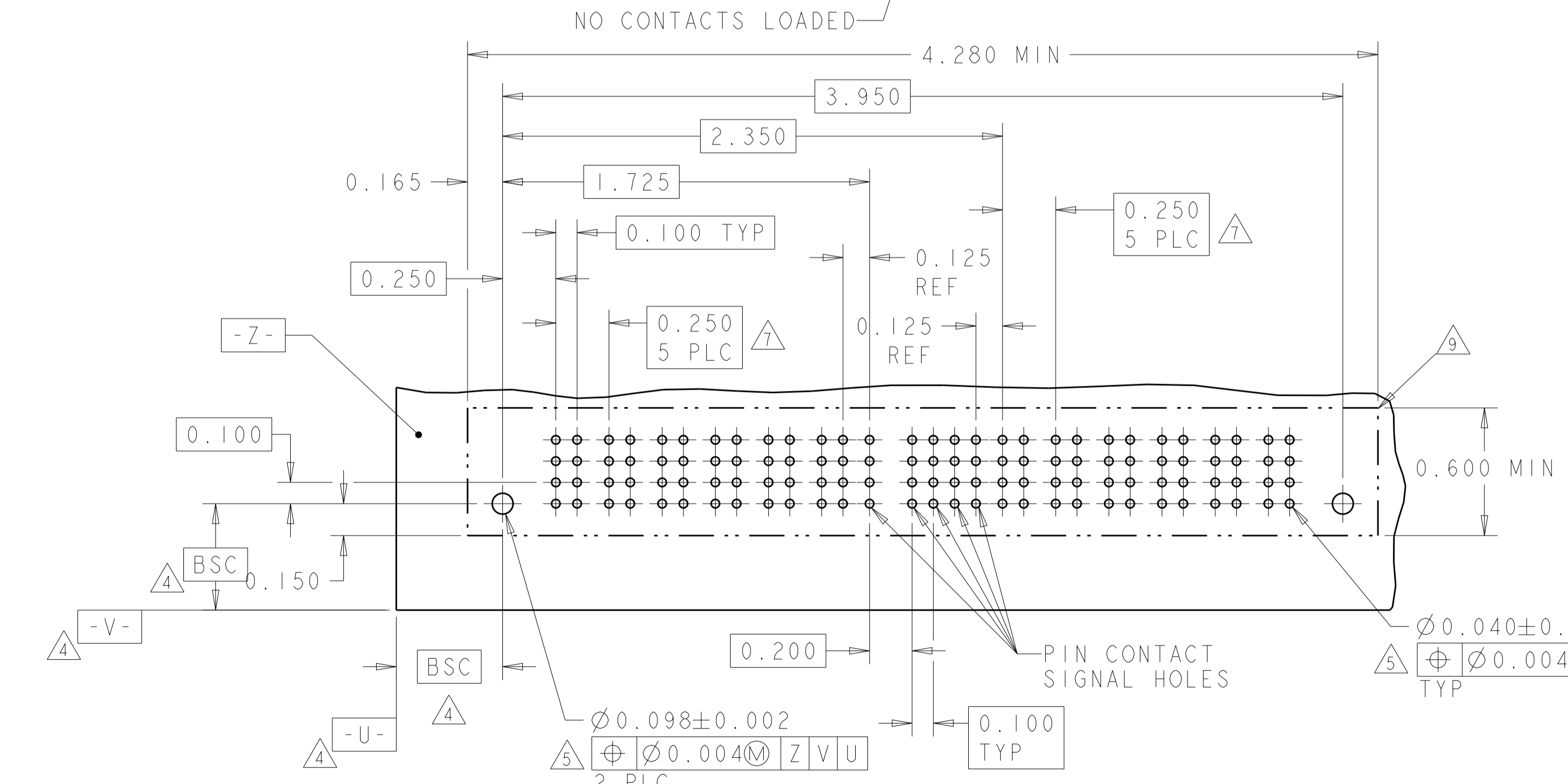

RECOMMENDED PCB LAYOUT 1-6600333-5  
SCALE 2:1

PART NUMBER	ROWS	POWER		SIGNAL						POWER		
		P1	P2	1	2	3	4	5	6	P3	P4	
1-6600333-6	D	VM	VM	ES	ES	ES	ES	ES	ES	EV	VM	VM
	C			ES	EV	EV	EV	EV	ES			
	B			ES	ES	ES	ES	ES	ES			
	A			ES	ES	ES	ES	ES	EV			
2P+24S+2P		HD										

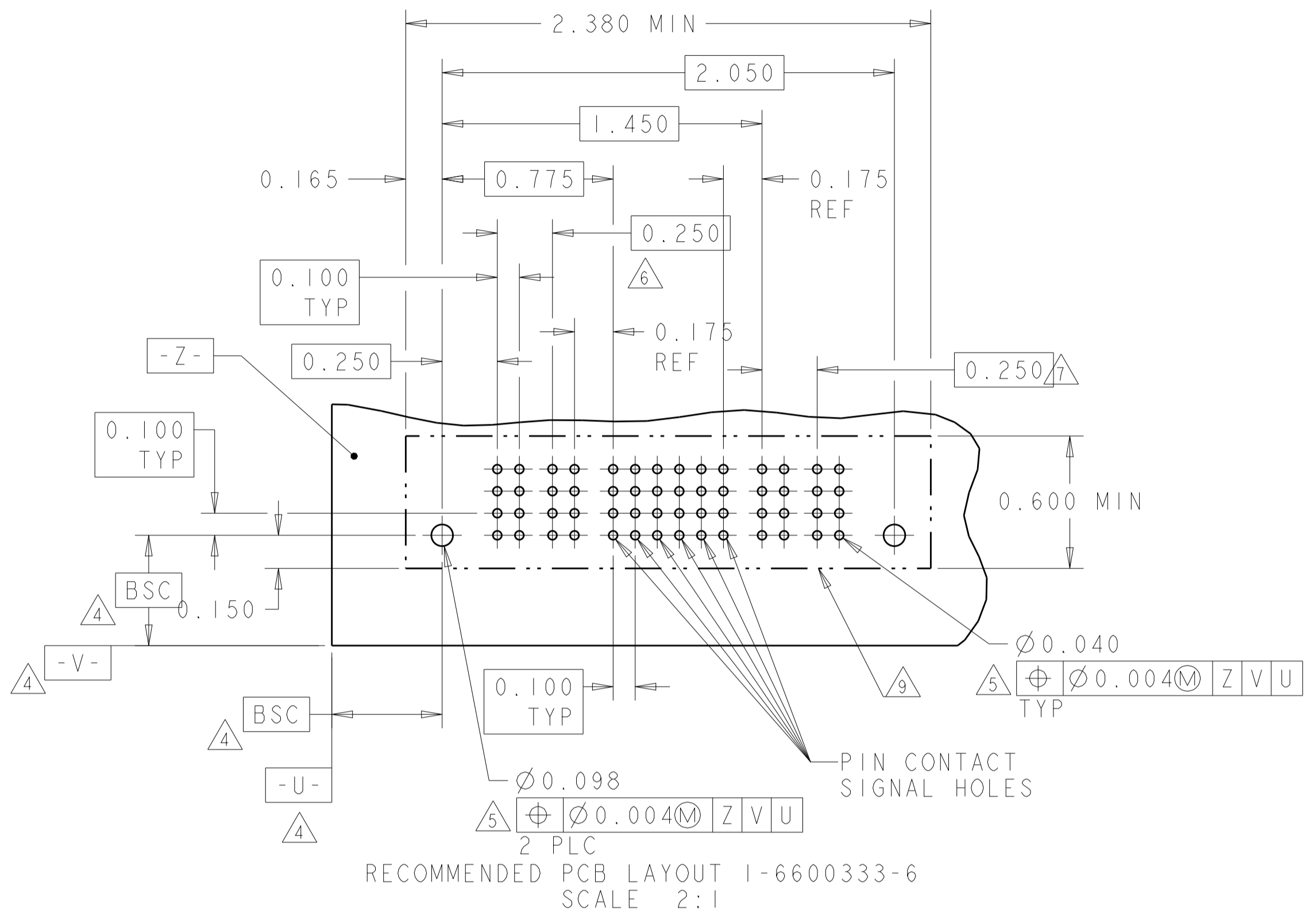

RECOMMENDED PCB LAYOUT 1-6600333-6  
SCALE 2:1

PART NUMBER	ROWS	POWER						SIGNAL						POWER							
		P1	P2	P3	P4	P5	P6	1	2	3	4	5	6	P7	P8	P9	P10	P11	P12	P13	P14
2-6600333-1	D	VM	VM	VM	VM	VM	VM	EV	EV	EV	EV	EV	EV	VM	VM	VM	VM	VM	VM	VM	
	C							EV	EV	EV	EV	EV									
	B							EV	EV	EV	EV	EV									
	A							EV	EV	EV	EV	EV									
6ACP + 24S + 8P		HD																			

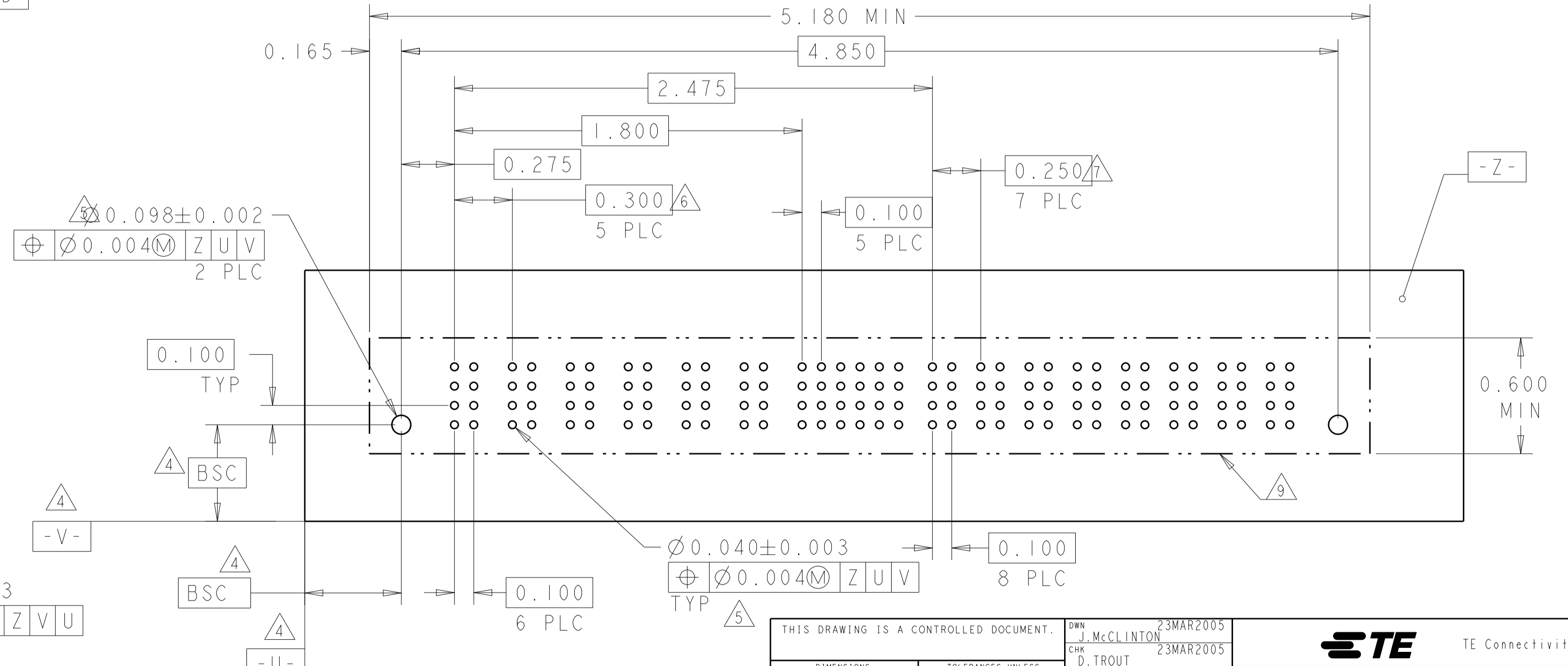

THIS DRAWING IS A CONTROLLED DOCUMENT.

DIMENSIONS: INCH	TOLERANCES UNLESS OTHERWISE SPECIFIED:	OWN: J. McCLINTON 23MAR2005	CHK: D. TROUT 23MAR2005	APVD: B. MLYNE 23MAR2005
0 PLC ±.01	1 PLC ±.01	PRODUCT SPEC	NAME: VERTICAL HEADER ASSEMBLY, W/GUIDES, PRESS FIT, TYPE PSP MULTI-BEAM XL	
2 PLC ±.005	3 PLC ±.005	APPLICATION SPEC	SIZE: 108-1973	RESTRICTED TO
4 PLC ±.0020	ANGLES ±.0020	WEIGHT: 114-13038	SCALE: 3:1	SHEET 6 OF 22
MATERIAL:	FINISH:	Customer Drawing	SCALE: 3:1	REV: P7

LOC	DIST	REV	DATE	BY	APPV
ES	00				

REV	DATE	DESCRIPTION
1		SEE SHEET 1

LOC	DIST	REV	DATE	BY	APPV
ES	00				

REVISIONS			
REV	DATE	DESCRIPTION	BY
-	-	SEE SHEET 1	-

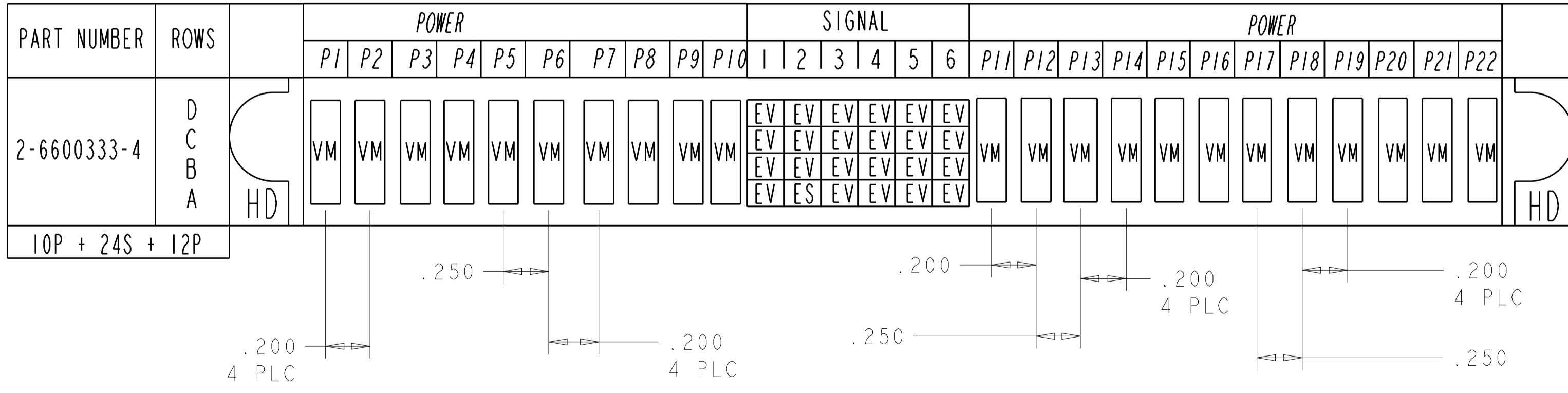
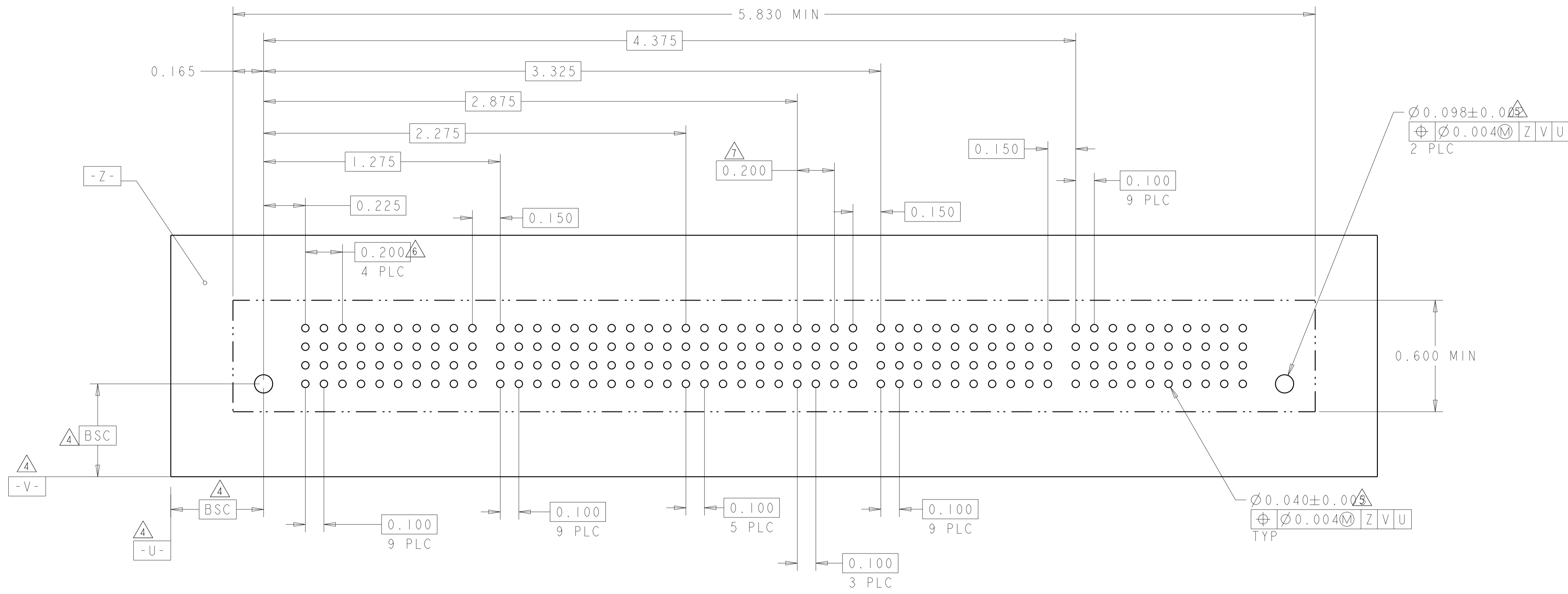
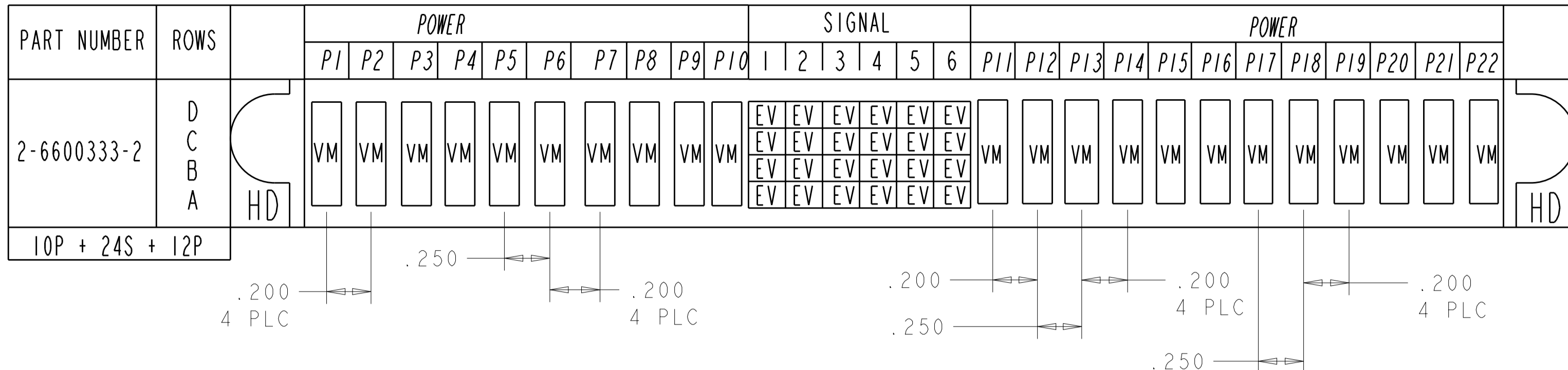

THE PART NUMBER 2-6600333-4 PCB LAYOUT IS SAME AS 2-6600333-2

THIS DRAWING IS A CONTROLLED DOCUMENT.		OWN: J. McCLINTON 23MAR2005	 TE Connectivity										
DIMENSIONS: INCH		CHK: D. TROUT 23MAR2005											
TOLERANCES UNLESS OTHERWISE SPECIFIED:		APV: B. WHYNE 23MAR2005	NAME: VERTICAL HEADER ASSEMBLY, W/GUIDES, PRESS FIT, TYPE PSP MULTI-BEAM XL										
<table border="1"> <tr> <td>0 PLC</td><td>±</td></tr> <tr> <td>1 PLC</td><td>±.01</td></tr> <tr> <td>3 PLC</td><td>±.005</td></tr> <tr> <td>4 PLC</td><td>±.002</td></tr> <tr> <td>ANGLES</td><td>±.02°</td></tr> </table>		0 PLC	±	1 PLC	±.01	3 PLC	±.005	4 PLC	±.002	ANGLES	±.02°	PRODUCT SPEC: 108-1973	SIZE: A1
0 PLC	±												
1 PLC	±.01												
3 PLC	±.005												
4 PLC	±.002												
ANGLES	±.02°												
MATERIAL: -		APPLICATION SPEC: 114-13038	CAGE CODE: 6600333										
FINISH: -		WEIGHT: -	RESTRICTED TO: -										
Customer Drawing		SCALE: 3:1	SHEET 7 OF 22 REV P7										



LOC	DIST	REVISIONS			
P	LTN	DESCRIPTION	DATE	DMN	APVD
-	-	SEE SHEET 1	-	-	-

PART NUMBER	ROWS	SIGNAL																POWER											SIGNAL											POWER										
		1	2	3	4	5	6	7	8	9	10	11	12	13	14	15	16	PI1	P2	P3	P4	P5	P6	P7	P8	P9	PI10	PI11	17	18	19	20	21	PI2	PI3	PI4	PI5	PI6	PI7	PI8	PI9	P20	P21	P22	P23	P24	P25	P26		
2-6600333-3	D	EV	EV	EV	EV	EV	EV	EV	EV	EV	EV	EV	EV	EV	EV	EV	VM	VM	VM	VM	VM	VM	VM	VM	VM	VM	VM	EV	EV	EV	EV	EV	VM	VM	VM	VM	VM	VM	VM	VM	VM	VM	VM	VM	VM	VM	VM	VM		
	C	EV	EV	EV	EV	EV	EV	EV	EV	EV	EV	EV	EV	EV	EV	EV	VM	VM	VM	VM	VM	VM	VM	VM	VM	VM	EV	EV	EV	EV	EV	VM	VM	VM	VM	VM	VM	VM	VM	VM	VM	VM	VM	VM	VM	VM				
	B	EV	EV	EV	EV	EV	EV	EV	EV	EV	EV	EV	EV	EV	EV	EV	VM	VM	VM	VM	VM	VM	VM	VM	VM	VM	EV	EV	EV	EV	EV	VM	VM	VM	VM	VM	VM	VM	VM	VM	VM	VM	VM	VM	VM	VM				
	A	EV	EV	EV	EV	EV	EV	EV	EV	EV	EV	EV	EV	EV	EV	EV	VM	VM	VM	VM	VM	VM	VM	VM	VM	VM	EV	EV	EV	EV	EV	VM	VM	VM	VM	VM	VM	VM	VM	VM	VM	VM	VM	VM	VM	VM				
64S+11P+20S+15P	HD																																	HD																

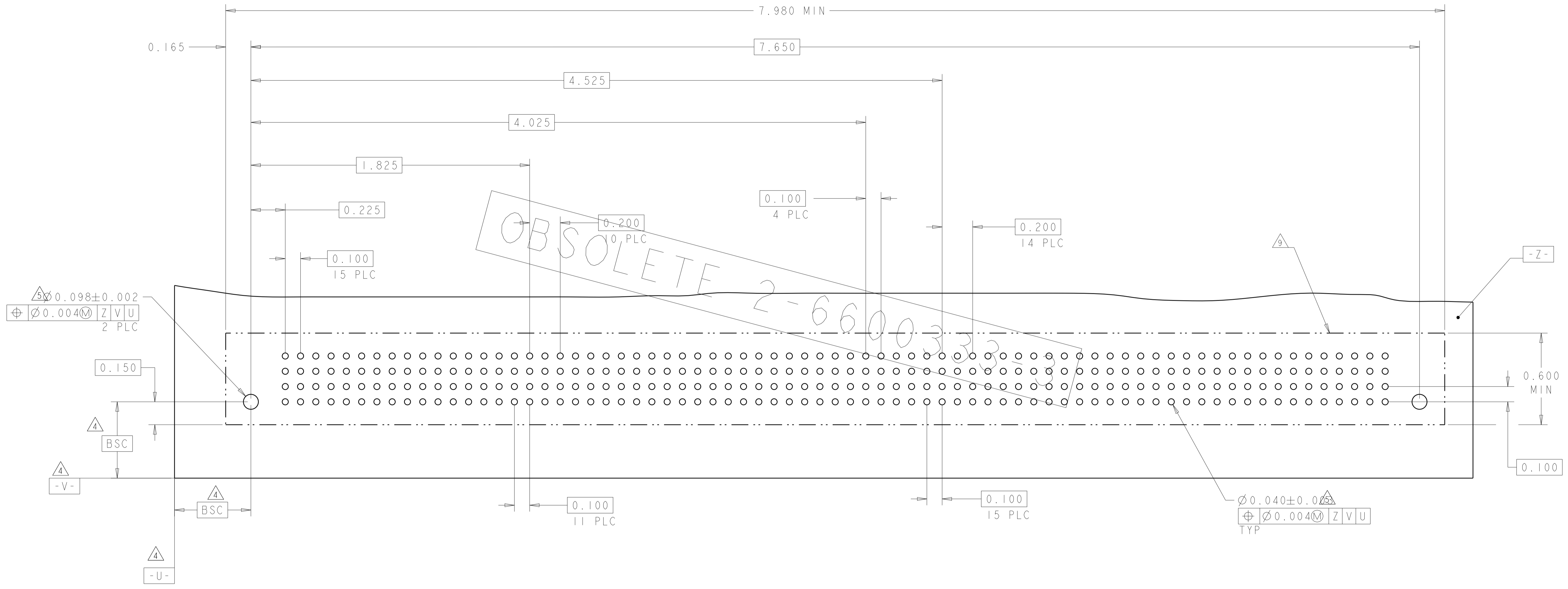

THIS DRAWING IS A CONTROLLED DOCUMENT.		DMN J. McCLINTON 23MAR2005	 TE Connectivity										
DIMENSIONS: INCH		CHK D. TROUT 23MAR2005											
TOLERANCES UNLESS OTHERWISE SPECIFIED:		APVD B. WHYNE 23MAR2005	NAME VERTICAL HEADER ASSEMBLY, W/GUIDES, PRESS FIT, TYPE PSP MULTI-BEAM XL										
<table border="1"> <tr><td>0 PLC</td><td>±</td></tr> <tr><td>1 PLC</td><td>±.01</td></tr> <tr><td>3 PLC</td><td>±.005</td></tr> <tr><td>4 PLC</td><td>±.0020</td></tr> <tr><td>ANGLES</td><td>±.0020</td></tr> </table>		0 PLC	±	1 PLC	±.01	3 PLC	±.005	4 PLC	±.0020	ANGLES	±.0020	PRODUCT SPEC 108-1973	SIZE A100779
0 PLC	±												
1 PLC	±.01												
3 PLC	±.005												
4 PLC	±.0020												
ANGLES	±.0020												
MATERIAL		APPLICATION SPEC 114-13038	RESTRICTED TO										
FINISH		WEIGHT	SCALE 3:1										
		Customer Drawing	SHEET 8 OF 22										
			REV P7										

LOC		DIST		REVISIONS			
ES	00	P	LTN	DESCRIPTION	DATE	DMN	APVD
		-		SEE SHEET 1			

PART NUMBER	ROWS	POWER				SIGNAL				POWER		
		P1	P2	P3	P4	1	2	3	4	P5	P6	P7
2-6600333-5	D	VM	VM	VM	VM	EV	EV	EV	EV	VM	VM	VM
	C					EV	EV	EV	EV			
	B					EV	EV	EV	EV			
	A					ES	EV	EV	EV			
4P+16S+3P		HD										HD

PART NUMBER	ROWS	POWER			SIGNAL						POWER		
		P1	P2	P3	1	2	3	4	5	6	P4	P5	P6
2-6600333-6	D	VM	VM	VM	EV	EV	EV	EV	EV	EV	VM	VM	VM
	C				EV	EV	EV	EV	EV				
	B				EV	EV	EV	EV	EV				
	A				ES	EV	EV	EV	EV				
3P+24S+3P		HD											HD

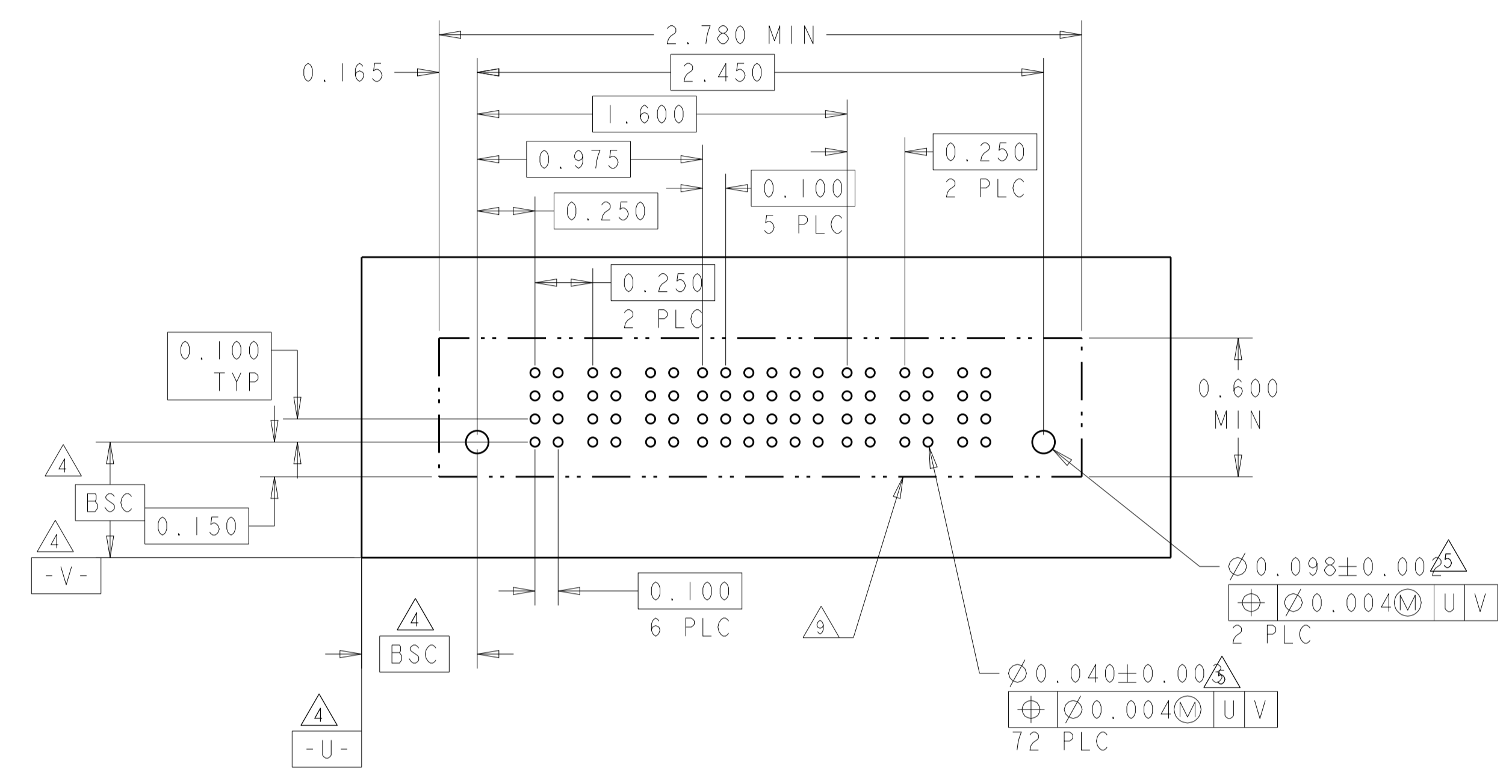
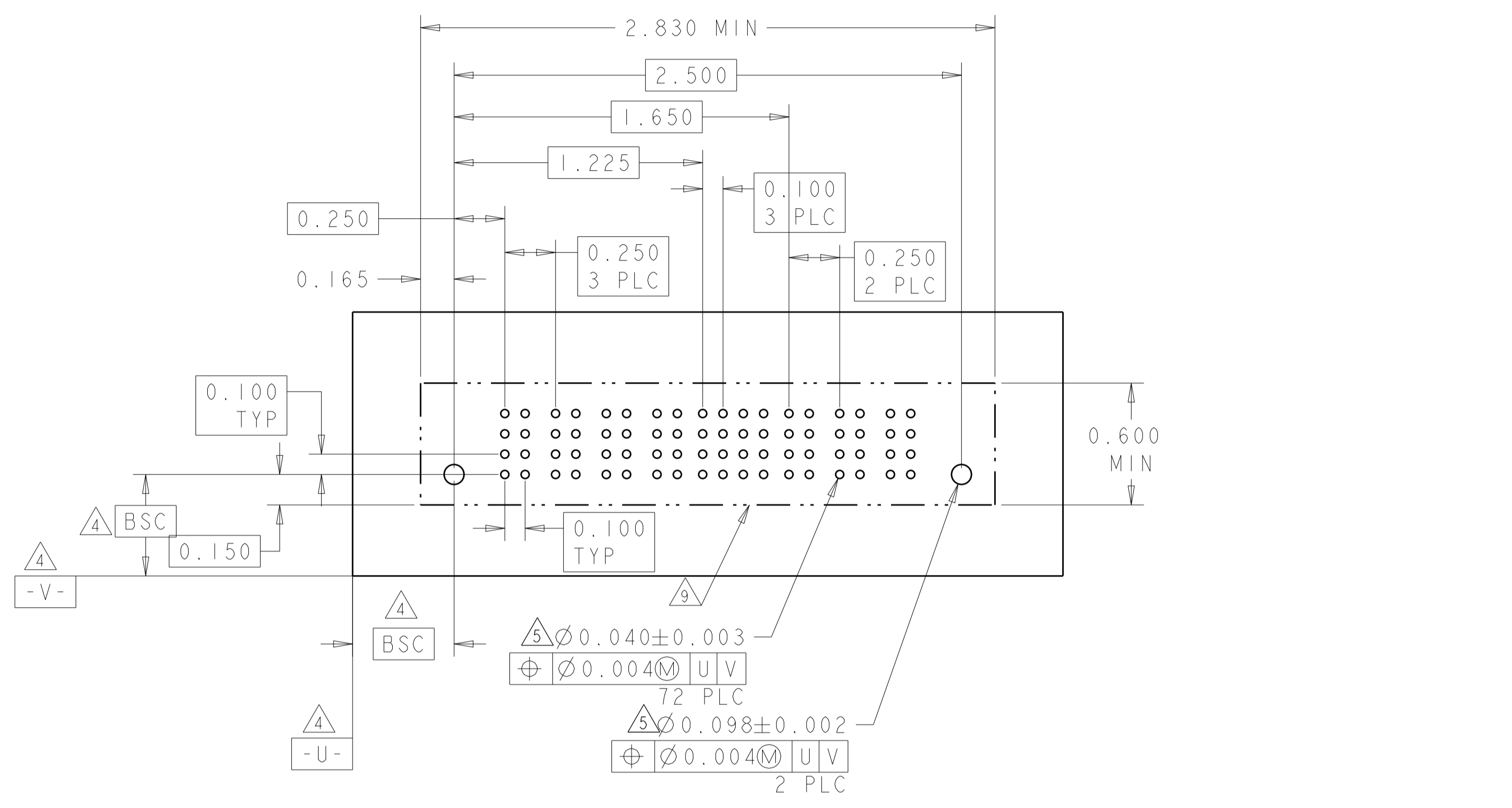

PART NUMBER	ROWS	POWER				SIGNAL						POWER					
		P1	P2	P3	P4	1	2	3	4	5	6	P5	P6	P7	P8	P9	
2-6600333-7	D	VM	VM	VM	VM	ES	EV	ES	EV	ES	EV	VM	VM	VM	VM	VM	
	C					EV	EV	EV	ES	EV							
	B					EV	ES	EV	EV	EV							
	A					ES	ES	EV	EV	ES							
4P+24S+5P		HD															HD

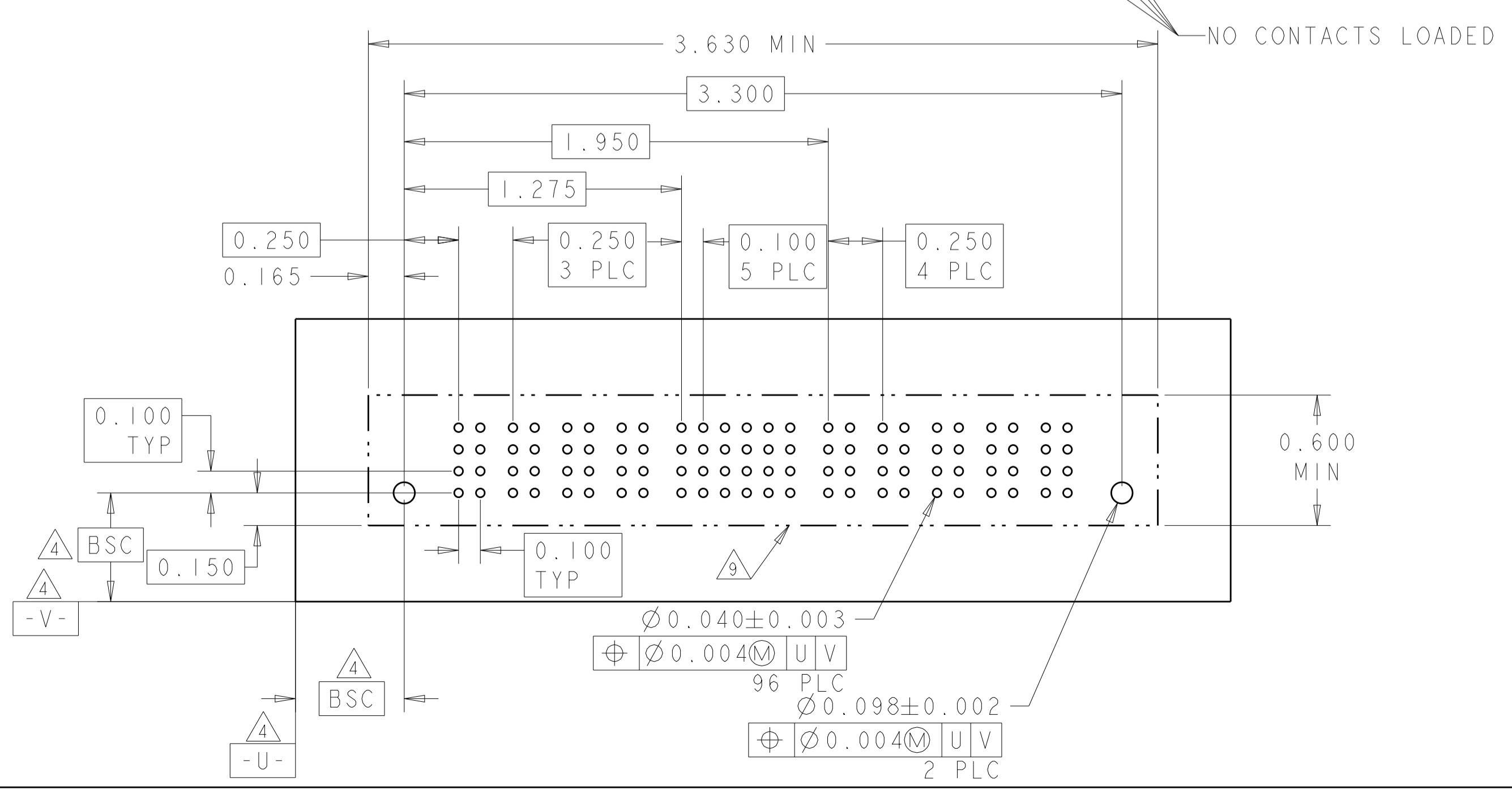

THIS DRAWING IS A CONTROLLED DOCUMENT.

DIMENSIONS: INCH	TOLERANCES UNLESS OTHERWISE SPECIFIED:	DMN: J. McCLINTON 23MAR2005	CHK: D. TROUT 23MAR2005	APVD: B. WHYNE 23MAR2005
0 PLC ±.01	1 PLC ±.01	2 PLC ±.01	3 PLC ±.005	4 PLC ±.002
ANGLES: ±.2°		PRODUCT SPEC: 108-1973	APPLICATION SPEC: 114-13038	WEIGHT: -
MATERIAL: -	FINISH: -	SIZE: A100779	CAGE CODE: 6600333	RESTRICTED TO: -

Customer Drawing SCALE 3:1 SHEET 9 OF 22 REV P7

**STE** TE Connectivity  
 VERTICAL HEADER ASSEMBLY, W/GUIDES, PRESS FIT, TYPE PSP MULTI-BEAM XL

LOC	DIST	REVISIONS			
P	LTN	DESCRIPTION	DATE	DMN	APVD
ES	00	SEE SHEET 1	-	-	-

PART NUMBER	ROWS	POWER				SIGNAL				POWER		
		P1	P2	P3	P4	1	2	3	4	P5	P6	P7
2-6600333-8	D	VM	VM	VM	VM	ES	ES	EV	EV	VM	VM	VM
	C					ES	EV	EV	EV			
	B					ES	EV	EV	EV			
	A					EV	EV	ES	ES			
4P+16S+3P												HD

PART NUMBER	ROWS	POWER		SIGNAL								POWER			
		P1	P2	1	2	3	4	5	6	7	8	P3	P4		
2-6600333-9	D	VM	VM	ES	EV	EV	EV	EV	EV	EV	EV	EV	EV	VM	
	C			EV	EV	EV	EV	EV	EV	EV	EV				
	B			EV	EV	EV	EV	EV	EV	EV	EV				
	A			ES	EV	EV	EV	EV	EV	EV	ES				
2P+32S+2P															HD

NO CONTACT LOADED

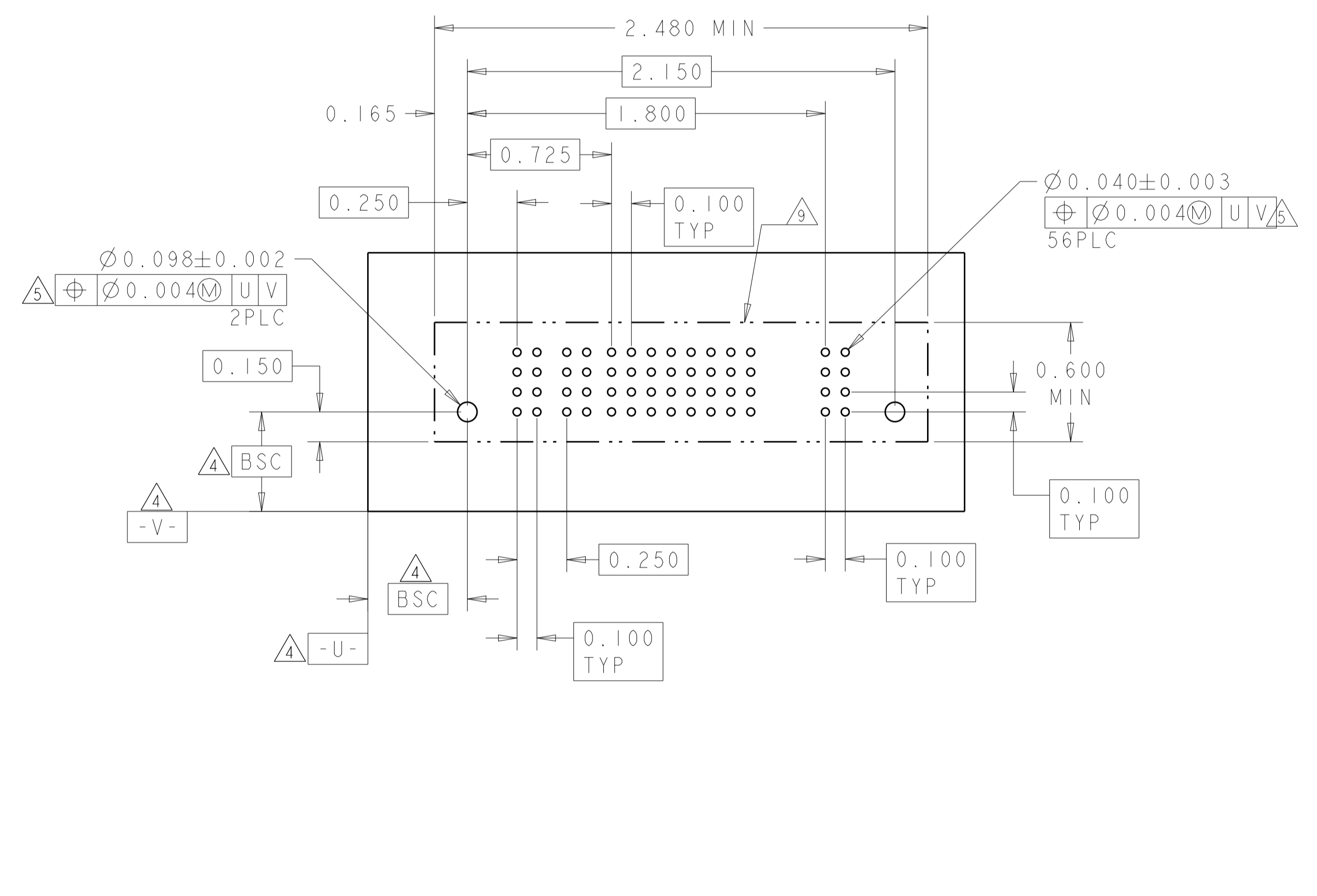
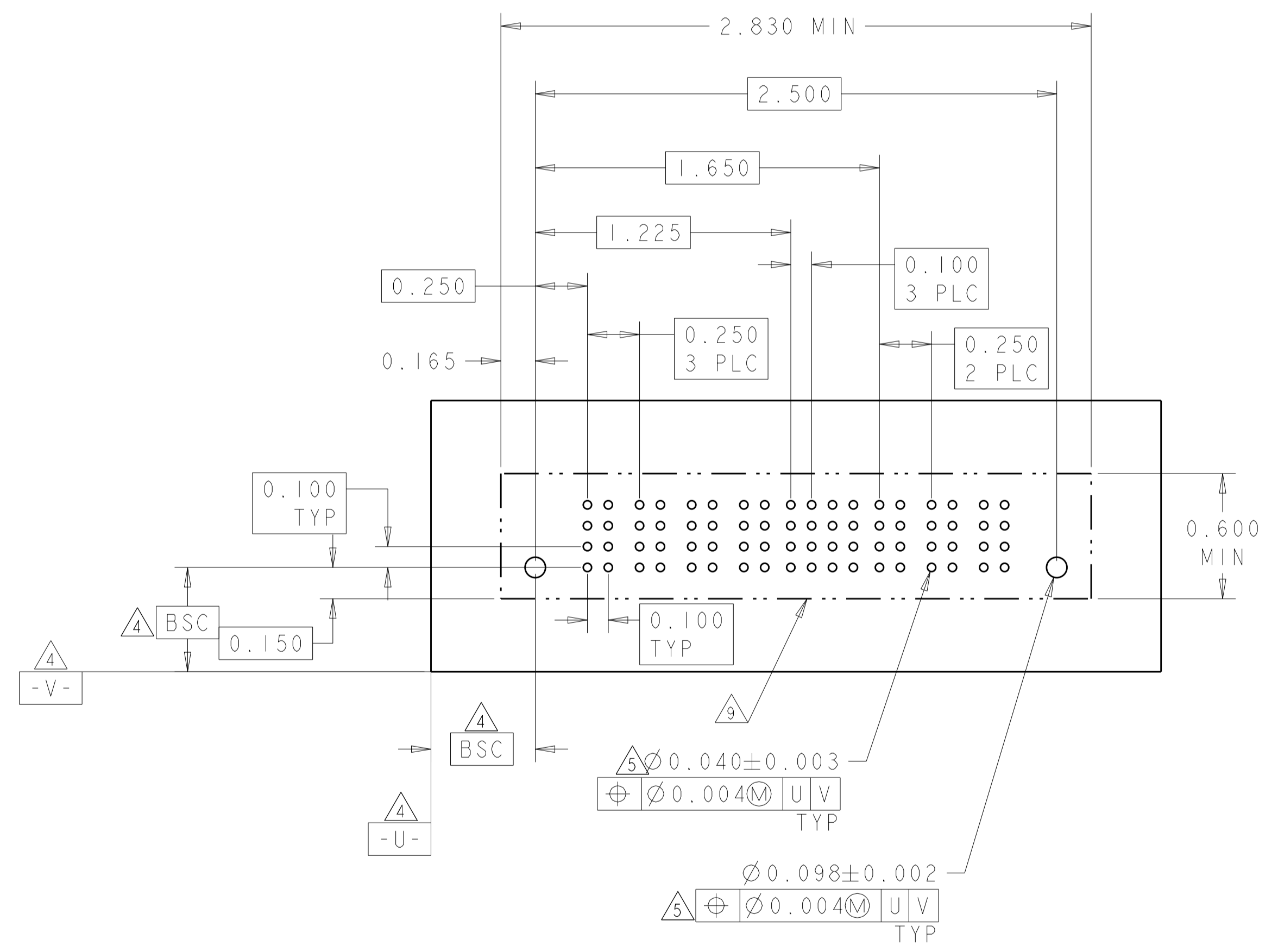

THIS DRAWING IS A CONTROLLED DOCUMENT.		DMN J. McCLINTON 23MAR2005	TE Connectivity										
DIMENSIONS: INCH		CHK D. TROUT 23MAR2005											
TOLERANCES UNLESS OTHERWISE SPECIFIED:		APVD B. MLYNE 23MAR2005	NAME VERTICAL HEADER ASSEMBLY, W/GUIDES, PRESS FIT, TYPE PSP MULTI-BEAM XL										
<table border="1"> <tr> <td>0 PLC</td> <td>±</td> </tr> <tr> <td>2 PLC</td> <td>±.01</td> </tr> <tr> <td>3 PLC</td> <td>±.005</td> </tr> <tr> <td>4 PLC</td> <td>±.0020</td> </tr> <tr> <td>ANGLES</td> <td>±.020</td> </tr> </table>		0 PLC	±	2 PLC	±.01	3 PLC	±.005	4 PLC	±.0020	ANGLES	±.020	PRODUCT SPEC 108-1973	SIZE A100779
0 PLC	±												
2 PLC	±.01												
3 PLC	±.005												
4 PLC	±.0020												
ANGLES	±.020												
MATERIAL		APPLICATION SPEC 114-13038	CAGE CODE C=6600333										
FINISH		WEIGHT	RESTRICTED TO										
		Customer Drawing	SCALE 3:1 SHEET 10 OF 22 REV P7										

LOC		DIST		REVISIONS			
ES	00	P	LTN	DESCRIPTION	DATE	DMN	APVD
-	-	-	-	SEE SHEET 1	-	-	-

PART NUMBER	ROWS	POWER						SIGNAL						POWER							
		P1	P2	P3	P4	P5	P6	1	2	3	4	5	6	P7	P8	P9	P10	P11	P12	P13	P14
3-6600333-1	D	VM	VM	VM	VM	VM	EV	EV	EV	EV	EV	EV	VM	VM	VM	VM	VM	VM			
	C						EV	EV	EV	EV	EV	EV									
	B						EV	EV	EV	EV	EV	EV									
	A						ES	ES	EV	EV	EV	EV									
6ACP + 24S + 8P		HD																			

PART NUMBER	ROWS	POWER				SIGNAL						POWER			
		P1	P2	P3	P4	1	2	3	4	5	6	P5	P6	P7	P8
3-6600333-2	D	VM	VM	VM	VM	EV	EV	EV	EV	EV	EV	VM	VM	VM	VM
	C					EV	EV	EV	EV	EV	EV				
	B					EV	EV	EV	EV	EV	EV				
	A					EV	EV	EV	EV	EV	EV				
4P+24S+4P		HD													

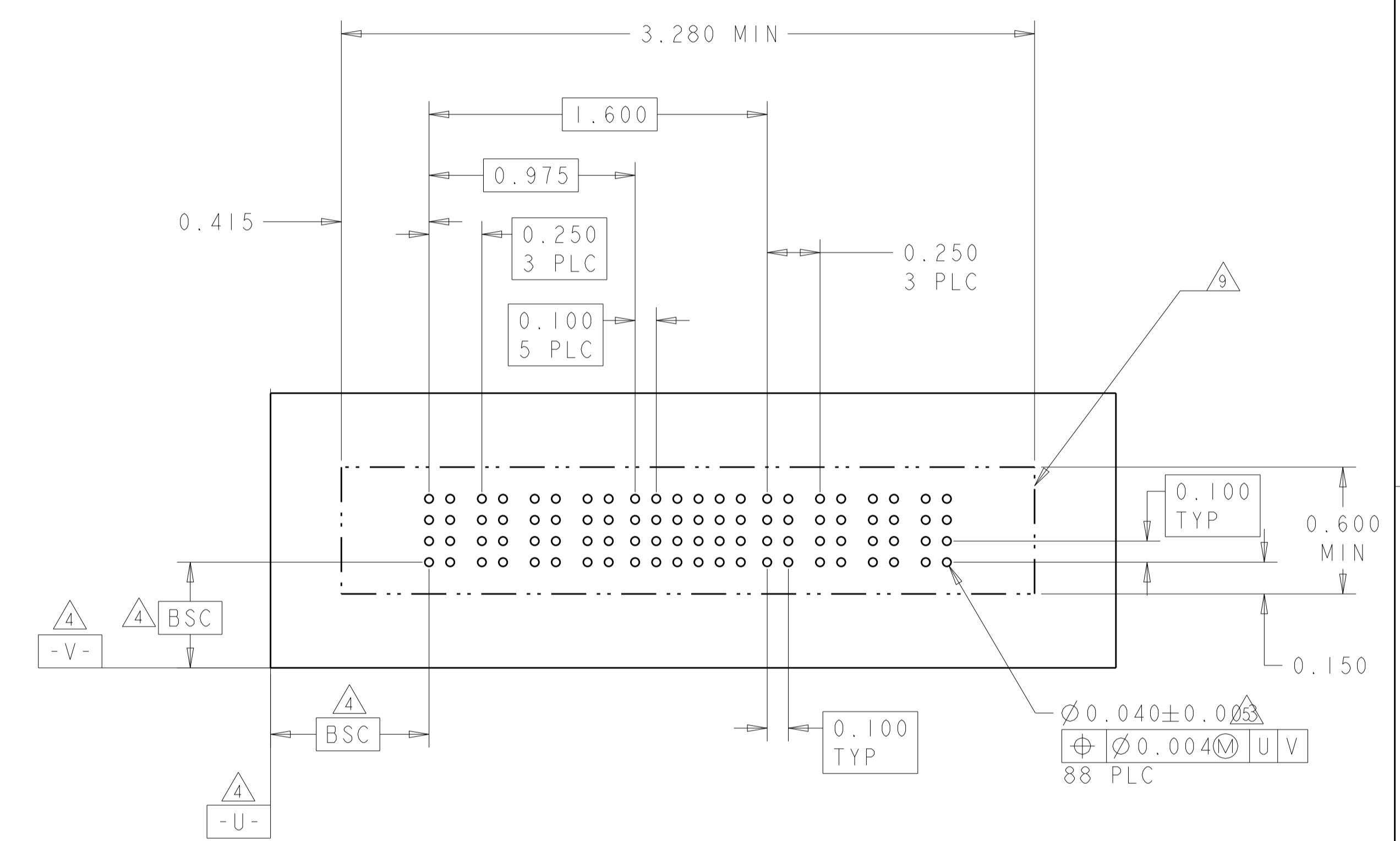
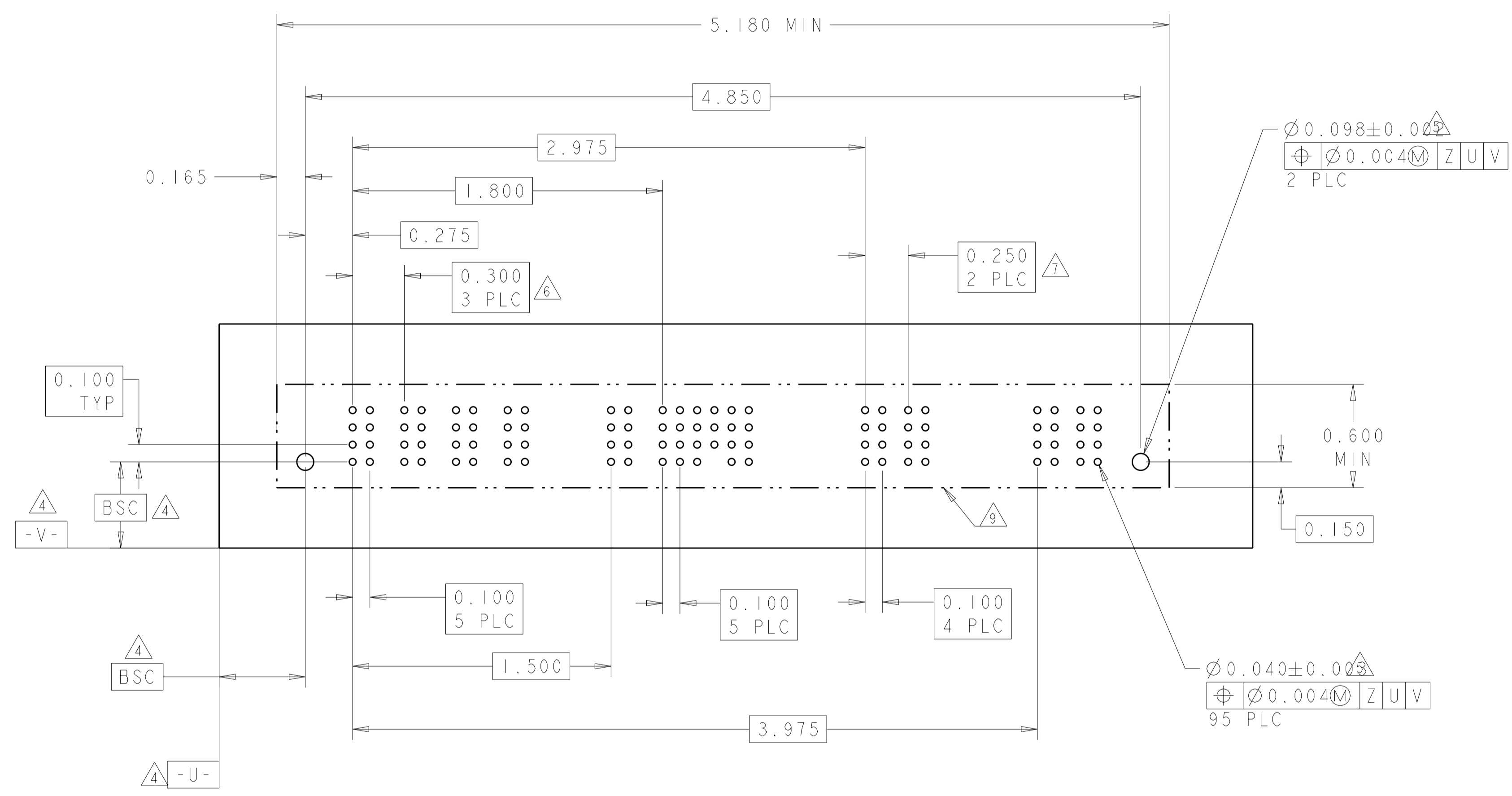

THIS DRAWING IS A CONTROLLED DOCUMENT.

DIMENSIONS:	TOLERANCES UNLESS OTHERWISE SPECIFIED:	DMN	J. McCLINTON	23MAR2005
INCH	0 PLC ±	CHK	D. TROUT	23MAR2005
	1 PLC ±.01	APVD	P. WHYNE	23MAR2005
	2 PLC ±.01	PRODUCT SPEC		
	3 PLC ±.005	APPLICATION SPEC		
	4 PLC ±.0020	SIZE	114-13038	
	ANGLES ±.020	WEIGHT		
MATERIAL	FINISH	Customer Drawing		

NAME: VERTICAL HEADER ASSEMBLY, W/GUIDES, PRESS FIT, TYPE PSP MULTI-BEAM XL

SIZE: A1 00779 C=6600333

SCALE: 3:1 SHEET 11 OF 22 REV P7

LOC	DIST	REV	DATE	BY	APP'D
ES	00				
REVISIONS			DESCRIPTION	DATE	BY
			SEE SHEET 1		

PART NUMBER	ROWS	POWER				SIGNAL		POWER			
		P1	P2	P3	P4	1	2	P5	P6	P7	P8
3-6600333-4	D C B A	VM	VM	VM	VM	EV	EV	VM	VM	VM	VM
4P + 8S + 4P											

PART NUMBER	ROWS	POWER				SIGNAL				POWER			
		P1	P2	P3	P4	1	2	3	4	P5	P6	P7	P8
3-6600333-3	D C B A	VM	VM	VM	VM	EV	EV	EV	EV	VM	VM	VM	VM
4P + 16S + 4P													

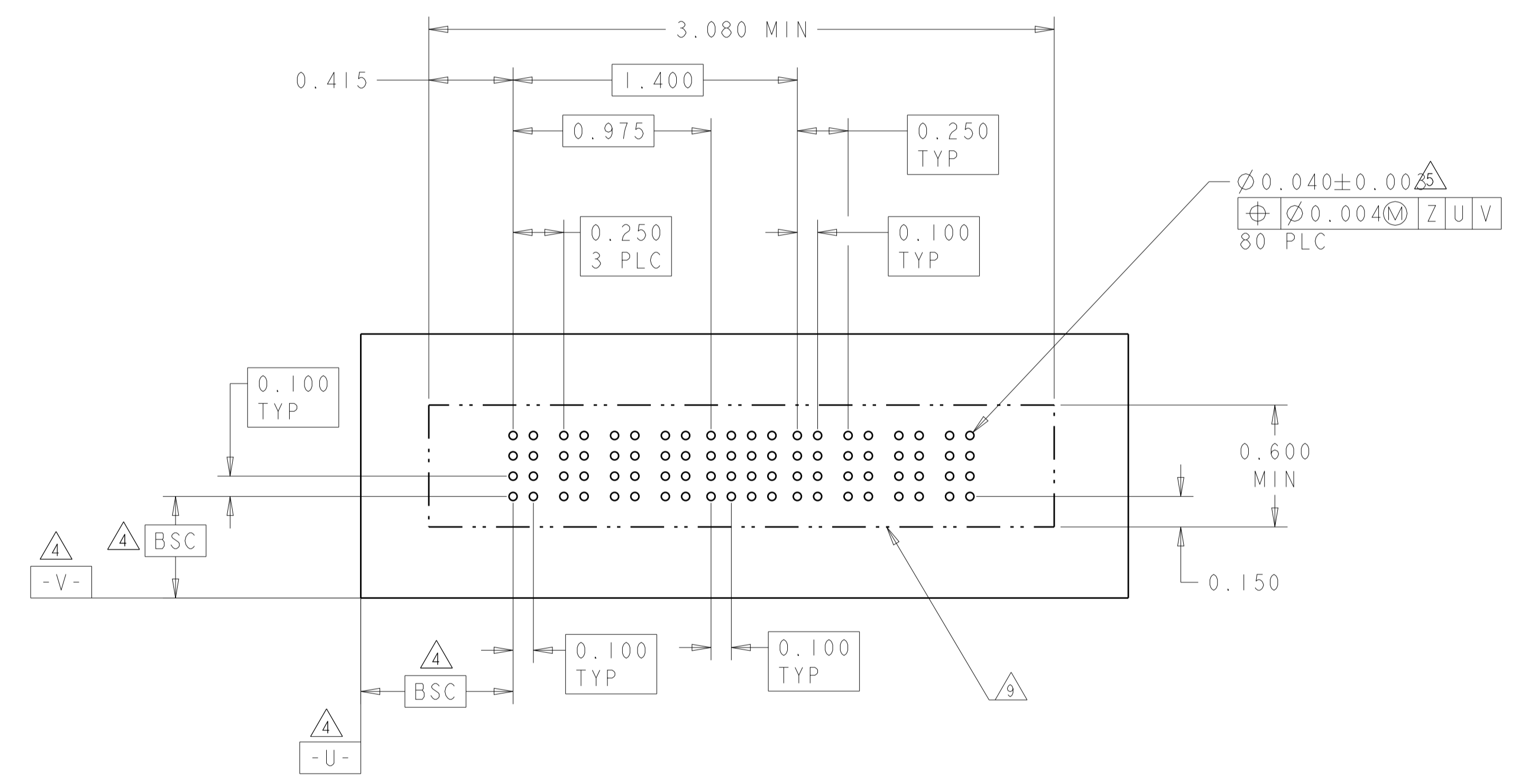
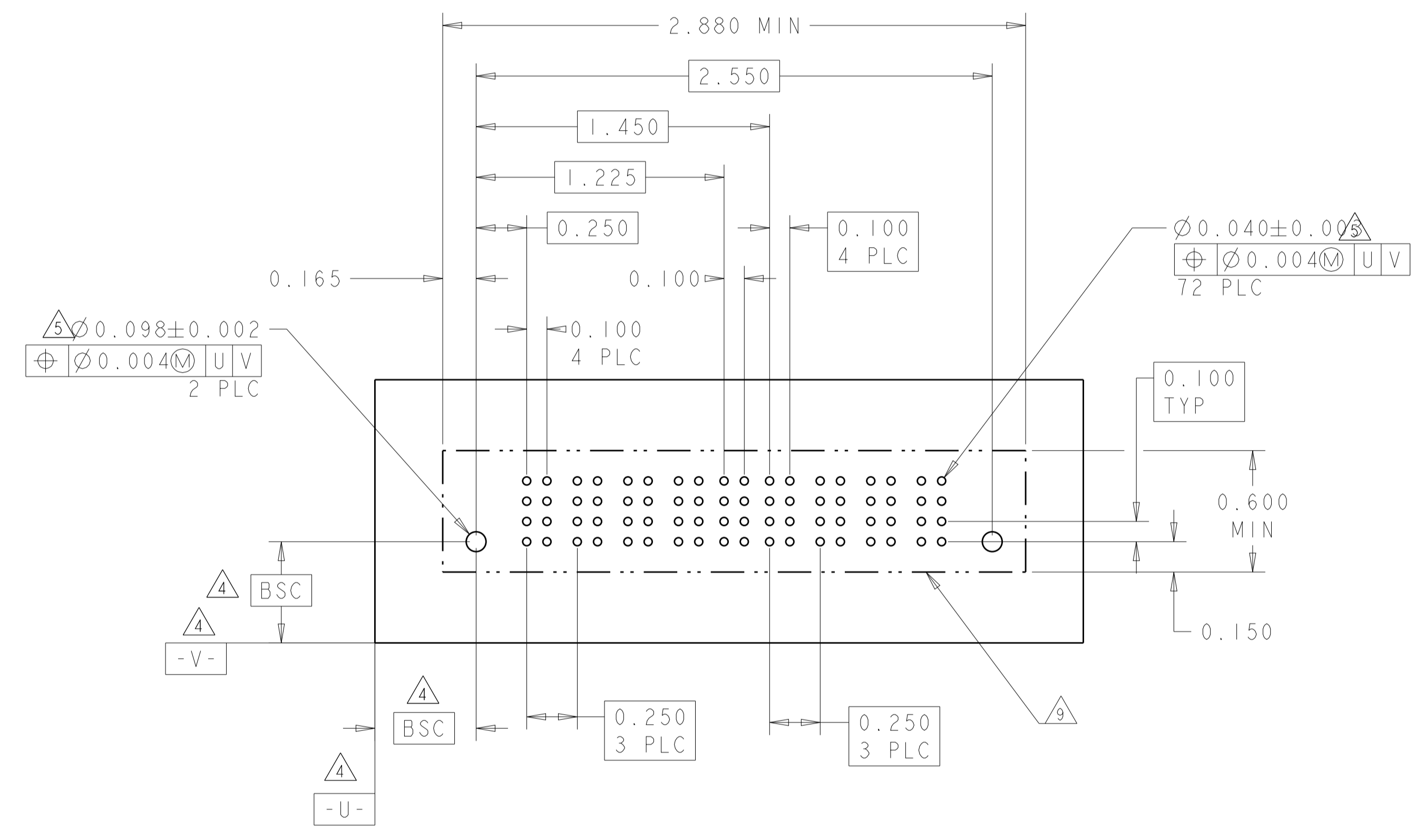

THIS DRAWING IS A CONTROLLED DOCUMENT.

DIMENSIONS:	TOLERANCES UNLESS OTHERWISE SPECIFIED:	OWN	J. McCLINTON	23MAR2005
INCH	0 PLC ±	CHK	D. TROUT	23MAR2005
	1 PLC ±.01	APP'D	B. WHYNE	23MAR2005
	3 PLC ±.005	PRODUCT SPEC		
	4 PLC ±.0020	APPLICATION SPEC		
	ANGLES ±.020	SIZE	114-13038	
MATERIAL	FINISH	WEIGHT		
		Customer Drawing		

**STE** TE Connectivity

NAME: VERTICAL HEADER ASSEMBLY, W/GUIDES, PRESS FIT, TYPE PSP MULTI-BEAM XL

SIZE: A100779 C=6600333

SCALE: 3:1 SHEET 12 OF 22 REV P7

LOC	DIST	REV	DATE	BY	APPD
ES	00				
REVISIONS			DESCRIPTION	DATE	BY
			SEE SHEET 1		

PART NUMBER	ROWS	POWER			SIGNAL						POWER		
		P1	P2	P3	1	2	3	4	5	6	P4	P5	P6
3-6600333-5	D	VM	VM	VM	EV	EV	EV	EV	EV	EV	VM	VM	VM
	C				EV	EV	EV	EV	EV	EV			
	B				EV	EV	EV	EV	EV	EV			
	A				EV	EV	EV	EV	EV	EV			
3P+24S+3P													

(K1)

PART NUMBER	ROWS	POWER		SIGNAL						POWER	
		P1	P2	1	2	3	4	5	6	P3	P4
3-6600333-7	D	VM	VM	ES	EV	EV	EV	EV	EV	VM	VM
	C			ES	EV	EV	EV	EV	EV		
	B			EV	EV	EV	EV	EV	EV		
	A			ES	EV	EV	EV	EV	EV		
2P+24S+2P											

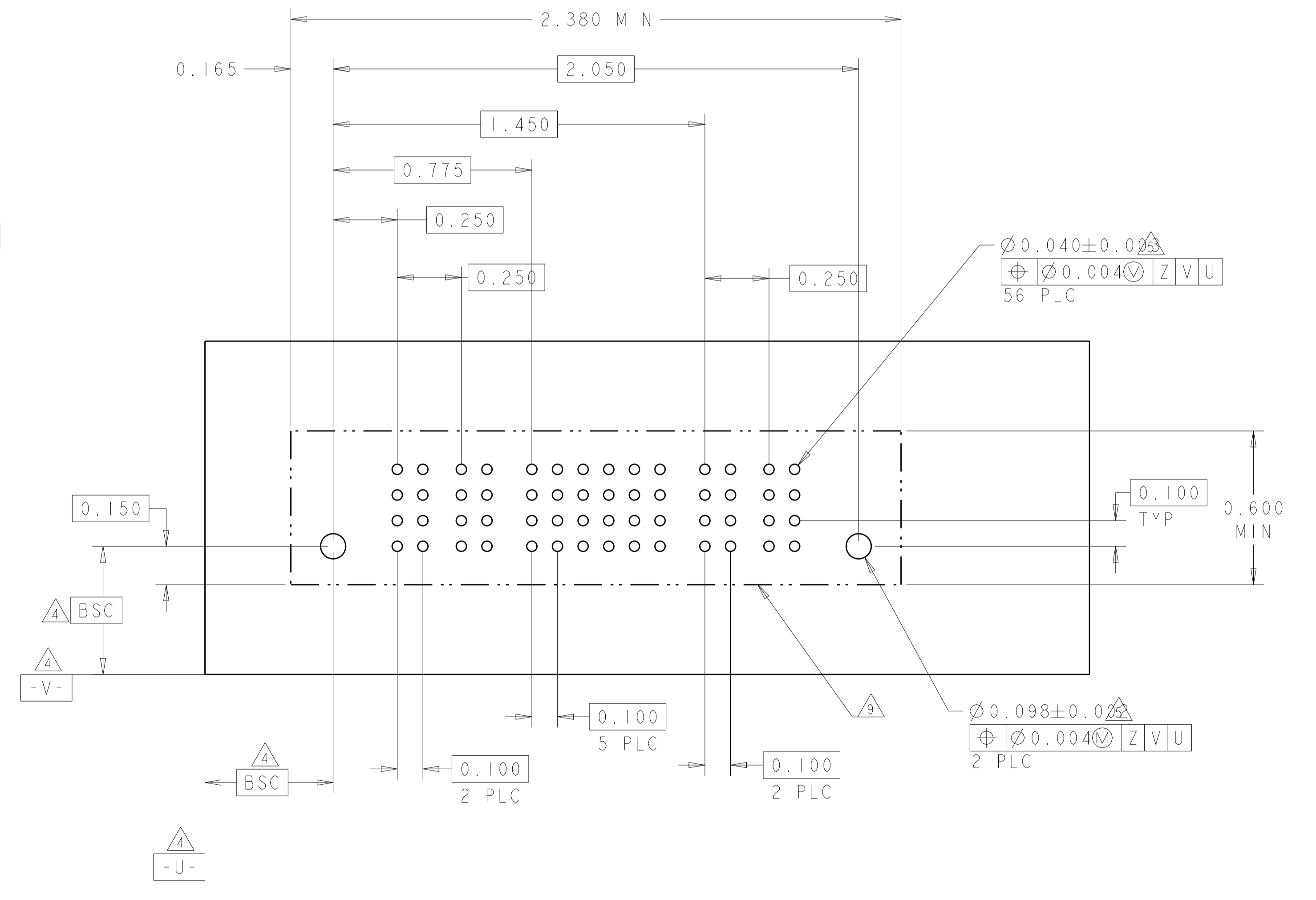
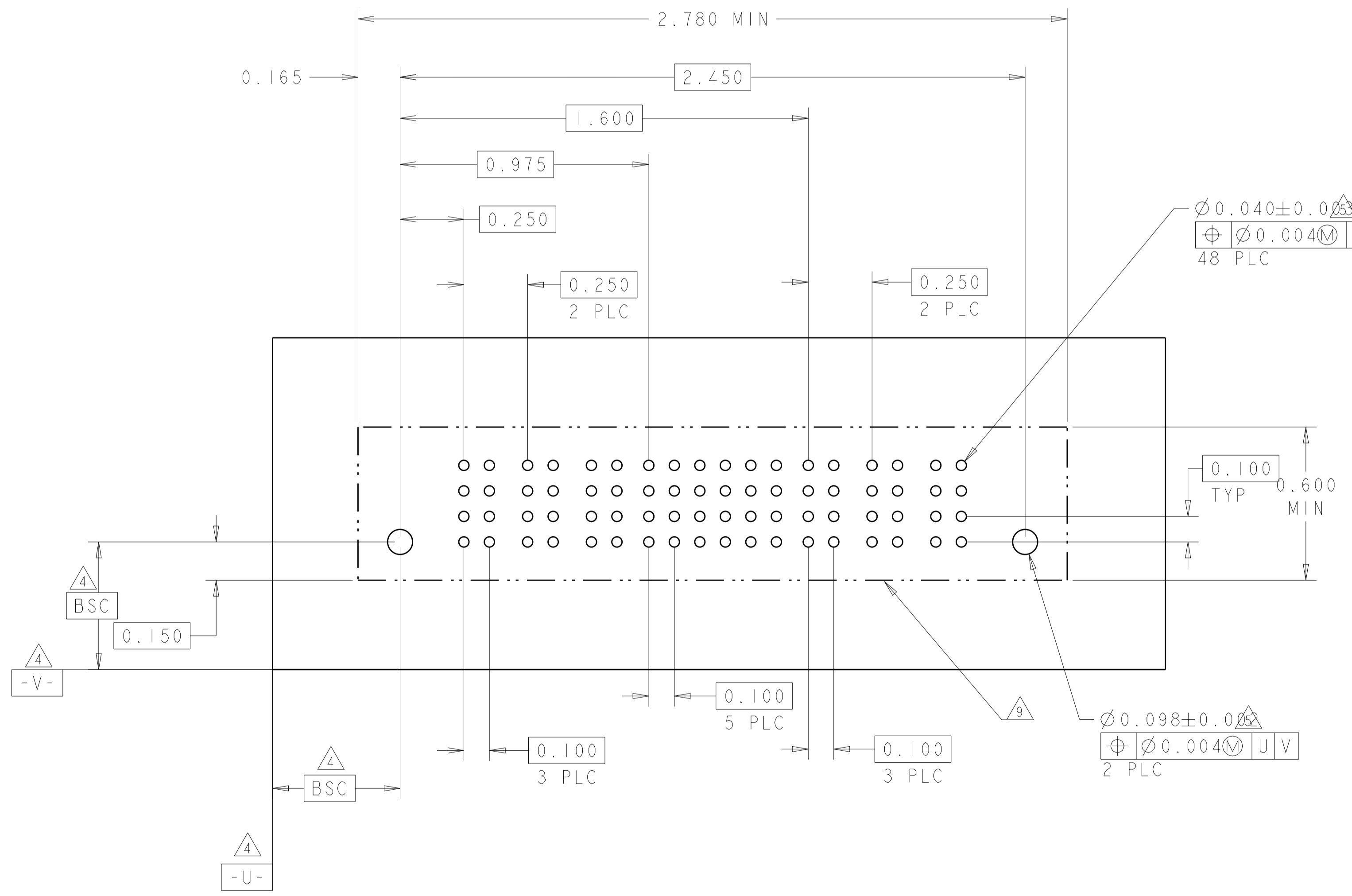

THIS DRAWING IS A CONTROLLED DOCUMENT.

DIMENSIONS:	TOLERANCES UNLESS OTHERWISE SPECIFIED:	OWN	23MAR2005
INCH	0 PLC ±	CHK	J. McCLINTON
	1 PLC ±.01	APPD	D. TROUT
	2 PLC ±.05	NAME	B. WHYNE
	3 PLC ±.0020	PRODUCT SPEC	23MAR2005
	ANGLES ±.020	APPLICATION SPEC	
MATERIAL	FINISH	SIZE	114-13038
		WEIGHT	
		RESTRICTED TO	

Customer Drawing

SCALE 3:1 SHEET 13 OF 22 REV P7

TE Connectivity

VERTICAL HEADER ASSEMBLY, W/GUIDES, PRESS FIT, TYPE PSP MULTI-BEAM XL

A100779C=6600333

LOC	DIST	REVISIONS			
P	LTN	DESCRIPTION	DATE	DMN	APVD
ES	00	SEE SHEET 1	-	-	-

PART NUMBER	ROWS	POWER				SIGNAL														POWER					
		P1	P2	P3	P4	1	2	3	4	5	6	7	8	9	10	11	12	13	14	P5	P6	P7	P8		
3-6600333-6	D	VM	VM	VM	VM	EV	EV	EV	EV	EV	EV	EV	EV	EV	EV	EV	EV	EV	EV	EV	EV	VM	VM	VM	VM
	C					EV	EV	EV	EV	EV	EV	EV	EV	EV	EV	EV	EV	EV	EV	EV	EV				
	B					EV	EV	EV	EV	EV	EV	EV	EV	EV	EV	EV	EV	EV	EV	EV	EV				
	A					EV	EV	EV	EV	EV	EV	EV	EV	EV	EV	EV	EV	EV	EV	EV	EV				
4P+56S+4P																									

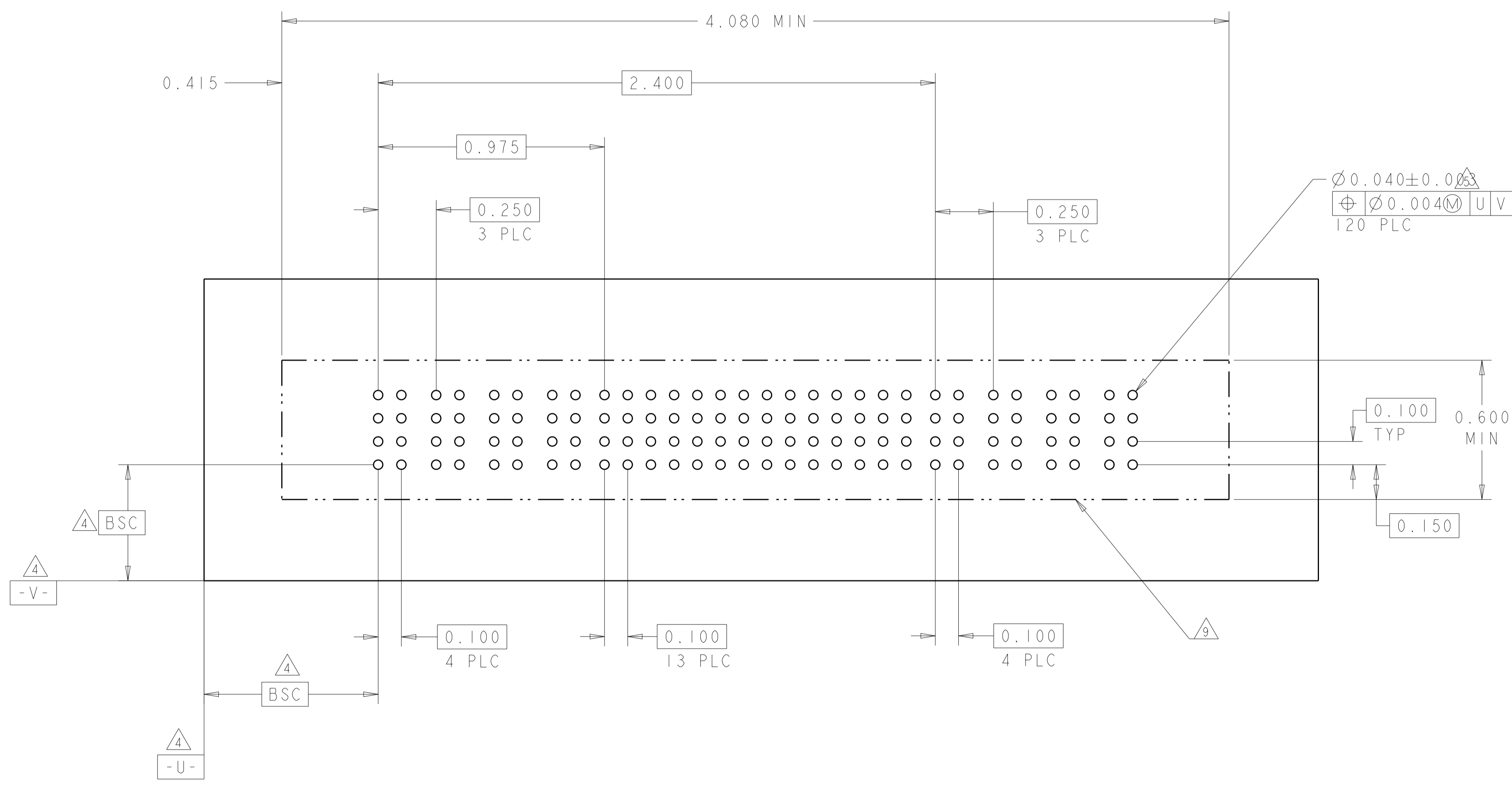

THIS DRAWING IS A CONTROLLED DOCUMENT.

DMN: J. McCLINTON 23MAR2005	TE Connectivity
CHK: D. TROUT 23MAR2005	
APVD: B. WHYNE 23MAR2005	NAME: VERTICAL HEADER ASSEMBLY, W/GUIDES, PRESS FIT, TYPE PSP MULTI-BEAM XL
DIMENSIONS: INCH	PRODUCT SPEC: 108-1973
TOLERANCES UNLESS OTHERWISE SPECIFIED:	APPLICATION SPEC: 114-13038
0 PLC ±	SIZE: A100779 C=6600333
1 PLC ±.01	RESTRICTED TO: -
2 PLC ±.01	SCALE: 3:1 SHEET 14 OF 22 REV P7
3 PLC ±.005	
4 PLC ±.0020	
ANGLES ±.2°	
MATERIAL: -	Customer Drawing
FINISH: -	

LOC	DIST	REV	DATE	BY	APPV
ES	00				

REVISIONS					
REV	DATE	BY	APPV	DESCRIPTION	DATE
-	-	-	-	SEE SHEET 1	-

PART NUMBER	ROWS	POWER						SIGNAL		POWER					
		P1	P2	P3	P4	P5	P6	I	2	P7	P8	P9	P10	P11	P12
3-6600333-8	D	VM	VM	VM	VM	VM	VM	EV	EV	VM	VM	VM	VM	VM	VM
	C							EV	EV						
	B							EV	EV						
	A							EV	EV						
6P+8S+6P		HD													HD

PART NUMBER	ROWS	POWER			SIGNAL						POWER		
		P1	P2	P3	1	2	3	4	5	6	P4	P5	P6
3-6600333-9	D	VM	VM	VM	EV	EV	EV	EV	EV	EV	VM	VM	VM
	C				EV	EV	EV	EV	EV				
	B				EV	EV	EV	EV	EV				
	A				ES	EV	EV	EV	EV				
3ACP+24S+3ACP		HD											HD

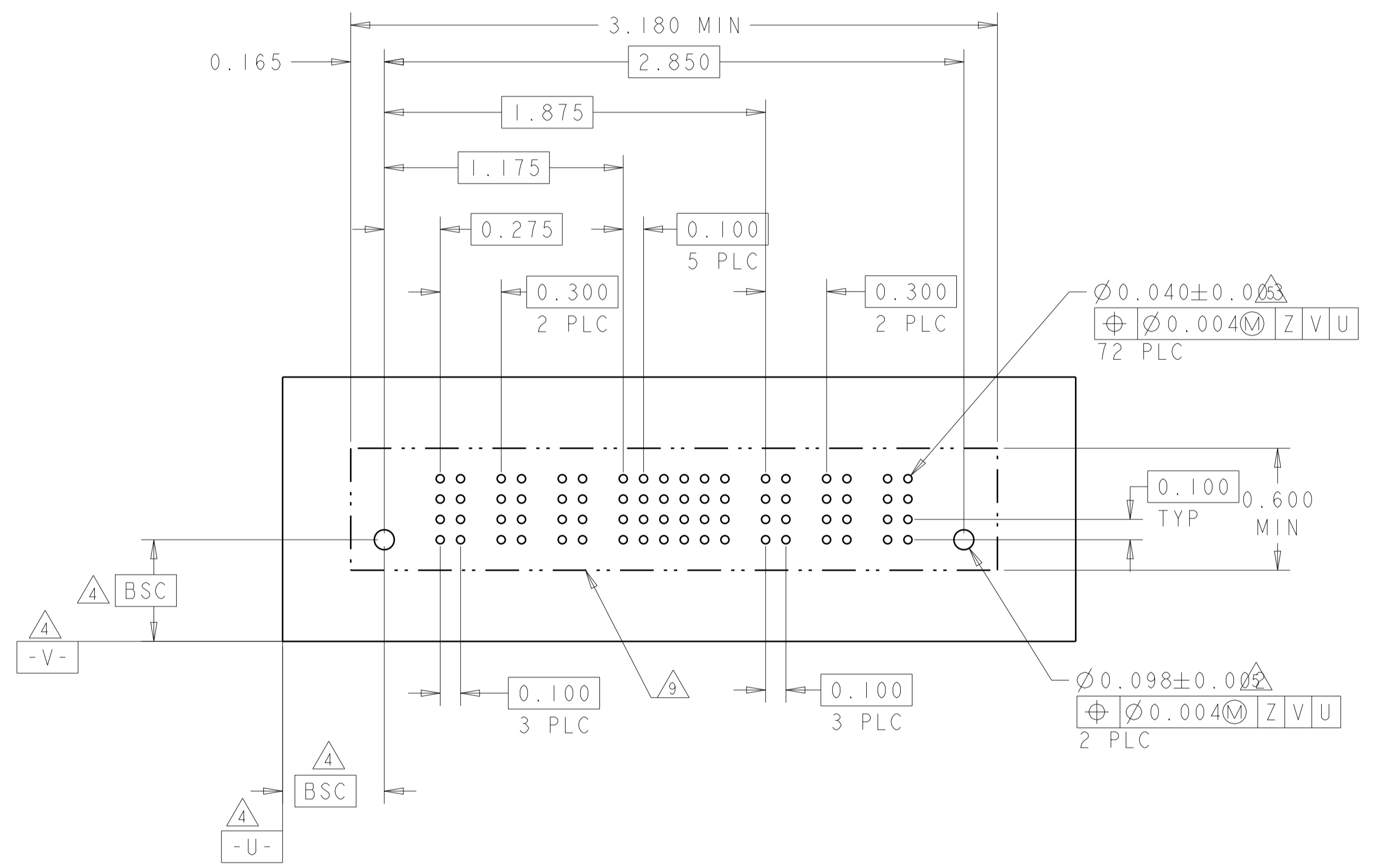
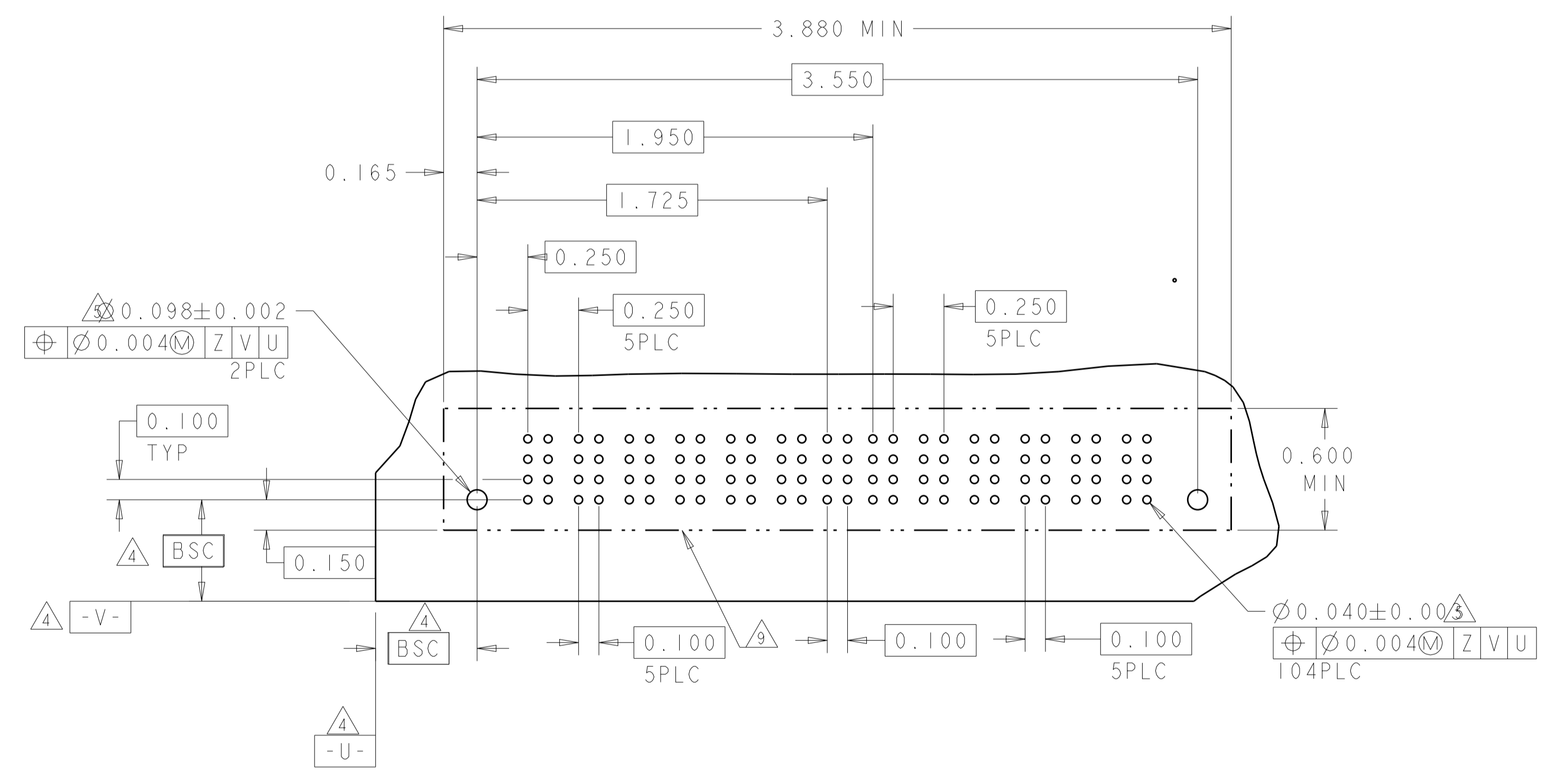

THIS DRAWING IS A CONTROLLED DOCUMENT.

DIMENSIONS:	TOLERANCES UNLESS OTHERWISE SPECIFIED:	OWN	J. McCLINTON	23MAR2005
INCH	0 PLC ±.01	CHK	D. TROUT	23MAR2005
	1 PLC ±.01	APPV	P. WHYNE	23MAR2005
	2 PLC ±.01	PRODUCT SPEC		
	3 PLC ±.005	APPLICATION SPEC		
	4 PLC ±.0020	SIZE	114-13038	
	ANGLES ±.020	WEIGHT		
MATERIAL	FINISH	Customer Drawing		

NAME: VERTICAL HEADER ASSEMBLY, W/GUIDES, PRESS FIT, TYPE PSP MULTI-BEAM XL

SIZE: A1 00779 C=6600333

SCALE: 3:1 SHEET 15 OF 22 REV P7



LOC		DIST		REVISIONS			
P	LTN	DESCRIPTION	DATE	DMN	APVD		
-	-	SEE SHEET 1	-	-	-		

PART NUMBER	ROWS	POWER		SIGNAL			POWER	
		P1	P2	1	2	3	P3	P4
4-6600330-1	D	VM	VM	EV	EV	EV	VM	VM
	C			EV	EV	EV		
	B			EV	EV	EV		
	A			EV	EV	EV		
2P + 12S + 2P								

PART NUMBER	ROWS	POWER		SIGNAL			POWER	
		P1	P2	1	2	3	P3	P4
4-6600333-9	D	VM	VM	ES	EV	EV	VM	VM
	C			EV	EV	EV		
	B			EV	EV	EV		
	A			EV	EV	EV		
IP+12S+IP								

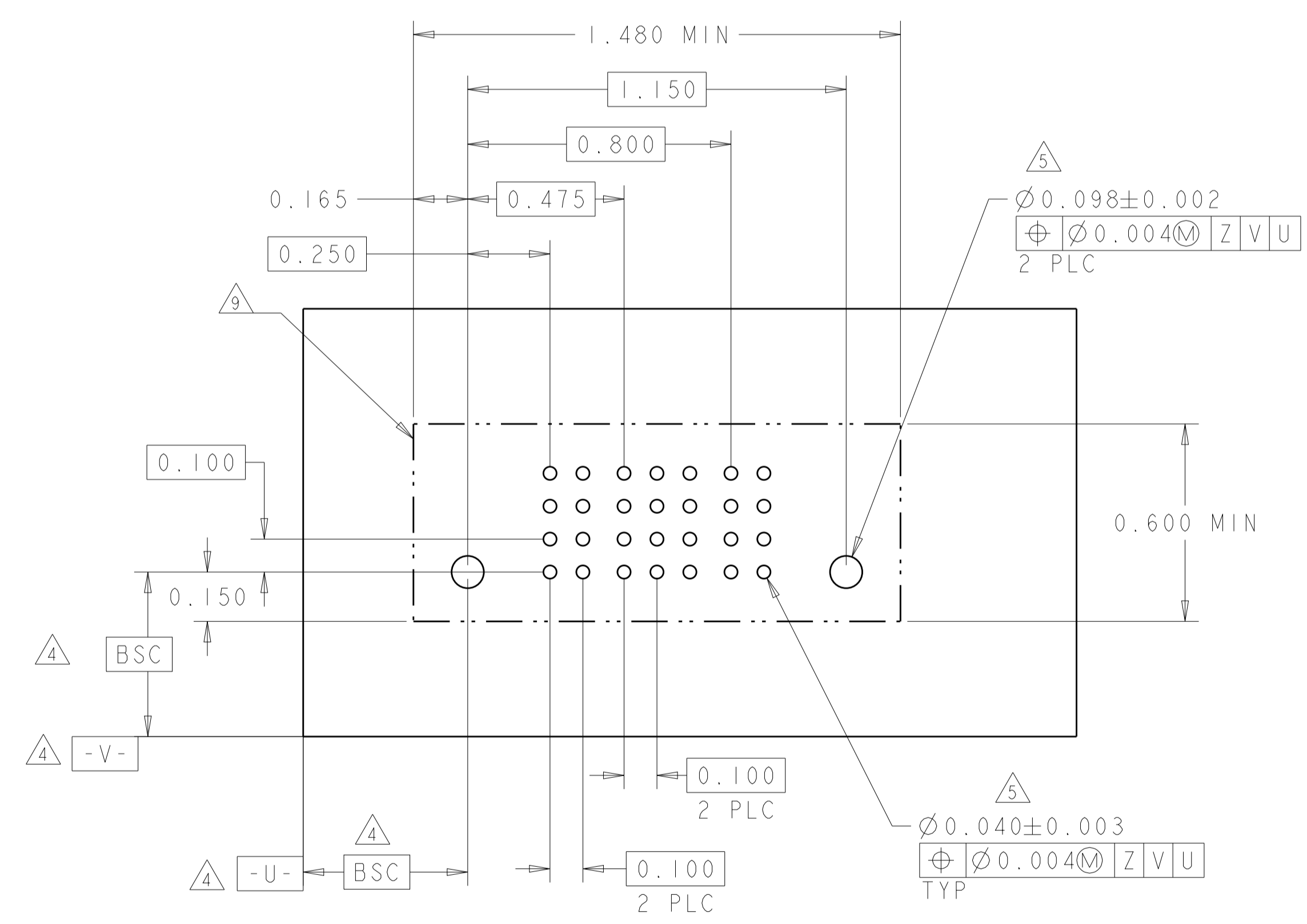
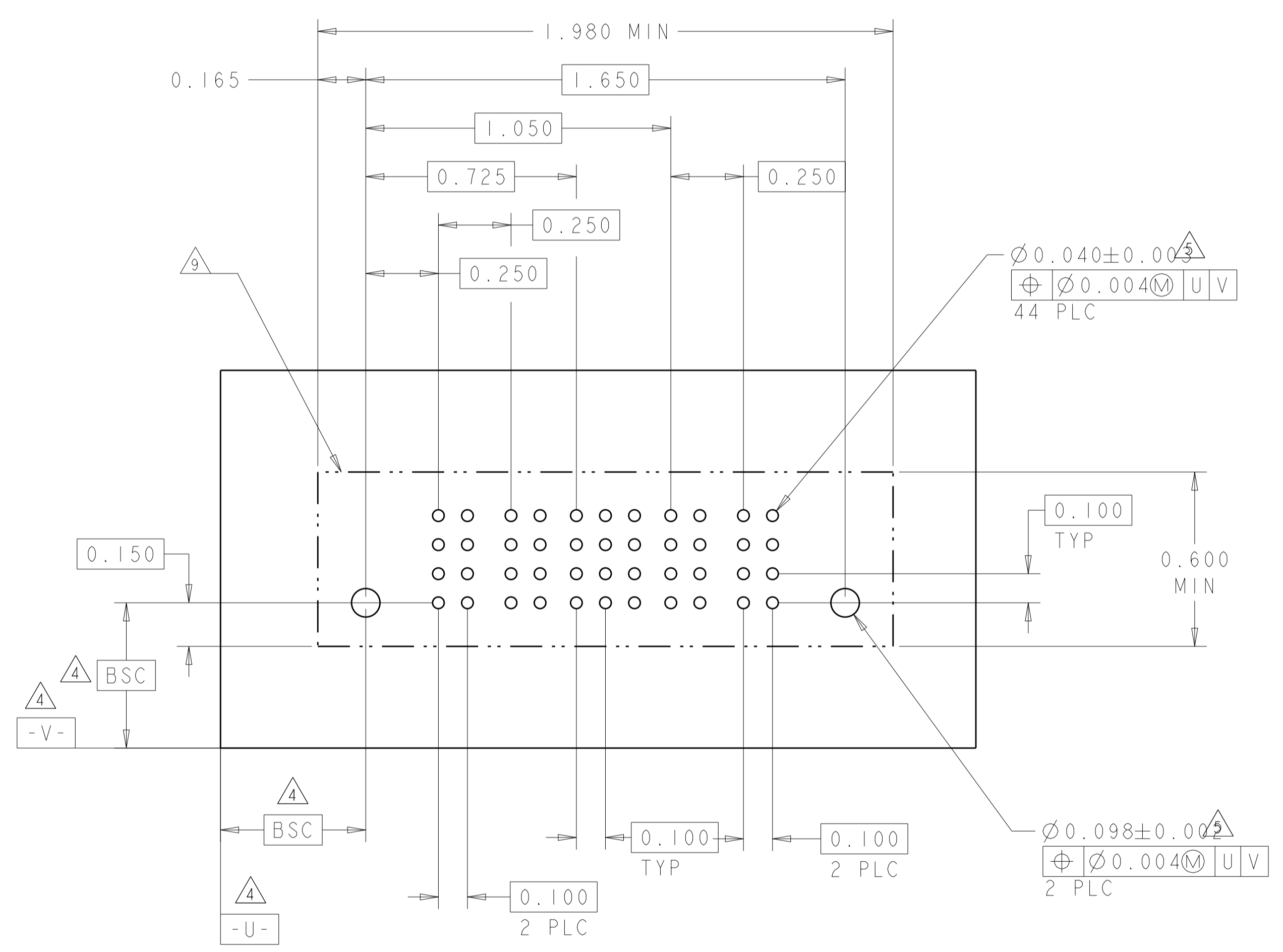

THIS DRAWING IS A CONTROLLED DOCUMENT.

DIMENSIONS: INCH	TOLERANCES UNLESS OTHERWISE SPECIFIED: 0 PLC ±. 1 PLC ±.01 2 PLC ±.005 3 PLC ±.002 4 PLC ±.002 ANGLES ±.7°	FINISH	DMN J. McCLINTON 23MAR2005	CHK D. TROUT 23MAR2005	APVD B. MHYNE 23MAR2005	NAME VERTICAL HEADER ASSEMBLY, W/GUIDES, PRESS FIT, TYPE PSP MULTI-BEAM XL
MATERIAL			PRODUCT SPEC 108-1973	APPLICATION SPEC 114-13038	WEIGHT	SIZE A100779
			Customer Drawing	SCALE 3:1	SHEET 16	OF 22

RESTRICTED TO  
REV P7

LOC	DIST	REVISIONS			
P	LTN	DESCRIPTION	DATE	DMN	APVD
ES	00	SEE SHEET 1	-	-	-

PART NUMBER	ROWS	POWER								SIGNAL				POWER								HD				
		P1	P2	P3	P4	P5	P6	P7	P8	1	2	3	4	P9	P10	P11	P12	P13	P14	P15	P16					
4-6600333-2	D	⌋	VM	VM	VM	VM	VM	VM	VM	VM	VM	EV	EV	EV	EV	VM	VM	VM	VM	VM	VM	VM	VM	VM	⌋	
	EV											EV	EV	EV												
	EV											EV	EV	EV												
	EV											EV	EV	EV												
8P+16S+8P	HD																									HD

(N)

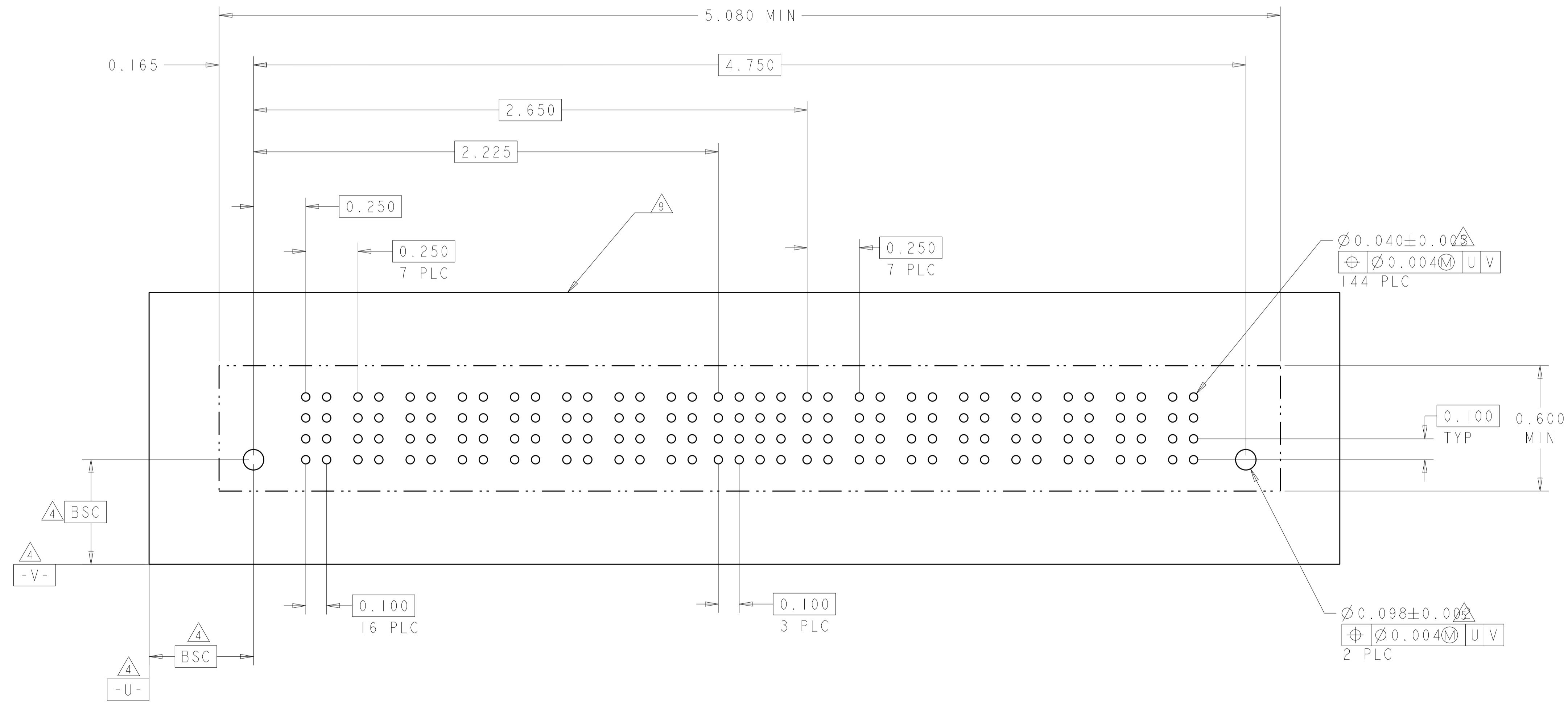

THIS DRAWING IS A CONTROLLED DOCUMENT.		DMN J. McCLINTON 23MAR2005	 TE Connectivity
DIMENSIONS: INCH		CHK D. TROUT 23MAR2005	
TOLERANCES UNLESS OTHERWISE SPECIFIED: 0 PLC ±. 1 PLC ±.01 2 PLC ±.005 3 PLC ±.002 4 PLC ±.0020 ANGLES ±.5°		APVD B. WHYNE 23MAR2005	NAME VERTICAL HEADER ASSEMBLY, W/GUIDES, PRESS FIT, TYPE PSP MULTI-BEAM XL
MATERIAL	FINISH	PRODUCT SPEC 108-1973	SIZE A100779C=6600333
Customer Drawing		APPLICATION SPEC 114-13038	RESTRICTED TO -
		WEIGHT	SCALE 3:1
		Customer Drawing	SHEET 17 OF 22
			REV P7

LOC	DIST	REVISIONS			
P	LTN	DESCRIPTION	DATE	DMN	APVD
ES	00	SEE SHEET 1			

(N2)

PART NUMBER	ROWS	POWER		SIGNAL						POWER	
		P1	P2	1	2	3	4	5	6	P3	P4
4-6600333-4	D	VM	VM	EV	EV	EV	EV	EV	EV	VM	VM
	C			EV	EV	EV	EV	EV			
	B			EV	EV	EV	EV	EV			
	A			ES	ES	ES	ES	ES			
2P+24S+2P											

(N3)

PART NUMBER	ROWS	POWER				SIGNAL			POWER			
		P1	P2	P3	P4	1	2	3	P5	P6	P7	P8
4-6600333-6	D	VM	VM	VM	VM	EV	EV	EV	VM	VM	VM	VM
	C					EV	EV	EV				
	B					EV	EV	EV				
	A					EV	EV	EV				
4P + 12S + 4P												

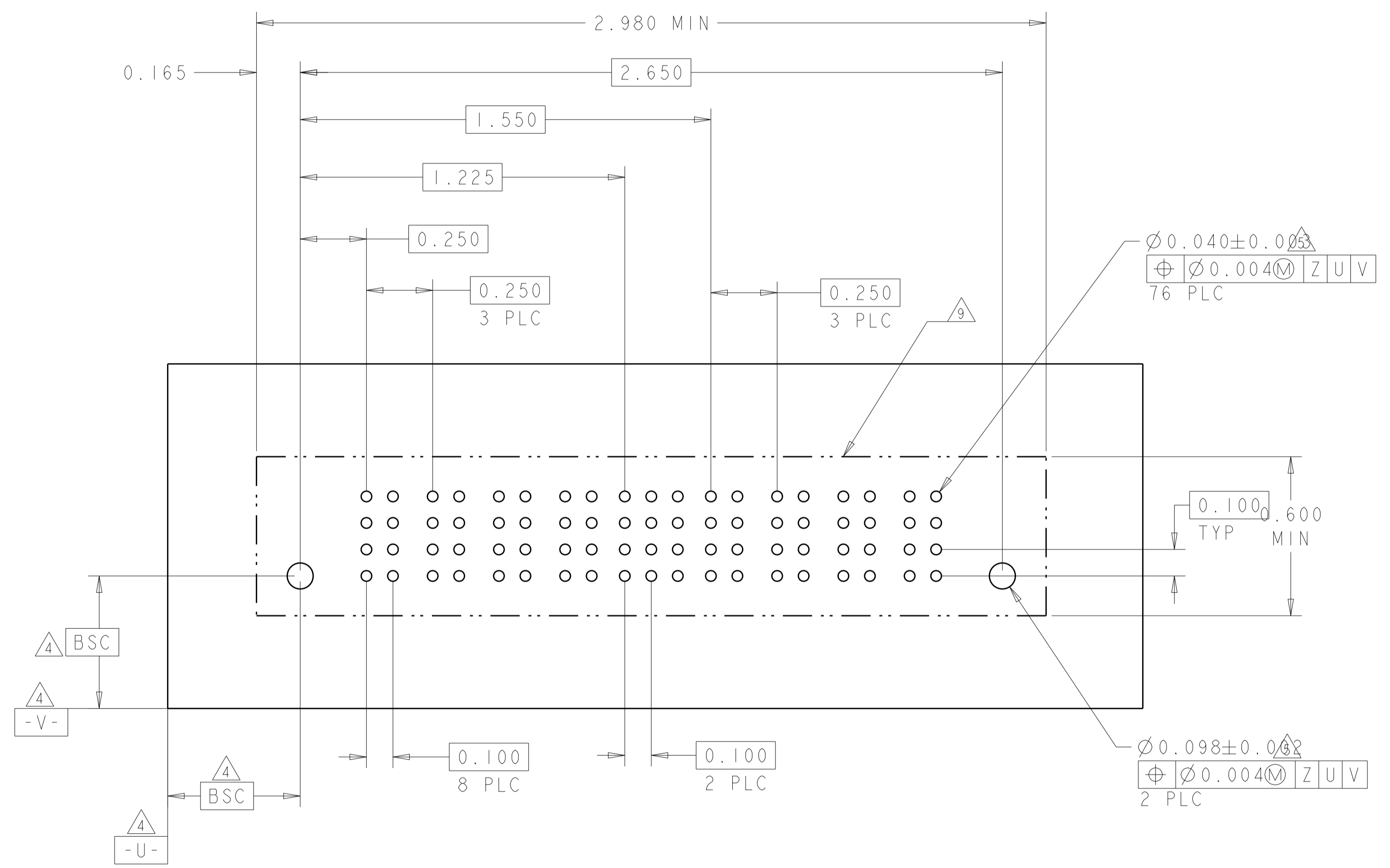
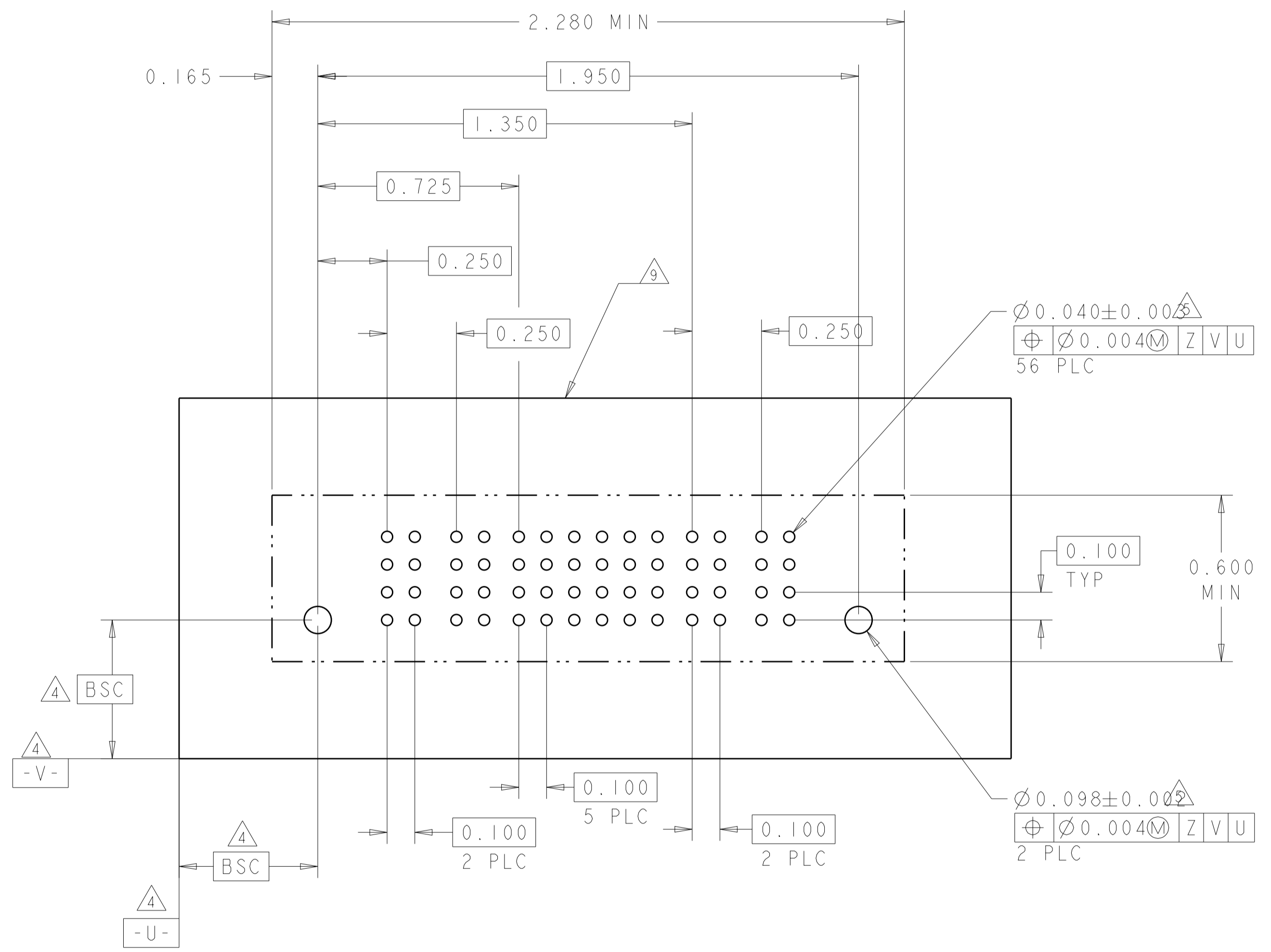

THIS DRAWING IS A CONTROLLED DOCUMENT.

DIMENSIONS: INCH	TOLERANCES UNLESS OTHERWISE SPECIFIED: 0 PLC ±. 1 PLC ±.01 2 PLC ±.01 3 PLC ±.005 4 PLC ±.0020 ANGLES ±.7°	DMN: J. McCLINTON 23MAR2005 CHK: D. TROUT 23MAR2005 APVD: P. WYNE 23MAR2005	NAME: VERTICAL HEADER ASSEMBLY, W/GUIDES, PRESS FIT, TYPE PSP MULTI-BEAM XL PRODUCT SPEC: 108-1973 APPLICATION SPEC: 114-13038 WEIGHT: - SCALE: 3:1	RESTRICTED TO: - SHEET 18 OF 22 REV P7
---------------------	--	---	---	--

Customer Drawing

LOC	DIST	REV	DATE	BY	APPV
ES	00				
SEE SHEET 1					

PART NUMBER	ROWS	POWER		SIGNAL						POWER	
		P1	P2	1	2	3	4	5	6	P3	P4
4-6600333-3	D	VM	VM	ES	EV	EV	EV	EV	EV	VM	VM
	C			EV	EV	EV	EV	EV			
	B			EV	EV	EV	EV	EV			
	A			EV	EV	EV	EV	EV			
2ACP+24S+2ACP	HD										

PART NUMBER	ROWS	POWER		SIGNAL						POWER	
		P1	P2	1	2	3	4	5	6	P3	P4
4-6600333-5	D	VM	VM	EV	EV	EV	EV	EV	EV	VM	VM
	C			EV	EV	EV	EV	EV			
	B			EV	EV	ES	EV	EV			
	A			ES	EV	EV	EV	EV			
2ACP+24S+2ACP	HD										

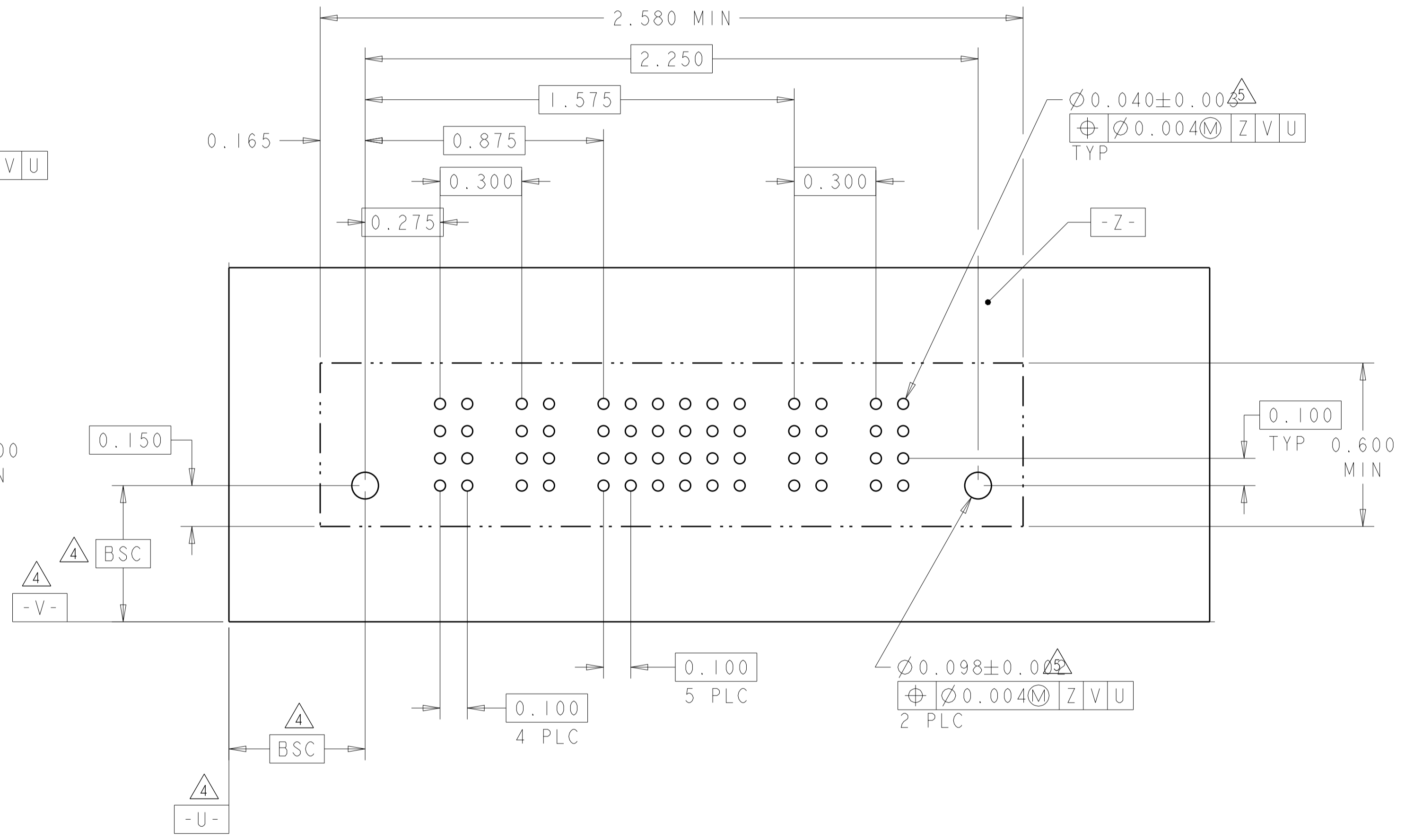
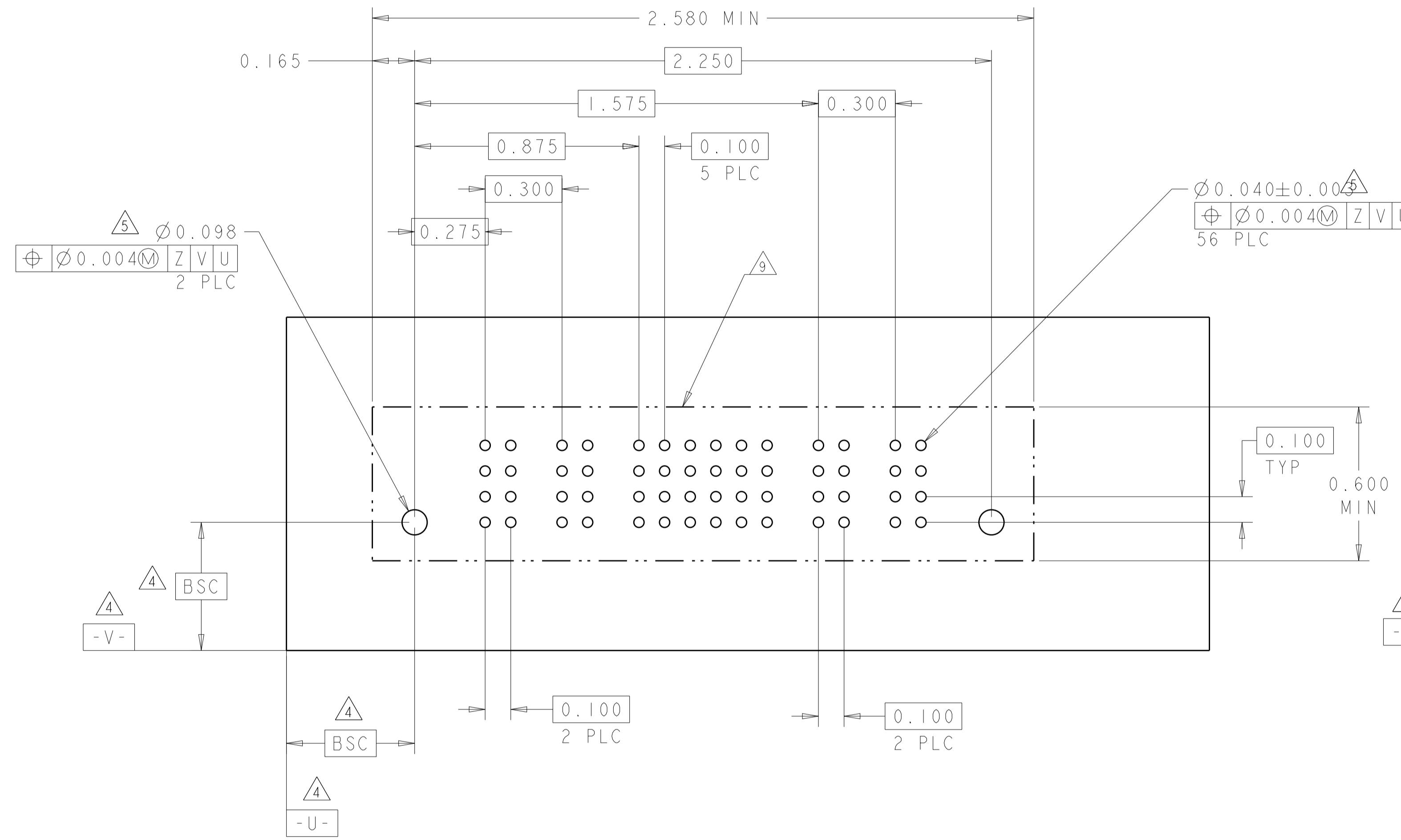

THIS DRAWING IS A CONTROLLED DOCUMENT.

DIMENSIONS:	TOLERANCES UNLESS OTHERWISE SPECIFIED:	OWN	J. McCLINTON	23MAR2005
INCH	0 PLC ±.01	CHK	D. TROUT	23MAR2005
	1 PLC ±.01	APPV	B. WHYNE	23MAR2005
	2 PLC ±.01	PRODUCT SPEC		
	3 PLC ±.005	APPLICATION SPEC		
	4 PLC ±.0020	SIZE	114-13038	
	ANGLES ±.2°	WEIGHT		
MATERIAL	FINISH	Customer Drawing		

NAME: VERTICAL HEADER ASSEMBLY, W/GUIDES, PRESS FIT, TYPE PSP MULTI-BEAM XL

SIZE: A1 00779 C=6600333

SCALE: 3:1 SHEET 19 OF 22 REV P7

LOC	DIST	REVISIONS					
		P	LTN	DESCRIPTION	DATE	DMN	APVD
ES	00	-	-	SEE SHEET 1	-	-	-

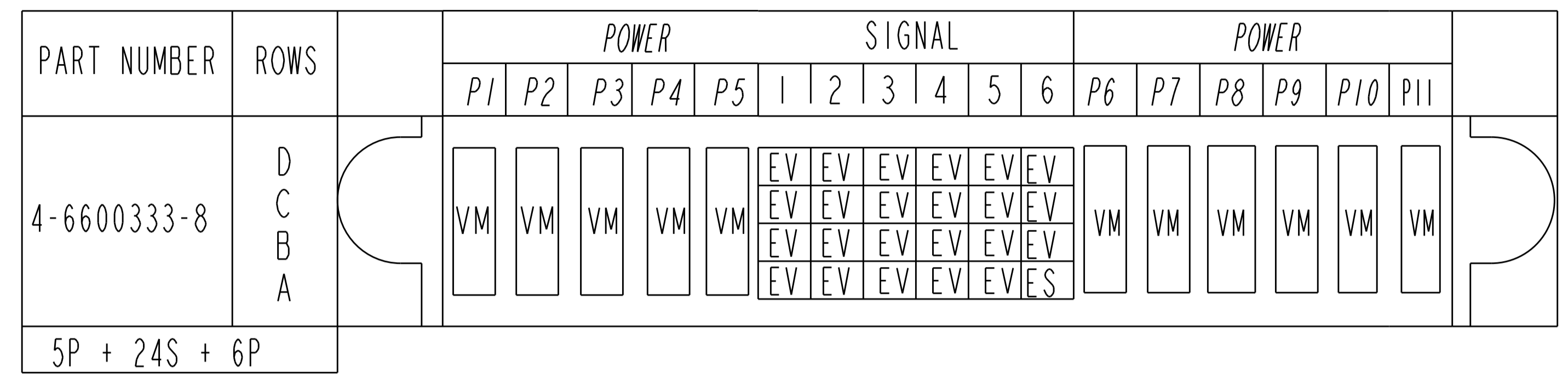

(N7)

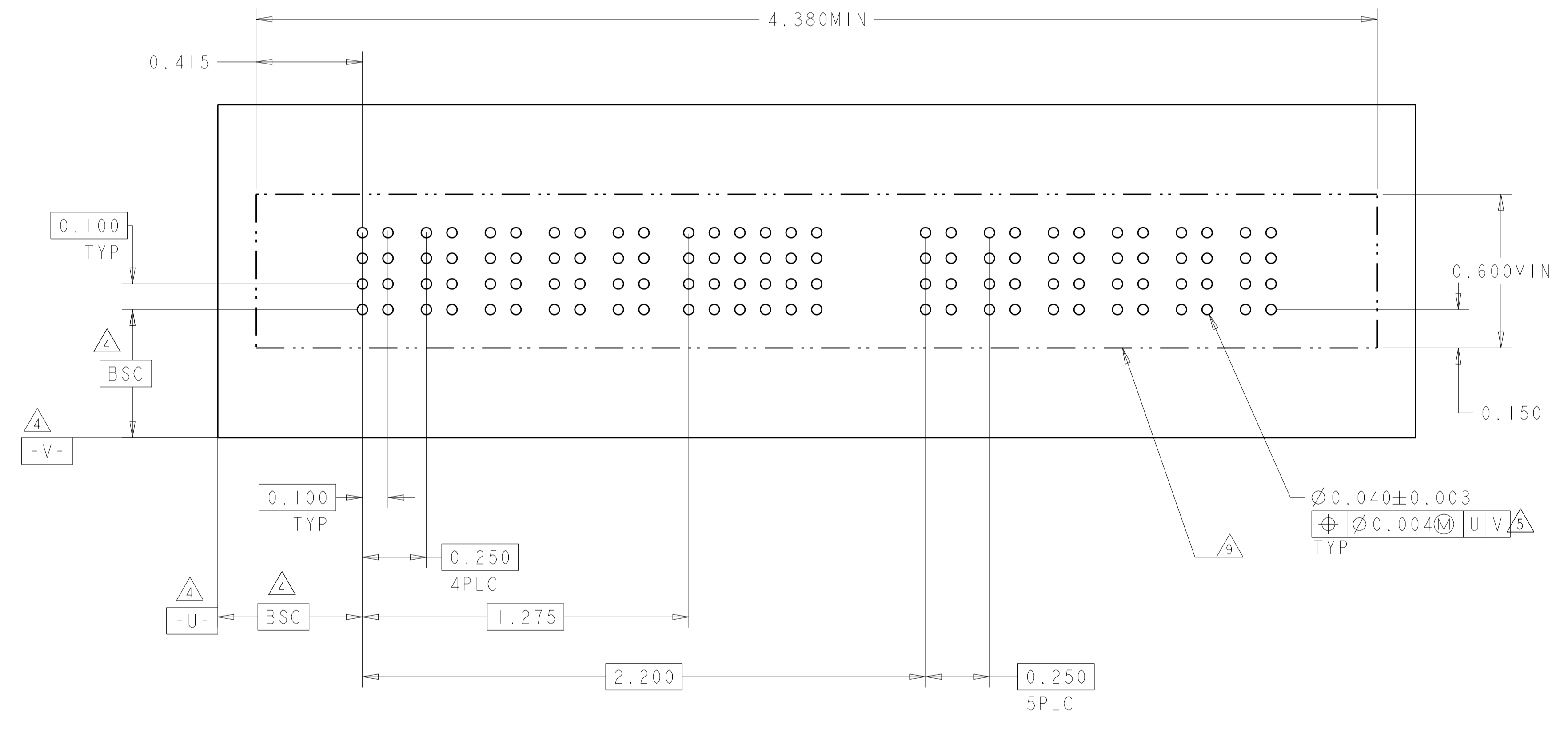

(N6)

RECOMMENDED PCB LAYOUT 4-6600333-8

THIS DRAWING IS A CONTROLLED DOCUMENT.		DMN J. McCLINTON 23MAR2005	 TE Connectivity												
DIMENSIONS: INCH		CHK D. TROUT 23MAR2005													
TOLERANCES UNLESS OTHERWISE SPECIFIED:		APVD B. WHYNE 23MAR2005	NAME VERTICAL HEADER ASSEMBLY, W/GUIDES, PRESS FIT, TYPE PSP MULTI-BEAM XL												
<table border="1"> <tr> <td>0 PLC</td> <td>±</td> </tr> <tr> <td>1 PLC</td> <td>±.01</td> </tr> <tr> <td>2 PLC</td> <td>±.01</td> </tr> <tr> <td>3 PLC</td> <td>±.005</td> </tr> <tr> <td>4 PLC</td> <td>±.0020</td> </tr> <tr> <td>ANGLES</td> <td>±2°</td> </tr> </table>		0 PLC	±	1 PLC	±.01	2 PLC	±.01	3 PLC	±.005	4 PLC	±.0020	ANGLES	±2°	PRODUCT SPEC 108-1973	SIZE A100779
0 PLC	±														
1 PLC	±.01														
2 PLC	±.01														
3 PLC	±.005														
4 PLC	±.0020														
ANGLES	±2°														
MATERIAL		APPLICATION SPEC 114-13038	CAGE CODE C=6600333												
FINISH		WEIGHT	RESTRICTED TO												
		Customer Drawing	SCALE 3:1 SHEET 20 OF 22 REV P7												

LOC	DIST	REVISIONS					
ES	00	P	LTN	DESCRIPTION	DATE	DMN	APVD
-	-	-	-	SEE SHEET 1	-	-	-

PART NUMBER	ROWS	POWER		SIGNAL						POWER				
		P1	P2	1	2	3	4	5	6	P3	P4	P5	P6	
5-6600333-0	D C B A	VM	VM	EV	EV	EV	EV	EV	EV	VM	VM	VM	VM	
				EV	EV	EV	EV	EV	EV					
				EV	EV	EV	EV	EV	EV					
				EV	EV	EV	EV	EV	EV					
2P + 24S + 4P														

PART NUMBER	ROWS	POWER						SIGNAL												POWER																								
		P1	P2	P3	P4	P5	P6	1	2	3	4	5	6	7	8	9	10	11	12	P7	P8	P9	P10	P11																				
5-6600333-1	D C B A	VM	VM	VM	VM	VM	VM	ES	ES	ES	ES	ES	ES	ES	ES	ES	ES	ES	ES	ES	ES	ES	ES	ES	ES	ES	ES	ES	ES	ES	VM	VM	VM	VM	VM									
								ES	ES	ES	ES	ES	ES	ES	ES	ES	ES	ES	ES	ES	ES	ES	ES	ES	ES	ES	ES	ES	ES	ES						ES	ES	ES	ES	ES	ES	ES	ES	
								ES	ES	ES	ES	ES	ES	ES	ES	ES	ES	ES	ES	ES	ES	ES	ES	ES	ES	ES	ES	ES	ES	ES						ES	ES	ES	ES	ES	ES	ES	ES	ES
								ES	ES	ES	ES	ES	ES	ES	ES	ES	ES	ES	ES	ES	ES	ES	ES	ES	ES	ES	ES	ES	ES	ES						ES	ES	ES	ES	ES	ES	ES	ES	ES
6P + 48S + 5P																																												

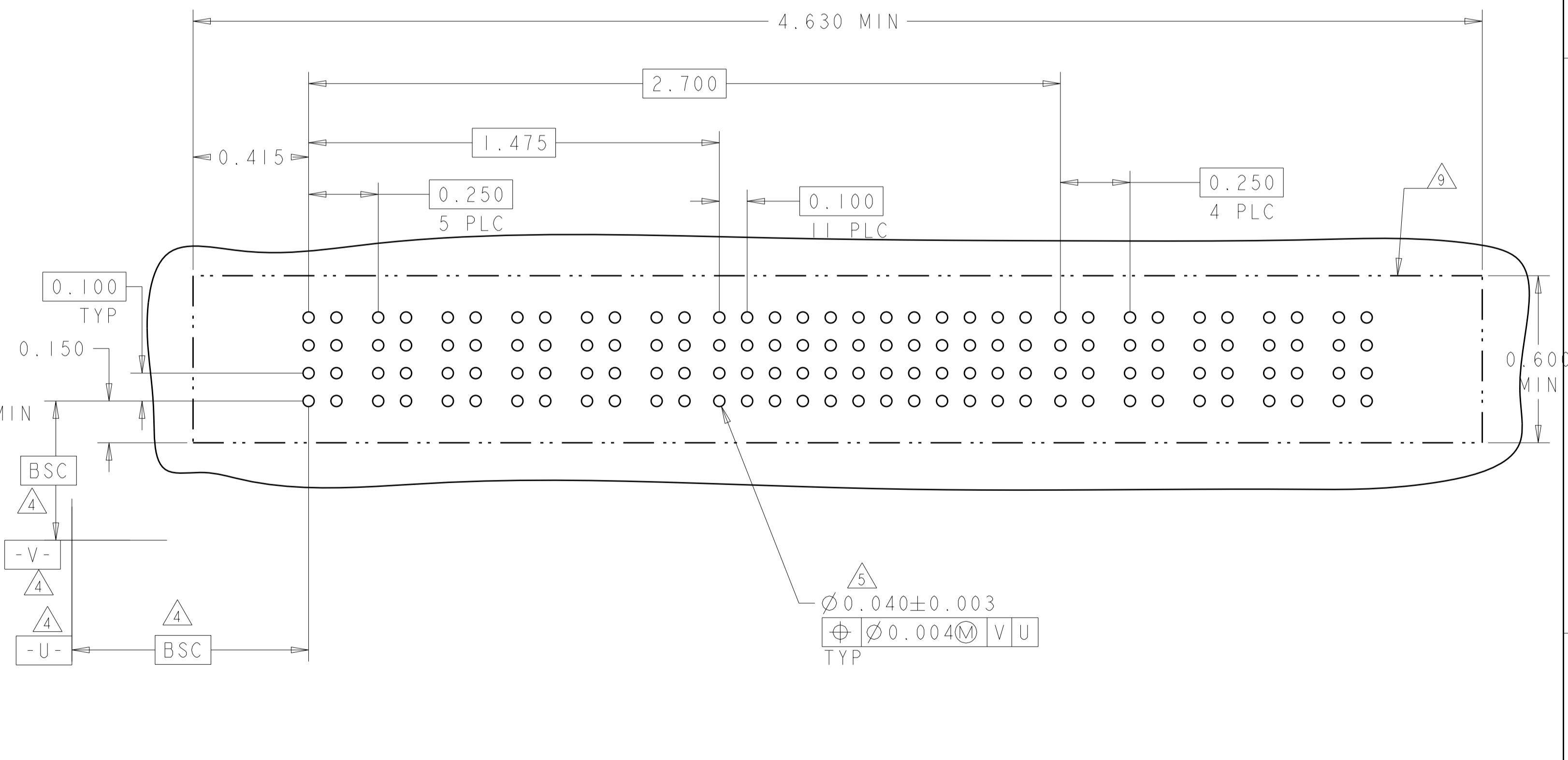
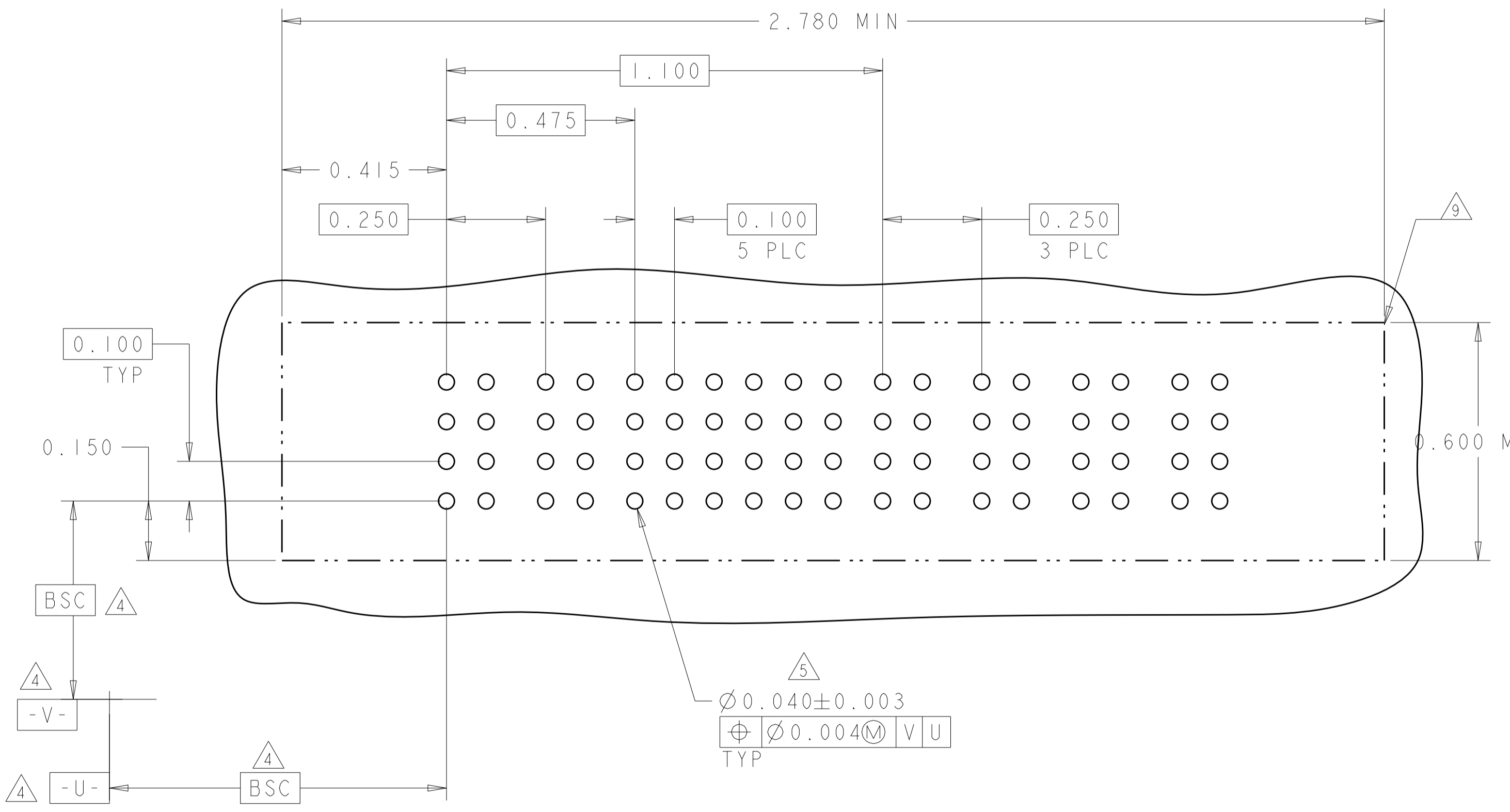

THIS DRAWING IS A CONTROLLED DOCUMENT.		DMN J. McCLINTON 23MAR2005	TE Connectivity														
DIMENSIONS: INCH		CHK D. TROUT 23MAR2005															
TOLERANCES UNLESS OTHERWISE SPECIFIED:		APVD B. WHYNE 23MAR2005	NAME VERTICAL HEADER ASSEMBLY, W/GUIDES, PRESS FIT, TYPE PSP MULTI-BEAM XL														
<table border="1"> <tr> <td>0 PLC</td><td>±</td></tr> <tr> <td>1 PLC</td><td>±.01</td></tr> <tr> <td>2 PLC</td><td>±.005</td></tr> <tr> <td>3 PLC</td><td>±.002</td></tr> <tr> <td>4 PLC</td><td>±.002</td></tr> <tr> <td>ANGLES</td><td>±.002</td></tr> <tr> <td>FINISH</td><td>±.002</td></tr> </table>		0 PLC	±	1 PLC	±.01	2 PLC	±.005	3 PLC	±.002	4 PLC	±.002	ANGLES	±.002	FINISH	±.002	PRODUCT SPEC 108-1973	SIZE A100779
0 PLC	±																
1 PLC	±.01																
2 PLC	±.005																
3 PLC	±.002																
4 PLC	±.002																
ANGLES	±.002																
FINISH	±.002																
MATERIAL		APPLICATION SPEC 114-13038	CAGE CODE DRAWING NO C=6600333														
WEIGHT		RESTRICTED TO	SCALE 3:1 SHEET 21 OF 22 REV P7														
Customer Drawing		Customer Drawing															

LOC		DIST		REVISIONS			
ES	00	P	LTH	DESCRIPTION	DATE	DWN	APVD
		-		SEE SHEET 1	-	-	-

PART NUMBER	ROWS	POWER		SIGNAL												POWER			
		P1	P2	1	2	3	4	5	6	7	8	9	10	11	12	P3	P4		
5-6600333-2	D	VM	VM	EV	EV	EV	EV	EV	EV	EV	EV	EV	EV	EV	EV	EV	EV	EV	
	C			EV	EV	EV	EV	EV	EV	EV	EV	EV	EV	EV	EV	EV	EV	EV	
	B			EV	EV	EV	EV	EV	EV	EV	EV	EV	EV	EV	EV	EV	EV	EV	EV
	A			ES	ES	ES	ES	ES	ES	EV	EV	EV	EV	EV	EV	EV	EV	EV	EV
2P+48S+2P																			

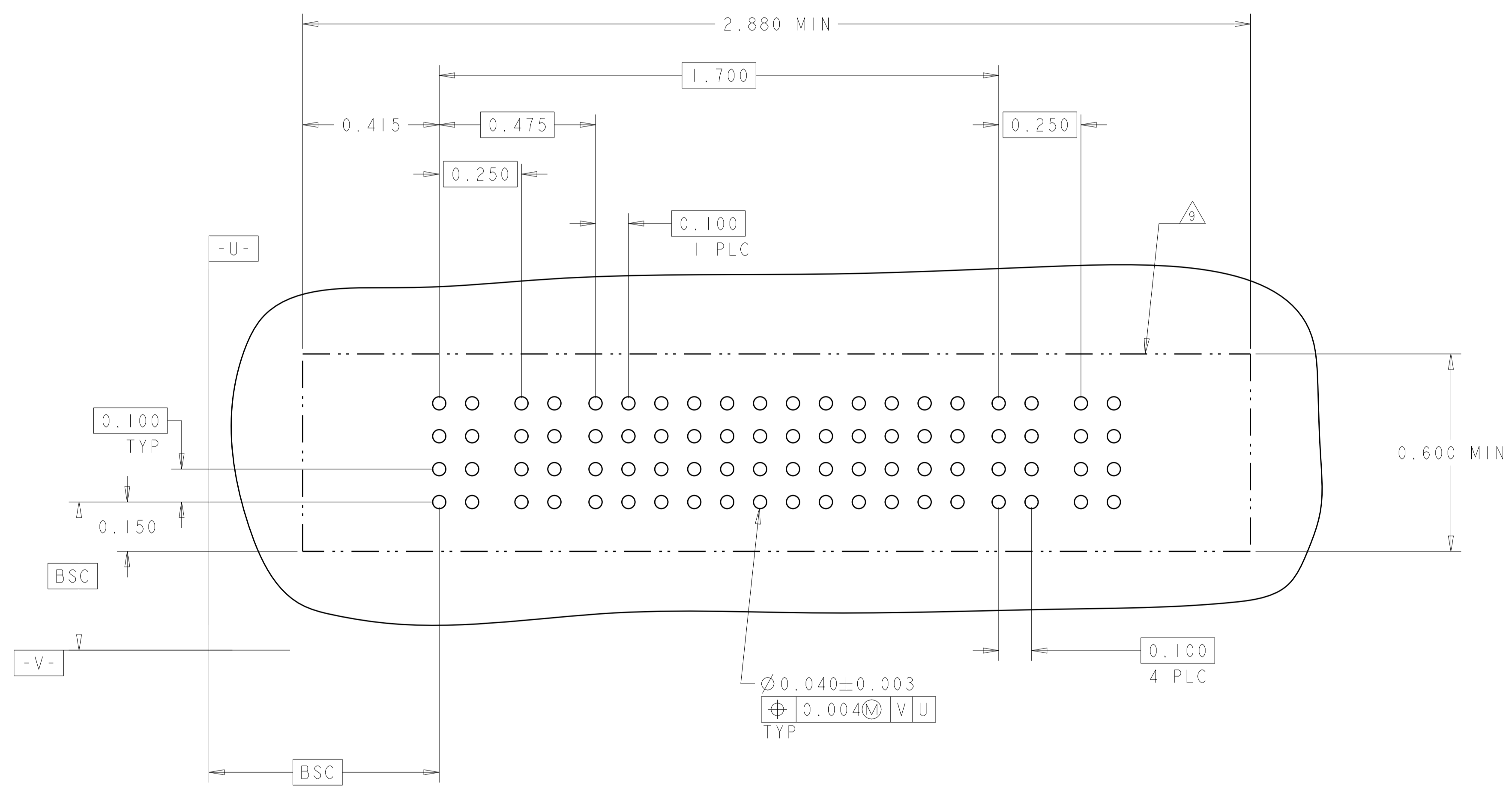

THIS DRAWING IS A CONTROLLED DOCUMENT.		DWN J. McCLINTON 23MAR2005	TE Connectivity <b>VERTICAL HEADER ASSEMBLY, W/GUIDES,                  PRESS FIT, TYPE PSP                  MULTI-BEAM XL</b>
DIMENSIONS: INCH		CHK D. TROUT 23MAR2005	
TOLERANCES UNLESS OTHERWISE SPECIFIED:		APVD B. WILBYNE 23MAR2005	NAME
0 PLC ±	1 PLC ±.01	PRODUCT SPEC	SIZE
2 PLC ±.01	3 PLC ±.005	APPLICATION SPEC	CAGE CODE
4 PLC ±.0020	ANGLES ±.2°	114-13038	DRAWING NO
MATERIAL	FINISH	WEIGHT	RESTRICTED TO
		Customer Drawing	A100779C=6600333
SCALE 3:1		SHEET 22	REV P7