



Chipsmall Limited consists of a professional team with an average of over 10 year of expertise in the distribution of electronic components. Based in Hongkong, we have already established firm and mutual-benefit business relationships with customers from,Europe,America and south Asia,supplying obsolete and hard-to-find components to meet their specific needs.

With the principle of “Quality Parts,Customers Priority,Honest Operation,and Considerate Service”,our business mainly focus on the distribution of electronic components. Line cards we deal with include Microchip,ALPS,ROHM,Xilinx,Pulse,ON,Everlight and Freescale. Main products comprise IC,Modules,Potentiometer,IC Socket,Relay,Connector.Our parts cover such applications as commercial,industrial, and automotives areas.

We are looking forward to setting up business relationship with you and hope to provide you with the best service and solution. Let us make a better world for our industry!



## Contact us

Tel: +86-755-8981 8866 Fax: +86-755-8427 6832

Email & Skype: info@chipsmall.com Web: www.chipsmall.com

Address: A1208, Overseas Decoration Building, #122 Zhenhua RD., Futian, Shenzhen, China



LOC	DIST	REVISIONS			
P	LTR	DESCRIPTION	DATE	DWN	APVD
CE	00	A	REV PER ECR-06-003731	16FEB2006	BB DK

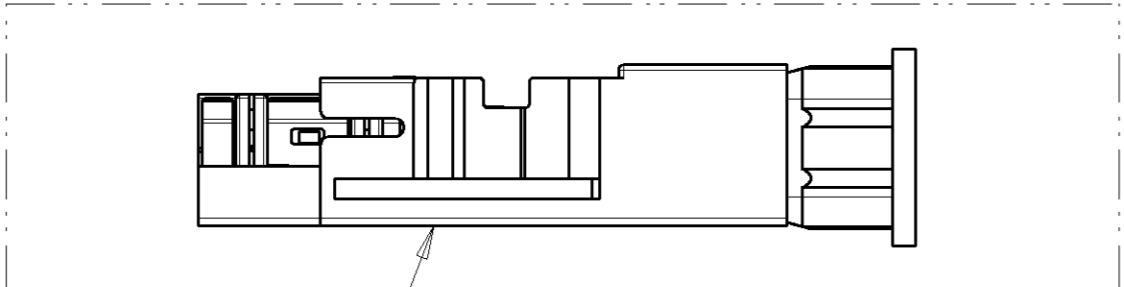
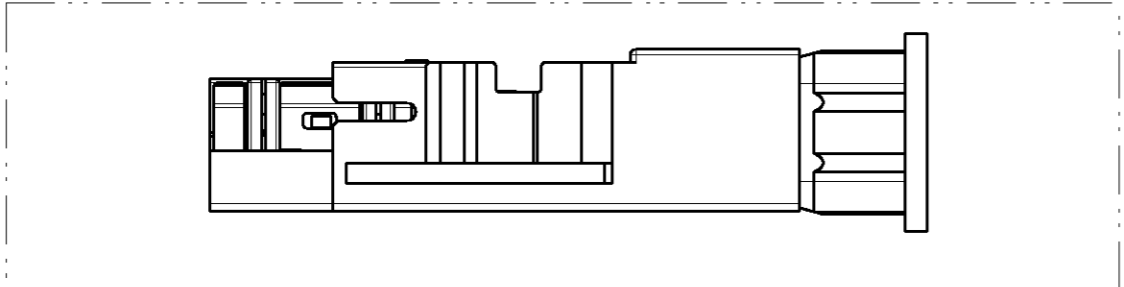
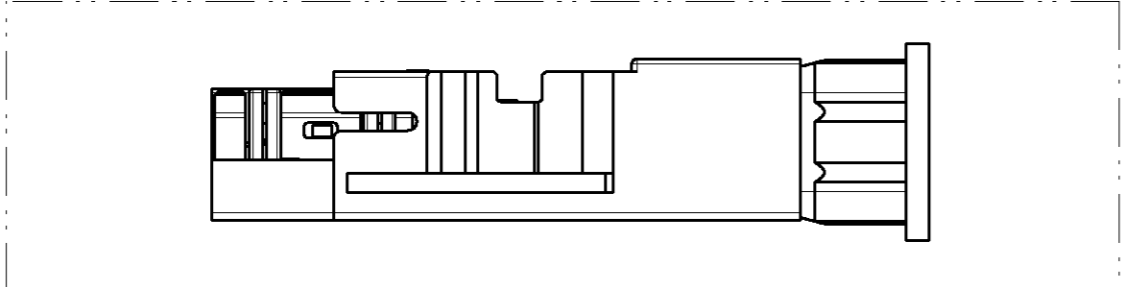
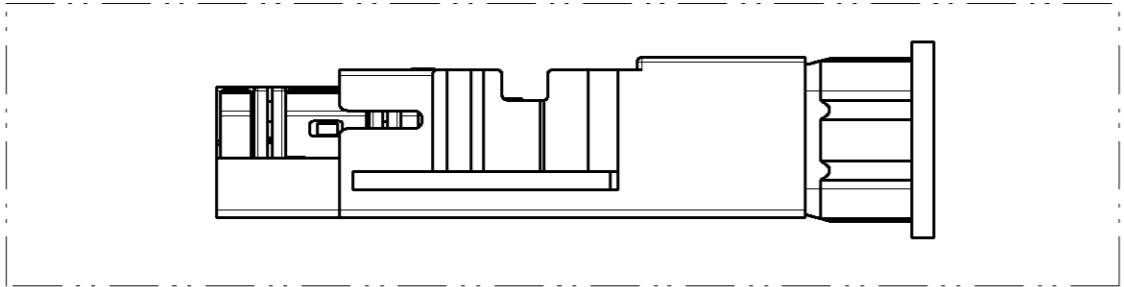
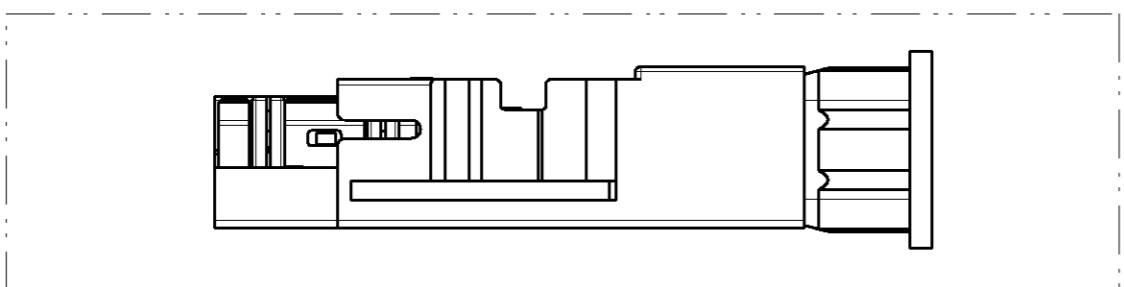
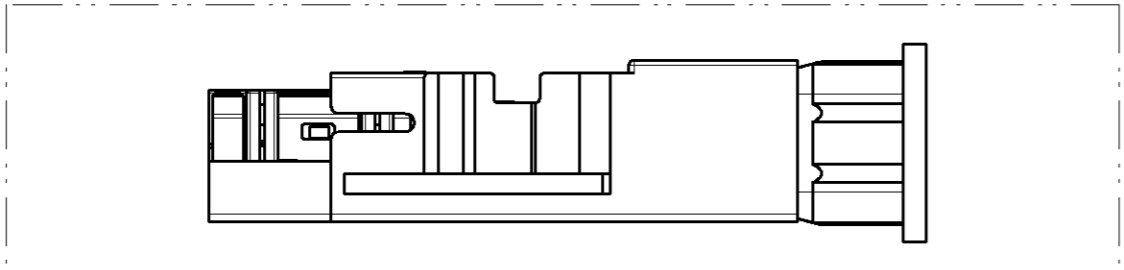

MT-RJ SECURE JACK XG MODULE ASSEMBLY

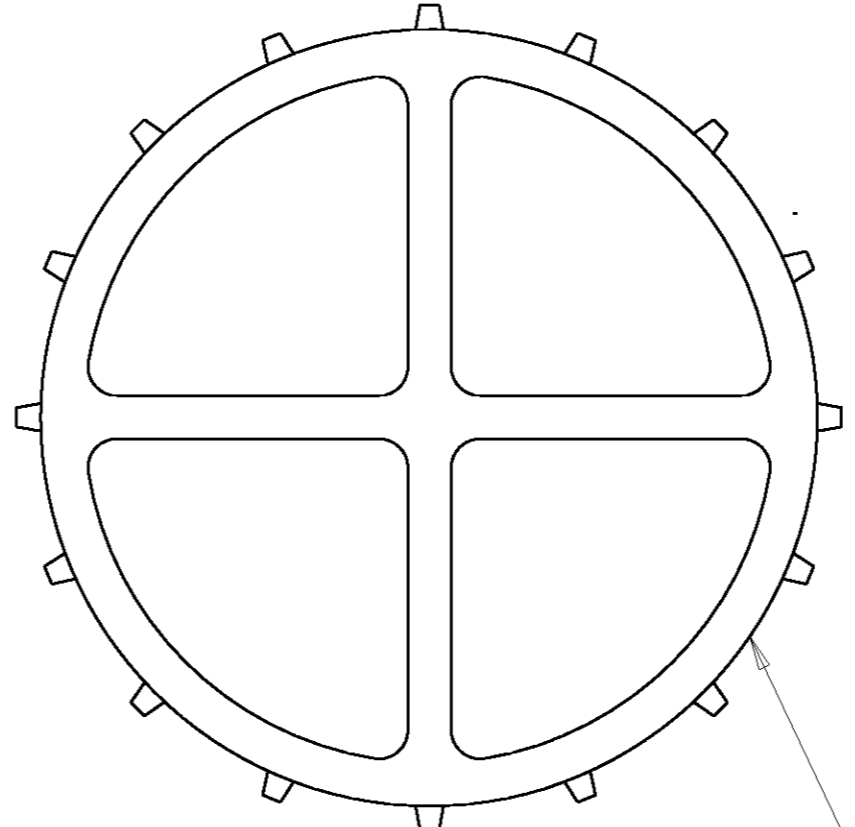

ICON WHEEL



MT-RJ ACTUATION KEY

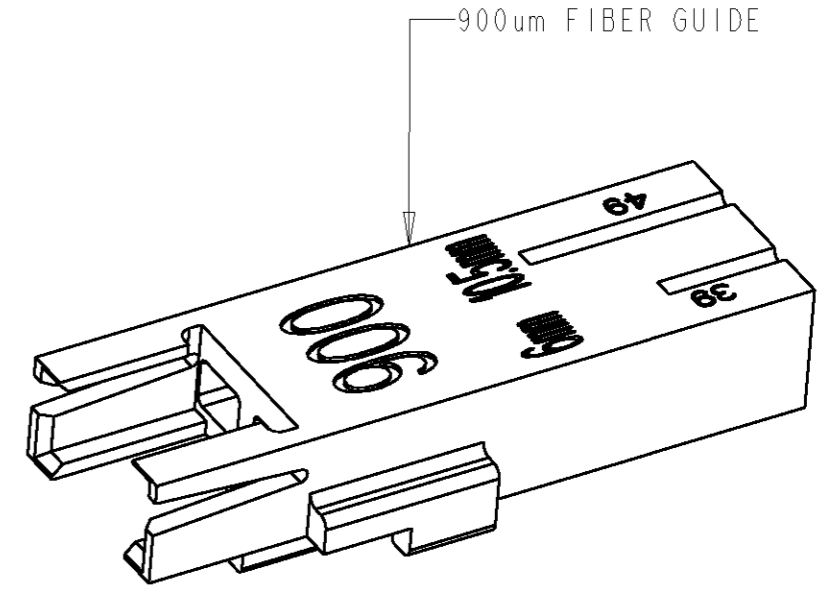

900um FIBER GUIDE

SCALE 3:1

DESCRIPTION	PART NUMBER
SLATE (K10)	1-6693949-0
ORANGE (K9)	6693949-9
VIOLET (K8)	6693949-8
BROWN (K7)	6693949-7
AQUA (K6)	6693949-6
ROSE (K5)	6693949-5
BLUE (K4)	6693949-4
GREEN (K3)	6693949-3
YELLOW (K2)	6693949-2
RED (K1)	6693949-1

THIS DRAWING IS A CONTROLLED DOCUMENT FOR AMP INCORPORATED. IT IS SUBJECT TO CHANGE AND THE CONTROLLING ENGINEERING ORGANIZATION SHOULD BE CONTACTED FOR THE LATEST REVISION.		DWN B. BRIGGS 01NOV2005 CHK D. KIRSCH 01NOV2005 APVD S. BUCHTER 07NOV2005	<b>AMP</b> AMP Incorporated Harrisburg, PA 17105-3608
DIMENSIONS: mm 	TOLERANCES UNLESS OTHERWISE SPECIFIED: 0 PLC ± 1 PLC ± 2 PLC ± 3 PLC ± 4 PLC ± ANGLES ± FINISH -	PRODUCT SPEC - APPLICATION SPEC - WEIGHT -	NAME MT-RJ SECURE JACK KIT, 6-PACK, XG, 50/125, 900um SIZE A2 CAGE CODE 00779 DRAWING NO. 6693949 SCALE NTS SHEET 1 OF 1 REV A
CUSTOMER DRAWING			