



Chipsmall Limited consists of a professional team with an average of over 10 year of expertise in the distribution of electronic components. Based in Hongkong, we have already established firm and mutual-benefit business relationships with customers from,Europe,America and south Asia,supplying obsolete and hard-to-find components to meet their specific needs.

With the principle of “Quality Parts,Customers Priority,Honest Operation,and Considerate Service”,our business mainly focus on the distribution of electronic components. Line cards we deal with include Microchip,ALPS,ROHM,Xilinx,Pulse,ON,Everlight and Freescale. Main products comprise IC,Modules,Potentiometer,IC Socket,Relay,Connector.Our parts cover such applications as commercial,industrial, and automotives areas.

We are looking forward to setting up business relationship with you and hope to provide you with the best service and solution. Let us make a better world for our industry!



Contact us

Tel: +86-755-8981 8866 Fax: +86-755-8427 6832

Email & Skype: info@chipsmall.com Web: www.chipsmall.com

Address: A1208, Overseas Decoration Building, #122 Zhenhua RD., Futian, Shenzhen, China





Curtis

We Build Confidence!

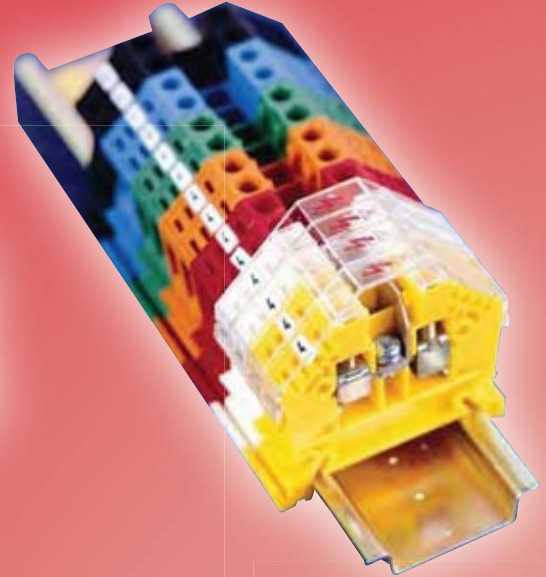

Terminal Blocks



Curtis Industries

A Div. of Powers Holdings, Inc.



Curtis Industries

A Division of Powers Holdings, Inc.

Curtis Industries is recognized as a leader in North American Style Terminal Blocks. We focus on five key areas to insure high quality and total customer satisfaction using the latest technology. These key areas include Customer Satisfaction, Design Engineering, Manufacturing, Quality, and On-Time Delivery.



Customer Satisfaction is carried out throughout Curtis. Customer interface with our friendly and knowledgeable Customer Service Representative where all the information needed for order entry, processing, shipping, pricing, and order expediting are immediately available electronically.



Design Engineering is able to create new designs to solve our OEM customer's requirements. Using the Solid Works modeling technology enables our engineers to design the optimum terminal blocks or custom control package.



Manufacturing uses proprietary techniques with semi and full automation to build in quality and reduce thru-put. We deliver 99.9% reliable product to meet our customer's quality objectives.



Manufacturing uses Cellular and Lean manufacturing technologies to maintain high quality, short lead time and lower costs. We deliver 99.9% reliable product to meet our customer's quality objectives.



On-Time Delivery is a focus for everyone at Curtis which has resulted in an on-time delivery greater than 98% on time.

Contents

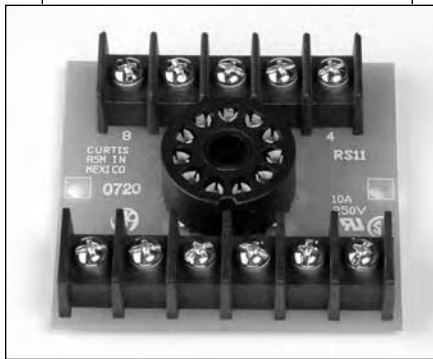
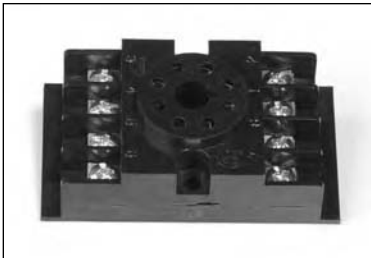
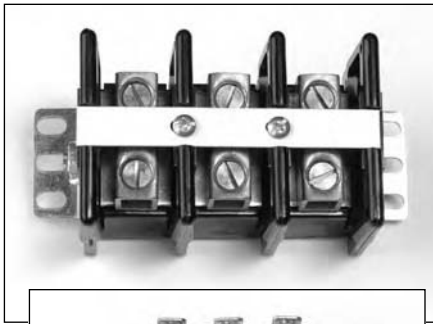

Selection Guide 2

BARRIER STYLE TERMINAL BLOCKS]

Single Row

SE/SEI 6
 32500 8
 37000/38000 10
 CB/CFT 16
 43000 20
 GFT/GB 24

Dual Row

1500 28
 2000 30
 M 34
 56000 36

High Voltage/Current

Series SW & DS 38
 Series W 40
 Types CDM 42
 Series 71000 44
 Types H & BT 46
 Types T & U 48
 Types L, O & S 50

RELAY SOCKETS]

Snap-In Socket Assemblies 54

CUS Series

CUS8 and CUS11 55
 CUS5, CUS12 and CUS16 55

RS Series

RS8, RS11 56
 RS2, RS4 and RS6 57
 RS12 and RS16 58
 RS14, RS15 58

Accessories 60

DIN RAIL TERMINAL BLOCKS]

Din Rail Terminal Block Features 62
 Multiple Wire Connections 63

Screw Connections

Single Level 64
 Dual Level Block 68

Screwless Connections

Single Level 70
 Single Level, Multi 71
 Ground Blocks 72

Fuse Blocks 73

Ground Blocks 75

Mounting Rails 77

Accessories 78

Curtis Industries Terminal Block Selection Guide

Barrier Style

Series/ Type	TERMINAL SPACINGS			TERMINAL TYPES				RATING		HOUSING			AGENCY Approvals		Catalog Page Number
	Center-to-Center Spacing	Wire Range (AWG)	Number of Terminals	Feed-Thru (Fully Insulated)	Feed Thru	Printed Circuit Surface (Fully Insulated)	Voltage (Varies with Application) see specifications	Current (Amps)	(Black) Phenolic *150°C (302°F)	Polyphenylene *110°C (230°F)	Thermoplastic-Poly *140°C (284°F)	Flammability	UL Recognition	CSA Certified	
SE/SEI	.250" (1/4") (6.35mm)	22 to 16	1 thru 26	•	•	•	•	250V	5			94V-0	•	•	6
32500	.325" (8.25mm)	22 to 14	1 thru 26		•	•	•	300V	15			94V-0	•	•	8
37000/ 38000	.375" (3/8") (9.52mm)	22 to 12	1 thru 26	•	•	•	•	300V	20			94V-0	•	•	10
CB/CFT	.375" (3/8") (9.52mm)	22 to 12	1 thru 26	•	•	•	•	600V	20			94V-0	•	•	16
43000	.4375" (7/16") (11.11mm)	22 to 12	1 thru 26	•	•	•	•	600V	30			94V-0	•	•	20
GFT/GB	.4375" (7/16") (11.11mm)	22 to 12	1 thru 26	•	•	•	•	600V	20	•	•	94V-0	•	•	24
1500	.375" (3/8") (9.52mm)	22 to 10	1 thru 22		•	•	•	300V	30			94V-0	•	•	28
2000	.4375" (7/16") (11.11mm)	22 to 10	1 thru 26		•	•	•	300V	20			94V-0	•	•	30
M	.50" (1/2") (12.7mm)	22 to 12	1 thru 24				•	300V	15	•		94V-1	•	•	34
5600	.563" (9/16") (14.29mm)	22 to 8	1 thru 22		•		•	600V	15-50	•		94V-0	•	•	36

Barrier Style High Voltage

Series/ Type	TERMINAL SPACINGS			MOUNTING METHOD		RATING		HOUSING			AGENCY Approvals		Catalog Page Number	
	Center-to-Center Spacing	Wire Range (AWG)	Number of Terminals	Surface	Snap-in Track Modular Assembly	Voltage	Current (Amps)	(Black) Phenolic *150°C (302°F)	Thermoplastic-Poly *130°C (266°F)	Polyamide (Nylon) *125°C (257°F)	Flammability	UL Recognition		CSA Certified
SW/ DSW	.375" (3/8") (9.52mm)	22 to 8	2 thru 192		•	600V	25-50			•	94V-2	•	•	38
W	.4375" (7/16") (11.11mm)	22 to 4	2 thru 164		•	600V	75	•			94V-1	•	•	40
CDM	.547" (35/64") (13.86mm)	22 to 10	1 thru 50	•		600V	30		•		94V-0	•	•	42
71000	.629" (15.97mm)	22 to 1	2 thru 6		•	600V	86		•		94V-0	•	•	44
H/BT	.652" (16.56mm)	H - 16 to 4 BT - 22 to 10	1 thru 30	•		600V	75-30		•		94V-0	•	•	46
T/U	1.16" (29.46mm)	T - 6 to 1/0 U - 6 to 250 MCM	1 thru 6	•		600V	125-250	•			94V-1	•	•	48
L	1.16" (29.46mm)	Up to 1	1 thru 12	•		600V	100				94V-1	•	•	50
O	1.86" (47.24mm)	Up to 1/0	1 thru 4	•		600V	125	•			94V-1	•	•	50
S	2.42" (61.47mm)	Up to 4/0	1 thru 4	•		600V	225	•			94V-1	•	•	50



Relay Sockets

Series/ Type	TERMINAL SPACINGS			STYLE		RELAYS					RATING		HOUSING		Catalog Page Number
				Octal	Square	SPDT	2PDT	3PDT	4PDT	6PDT	Voltage (Varies with Application) see specifications	Current (Amps)	Thermoplastic •110°C (230°F)		
	Center-to- Center Spacing	Wire Range (AWG)	Sockets	•	•	•	•	•	•						
CUS 8		22 to 12	8-pin	•		•					300V	10	•	55	
CUS 11			11-pin												•
CUS 5		22 to 14	5-pin	•		•					250V	15	•	55	
CUS 12			8-pin			•									
CUS 16			11-pin			•									
RS8	.4375" (7/16") (11.11mm)	22 to 12	8-pin	•		•					250V	10	•	56	
RS11			11-pin			•									
RS2	.25" (1/4") (6.35mm)	22 to 16	10-pin	•		•			•		125V	5	•	57	
RS4			16-pin												
RS6			22-pin			•									
RS12	.4375" (7/16") (11.11mm)	22 to 12	8-pin	•		•					260V	10	•	58	
RS16			11-pin			•									
RS14	.25" (1/4") (6.35mm)	22 to 16	14-pin	•		•			•		125V	5	•	59	
RS15			15-pin			•									

Din Rail

Series/Type	TERMINAL SPACINGS			STYLE		RATING		HOUSING		Catalog Page Number
				Screw	Screwless	Voltage (Varies with Application) see specifications	Current (Amps)	Thermoplastic Polyamide •125°C (230°F)	V-0 Self-Extinguishing	
	Spacing	Wire Range (AWG)	Wire Cross Section							
Single Level	5-26mm	24 to 10	2.5-70mm	•		800V	24-80	•		64
Dual Level	6 mm	24 to 10	4.0-6.0mm	•		600V	30	•		66
Triple Level	5.3 & 6mm	26 to 14	2.5mm	•		250V	24	•		69
Single Level	5mm	24 to 8	2.5-8.0mm		•	600V	20	•		70
Single-Multi Level	5mm	24 to 8	2.5-8.0mm		•	600V	20	•		70
Ground		24 to 10			•			•		72
Fuse Block	10mm		11/4-5.0mm	•		600V	15-30	•		73
Din Ground	2 - 25mm	30 to 12	2-25mm	•		300-750V	13.5-15		•	75



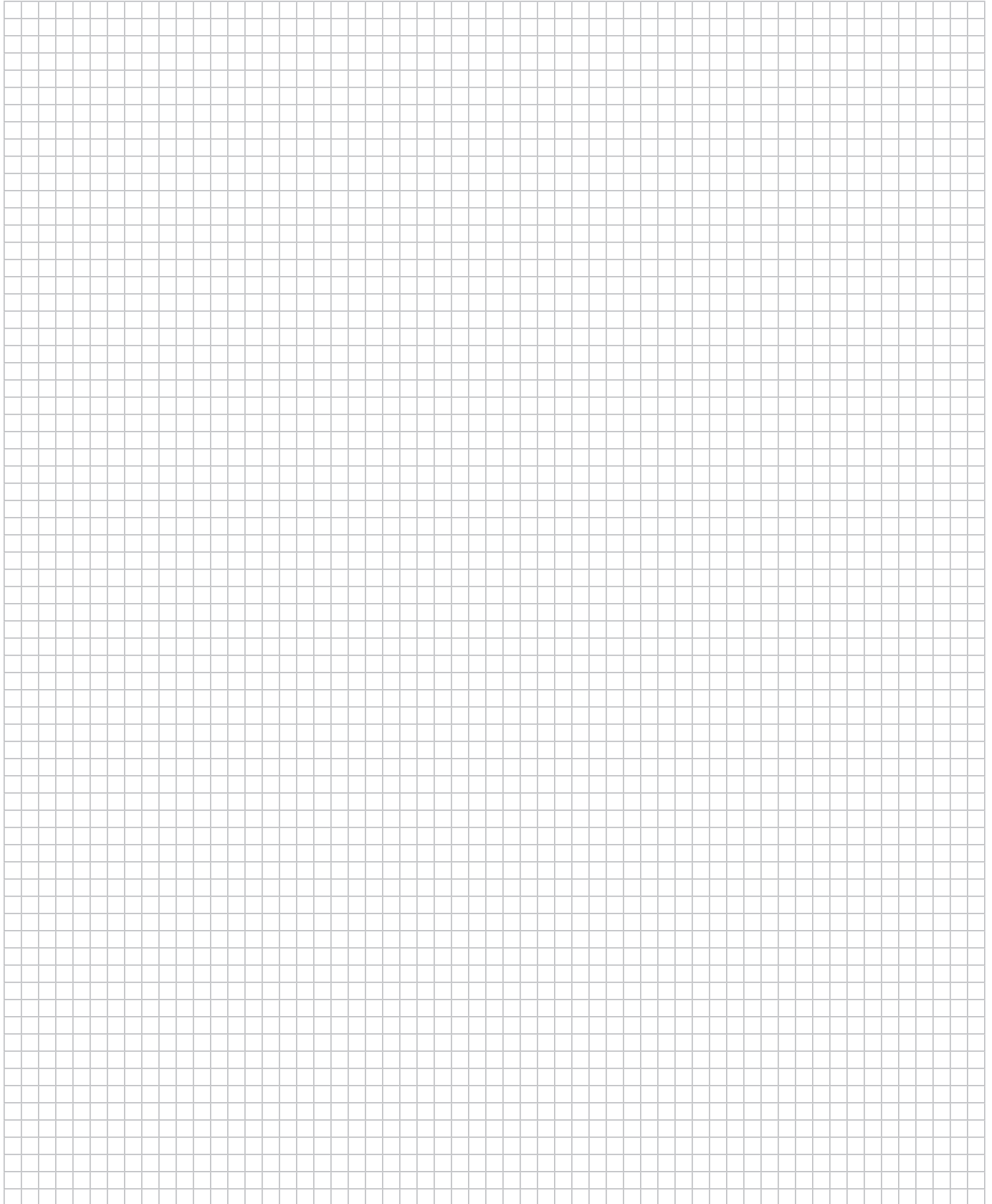

BARRIER STYLE TERMINAL BLOCKS]

Single Row

Dual Row

High-Voltage/Current

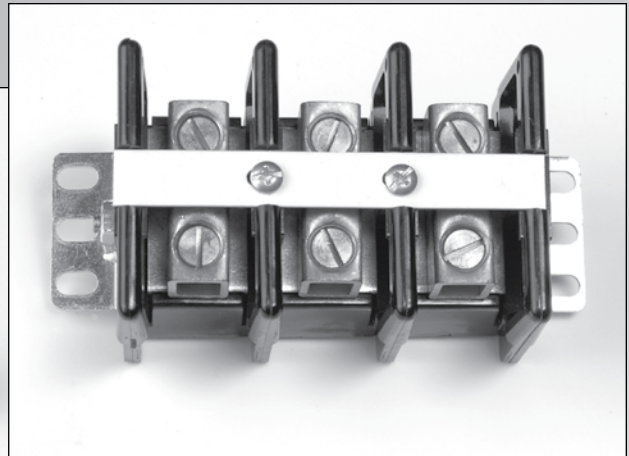
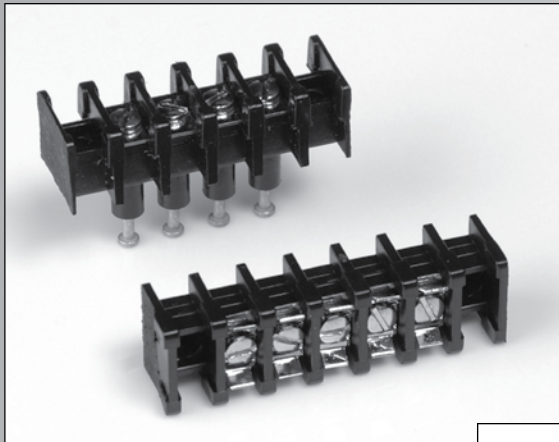

Curtis Industries
A Division of Powers Holdings, Inc.

Series SE/SEI .250" (1/4") 6.35mm Center-to-Center Spacing

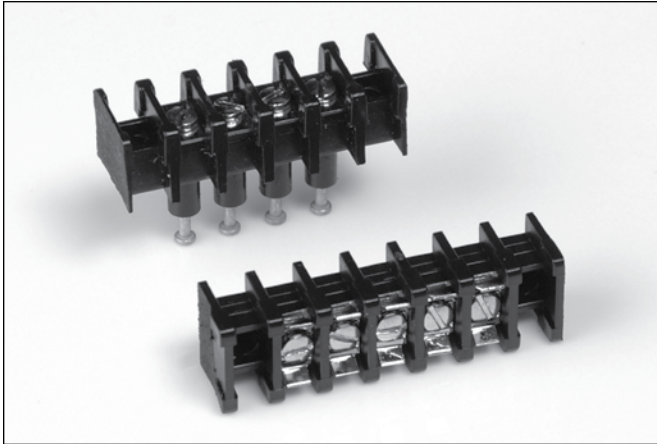

Features:

- **Miniature Feed-Thru, Printed Circuit and Surface Connection** – SE Series miniature terminal blocks are designed for applications requiring the compactness and versatility of the SEI Series without full feed-thru insulation.
- **Barrier-Type Construction** – Blocks are made of high-impact, break-resistant thermoplastic molding with integrally mounted .116" diameter mounting holes. One thru 26 terminals on 1/4" center-to-center spacing.
- **Terminal Flexibility** – External terminals available in two No. 2-56 screw designs. Internal terminals include an .047" diameter printed circuit pin, and turret-type solder pins.
- **Wire Sizes** – No. 2-56 screws. UL recognized for No. 22AWG to No. 16AWG.
- **Recognition and Listing** – UL recognized
- **Standoffs** – SEPX and SEFX are now supplied with .020" standoffs for ease in cleaning after soldering.

Single Row

BARRIER STYLE

VARIATIONS

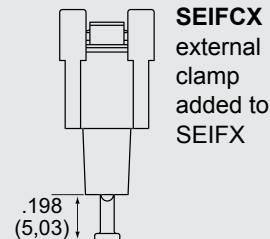
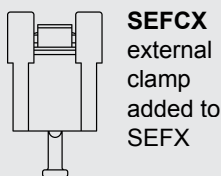
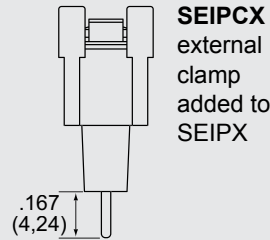
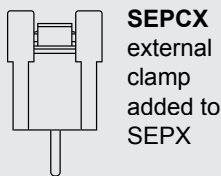
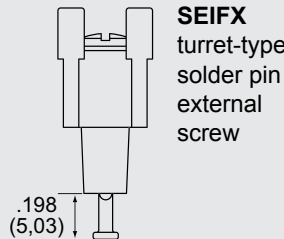
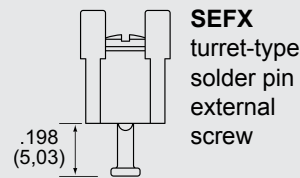
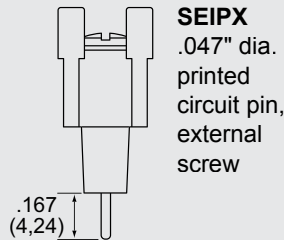
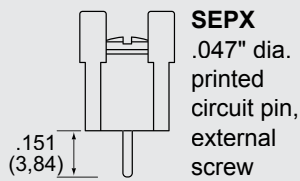

 Recognized under the Components Program of Underwriters Laboratories, Inc. Standard 1059, Guide No. XCFR2, File No. E62557.

 Guide No. 22.2 No. 158, Report No. LR39186-1.

Internal Terminal Designations

- SEPX, SEIPX** printed circuit board design with .047" tin-plated brass pin
- SEFX, SEIFX** tin-plated brass turret-type solder pin

External Terminal Designations

- SEPX, SEFX, SEIPX, SEIFX** No. 2-56 plated steel* terminal screw accepting up to No. 16 AWG wire
- SEPCX, SEFCX, SEIPCX, SEIFCX** Nickel-plated brass surface clamp with No. 2-56 plated steel screw to eliminate lugging. Accepts wire up to No. 16AWG

PC BOARD DRILLING DIMENSIONS

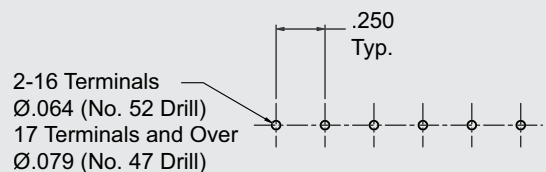

Specifications:

Center-to-Center Spacing: .250" (6.35mm)

Wire Range: UL recognized for No. 22AWG to No. 16AWG. Models SEIPX, SEIFX, SEPX and SEFX with standard No. 2-56 plated steel screws are UL recognized "for factory wiring only." Models SEPCX, SEFCX, SEIPCX and SEIFCX are UL recognized "for field wiring" when ordered with special No. 2-56 stainless steel screw.

No. of Terminals: 1 thru 26

Voltage Rating: UL & CSA – 150 volts – General Industrial
250 volts – Commercial Appliance

Tightening Torque: Wire Clamp with stainless steel screw 3 in.-lbs.

Current Rating: 5 amps UL

Housing:

Material Polyphenylene Oxide
 Continuous Use Temp. (UL Index) 110° C (230° F)
 Flammability Rating 94V-0
 Water Absorption (24 hrs. % wt. gain) .06%
 Chemical Resistance Resistant to inorganic bases and acids – for organic substances contact factory for specific resistances.

Breakdown Voltage:

Terminal - Terminal 3,600 Typ.
 Terminal - Ground 4,700 Typ.

How to Order

SEI and SE Series terminal blocks are ordered by listing a composite number made up of the model designation followed by the number of poles required for the application. Suffixes are used as follows:

R denotes model less mounting positions

* The SEPX and SEFX are made with .020" standoffs for ease in cleaning after the soldering operation

Series SE/SEI Dimensions

NOTE: mm dim. are shown in parentheses

Number of Terminals	Series SE/SEI With Mounting Ends				Without Mounting Ends	
	Dimensions					
	A ± .031 Overall Dimensions (O.D.)		B ± .031 Mounting Dimensions (M.D.)		C ± .031 Less Mounting Positions	
	Inches	Metric (mm)	Inches	Metric (mm)	Inches	Metric (mm)
1	.781	19.84	.500	12.70	.375	9.52
2	1.031	26.19	.750	19.05	.625	15.87
3	1.281	32.54	1.000	25.40	.875	22.22
4	1.531	38.89	1.250	31.75	1.125	28.57
5	1.187	45.24	1.500	38.10	1.375	34.92
6	2.031	51.59	1.750	44.45	1.625	41.27
7	2.281	57.94	2.000	50.80	1.875	47.62
8	2.531	64.29	2.250	57.15	2.125	53.97
9	2.781	70.64	2.500	63.50	2.375	60.32
10	3.031	76.99	2.750	69.85	2.625	66.67
11	3.281	83.34	3.000	76.20	2.875	73.02
12	3.531	89.69	3.250	82.55	3.125	79.37
13	3.781	96.04	3.500	88.90	3.375	85.72
14	4.031	102.39	3.750	95.25	3.625	92.07
15	4.281	108.74	4.000	101.60	3.875	98.42
16	4.531	115.09	4.250	107.95	4.125	104.77
17	4.781	121.44	4.500	114.30	4.375	111.12
18	5.031	127.79	4.750	120.65	4.625	117.47
19	5.281	134.14	5.000	127.00	4.875	123.82
20	5.531	140.49	5.250	133.35	5.125	130.17
21	5.781	146.84	5.500	139.70	5.375	136.52
22	6.031	153.19	5.750	146.05	5.625	142.87
23	6.281	159.54	6.000	152.40	5.875	149.22
24	6.531	165.89	6.250	158.75	6.125	155.57
25	6.781	172.24	6.500	165.10	6.375	161.92
26	7.031	178.59	6.750	171.45	6.625	168.27

Dimensions shown are ± 0.030"

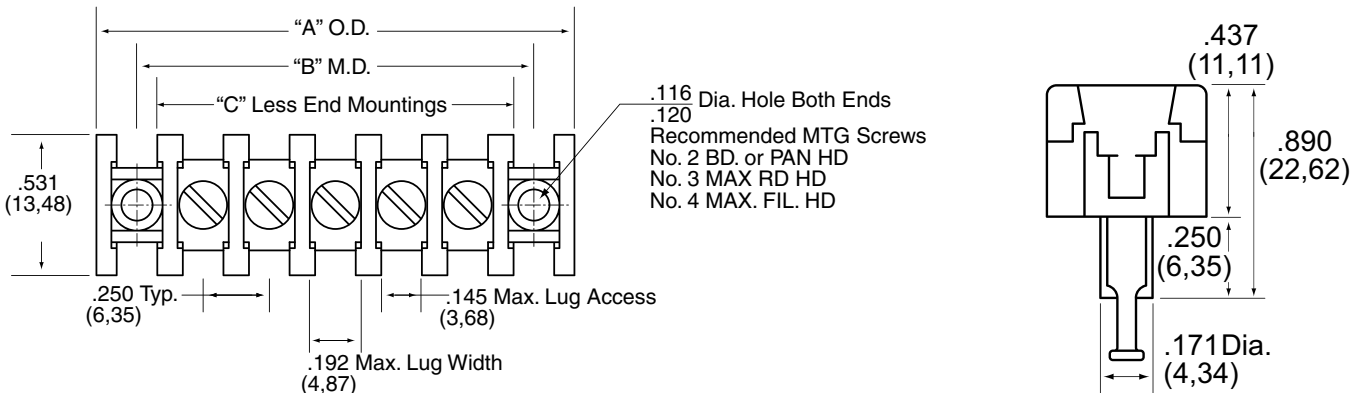

Series 32500 .325" Center-to-Center Spacing

Single Row

BARRIER STYLE

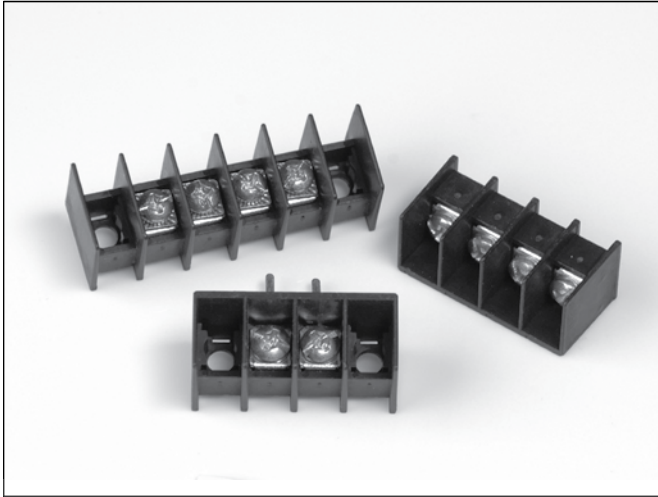

32500 Surface Mount With or Without Mounting Ends

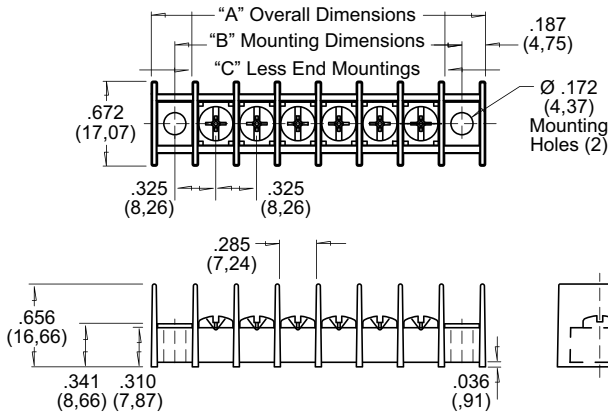

Features:

- **Complete Line of .325" Offset Blocks** – Including base mount, P.C. Pin, wire wrap, turret, and right angle terminals
- **Open or Tri Barrier Designs** – To meet your wiring requirements
- **UL & CSA Recognized** – With a 94 V-O flammability rating
- **Molded in Standoffs** – To aid in the board cleaning process
- **A Multitude of Screw and Wire Terminals Available** – Including wire clamps, wire ready screws, and combo head screws

UL Recognized under the Components Program of Underwriters Laboratories, Inc. Standard 1059, Guide No. XCFR2, File No. E62557.

CSA Guide No. 22.2 No. 158, Report No. LR39186-1.

32500 Tri-Barrier Surface Mount With or Without Mounting Ends

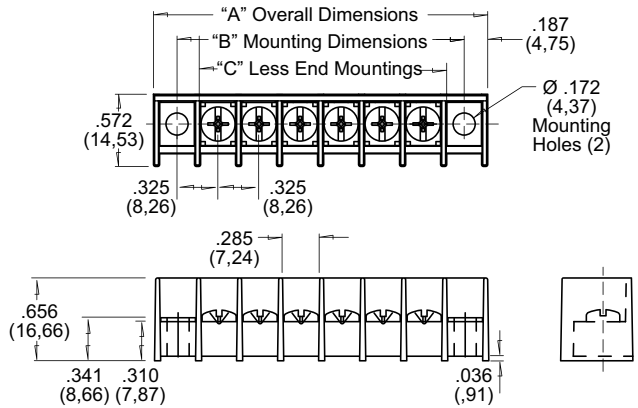

How to Order 325 X X X XX X

MOLDING DESIGN

- 0 = Open Back w/ Mounting Ends
- 1 = Open Back w/o Mounting Ends
- 2 = Tri Barrier w/ Mounting Ends
- 3 = Tri Barrier w/o Mounting Ends

INSERT OR BOTTOM TERMINATION DESIGN

- 0 = Base Mount Insert
- 1 = Printed Circuit Pin
- 2 = Wire Wrap Pin
- 3 = Turret Type Pin
- 4 = Right Angle Printed Circuit Pin

SPECIALS OR OPTIONAL DESIGNS

- 0 = None
- A-Z = Custom Configuration

NUMBER OF POSITIONS

1 thru 26, Available in One to Twenty-Six Positions

HARDWARE OR TOP TERMINATION DESIGN

- 0 = Steel Combo Head Screw
- 1 = Wire Clamp Head Screw
- 2 = Brass Combo
- 3 = Stainless Steel Screw
- 5 = Supplied w/o Screws
- 6 = Quick Connects
- 8 = Captivated Steel Combo Head
- 9 = Captivated Wire Clamp



Specifications:

Center-to-Center Spacing: .325" (.825mm)

Wire Range: No. 22AWG to 14AWG

No. of Terminals: 1 thru 26 (28 without mounting holes)

Voltage Rating: 300V

Tightening Torque: 9 in. lb.

Current Rating: 15 amps UL
(20 Amps with 12AWG & Lugs)

Housing:

Material Polypropylene

Continuous Use

Temp. (UL Index) 105°C (221°F)

Flammability Rating 94V-0

Water Absorption
(24 hrs. % wt. gain) .03%

PC BOARD DRILLING DIMENSIONS

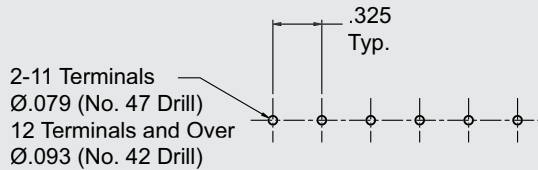

Series 32500 Open Back

0 – Flush Mount

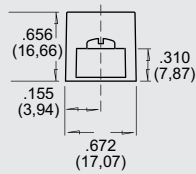

1 – PC Pin

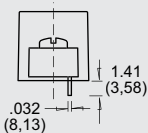

2 – Wire Wrap

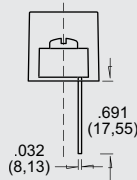

3 – Turret Type

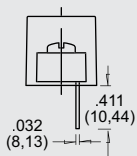

4 – Right Angle PC Pin

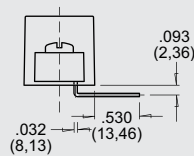

Series 32500 Tri-Barrier

0 – Flush Mount

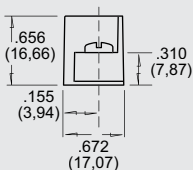

1 – PC Pin

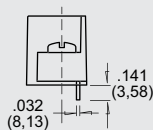

2 – Wire Wrap

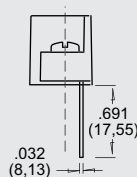

3 – Turret Type

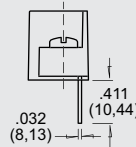

4 – Right Angle PC Pin

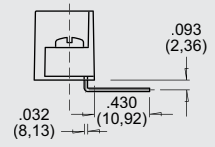

Number of Terminals	Series 32500 With Mounting Ends				Without Mounting Ends	
	Dimensions					
	A ± .031 Overall Dimensions (O.D.)		B ± .031 Mounting Dimensions (M.D.)		C ± .031 Less Mounting Ends	
	Inches	Metric (mm)	Inches	Metric (mm)	Inches	Metric (mm)
1	1.023	25.98	.650	16.51	.373	9.47
2	1.348	34.24	.975	24.77	.698	17.73
3	1.673	42.49	1.300	33.02	1.023	25.98
4	1.998	50.75	1.625	41.30	1.348	34.24
5	2.323	59.00	1.950	49.53	1.673	42.49
6	2.648	67.26	2.275	57.79	1.998	50.75
7	2.973	75.51	2.600	66.04	2.323	59.00
8	3.298	83.77	2.925	74.30	2.648	67.25
9	3.623	92.02	3.250	82.55	2.973	75.51
10	3.948	100.28	3.575	90.81	3.298	83.77
11	4.273	108.53	3.900	99.06	3.623	92.02
12	4.598	116.79	4.225	107.32	3.948	100.28
13	4.923	125.04	4.550	115.57	4.273	108.53
14	5.248	133.30	4.875	123.83	4.598	116.79
15	5.573	141.55	5.200	132.08	4.923	125.04
16	5.898	149.81	5.525	140.34	5.248	133.30
17	6.223	158.06	5.850	148.59	5.573	141.55
18	6.548	166.32	6.175	156.85	5.898	149.81
19	6.873	174.57	6.500	165.1	6.223	158.06
20	7.198	182.83	6.825	173.36	6.548	166.32
21	7.523	191.08	7.150	181.61	6.873	174.57
22	7.848	199.34	7.475	189.87	7.198	182.83
23	8.173	207.59	7.800	198.12	7.523	191.08
24	8.498	215.85	8.125	206.38	7.848	199.34
25	8.823	224.10	8.450	214.63	8.173	207.60
26	9.148	232.36	8.775	222.89	8.498	215.85
27					8.823	224.10
28					9.148	232.36

Dimensions shown are ± 0.030"



Series 37000/38000 .375" (3/8") 9.52mm Center-to-Center Spacing

Single Row

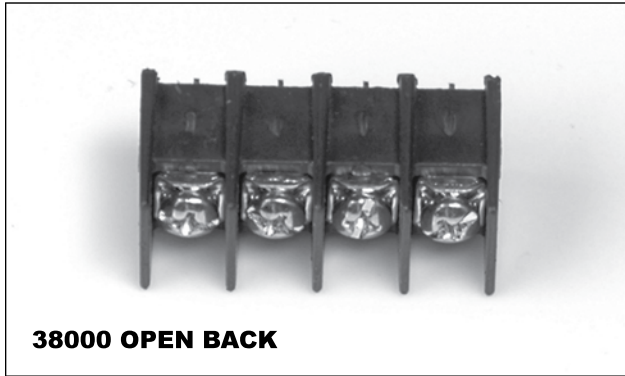
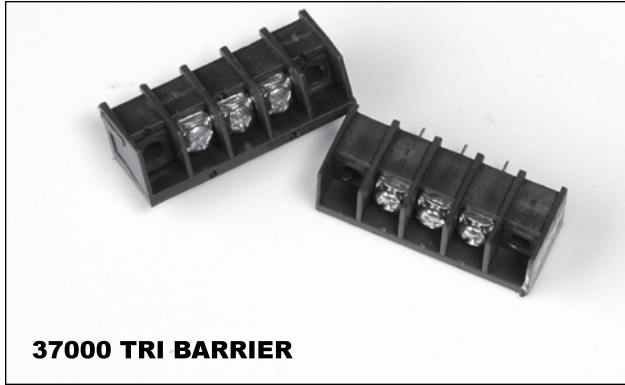

Features:

- Complete line of .375" centerline terminal block styles. Terminal blocks come in surface mount, PC mount, panel mount, and feed-thru styles with a wide variety of top and bottom terminations available
- Compliant contact design virtually eliminates solder joint fractures due to pin twist
- Standoffs are molded into blocks to prevent trapping solder flux and to aid in the board cleaning process
- Broad wire range. The 37000/38000 Series terminal blocks will accommodate wire sizes up to 12AWG
- Full line of accessories complements the 37000/38000 Series terminal blocks, offering greater design flexibility
- All Curtis terminal blocks for electronic applications are made from self-extinguishing material rated 94V-0 by Underwriters Laboratories, Inc.
- Customized terminal blocks are available for special application by consulting any authorized Curtis distributor, Curtis representative, or by contacting the Curtis factory direct



Recognized under the Components Program of Underwriters Laboratories, Inc. Standard 1059, Guide No. XCFR2, File No. E62557.

Guide No. 22.2 No. 158, Report No. LR39186-1.

BARRIER STYLE

SERIES 38000 VARIATIONS

1 - Printed Circuit Pin

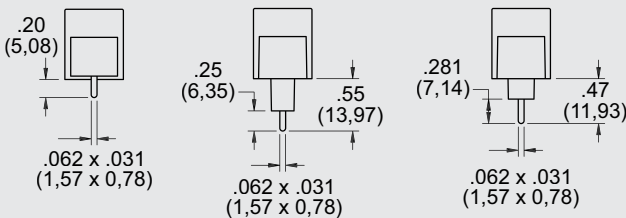

2 - Turret Type Solder Terminal

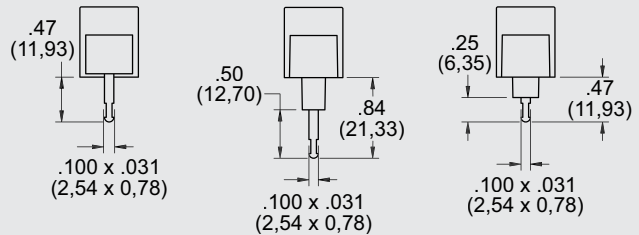

3 - .110" Quick Connect

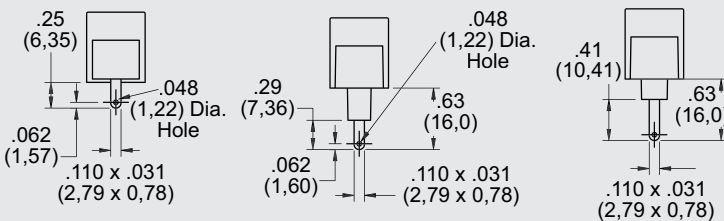

4 - .187" Quick Connect

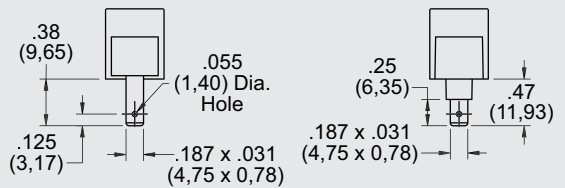

5 - .250" Quick Connect

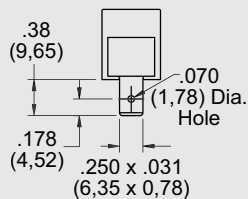

6 - Wire Wrap/Printed Circuit Pin

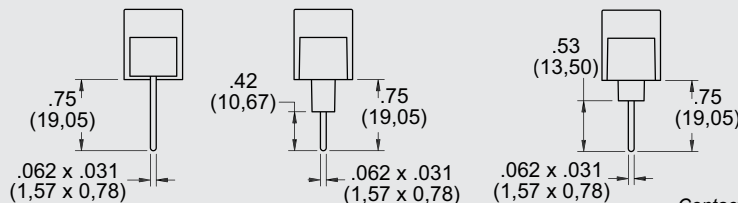

7 - Wire Wrap/Right Angle Printed Circuit Pin

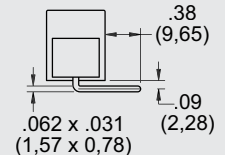

NOTE: Standard bend shown. Contact factory for other bend dimensions.



Specifications:

Center-to-Center Spacing: .375"
(9.52mm)

Wire Range: No. 22AWG to No. 12AWG

No. of Terminals: 1 thru 26 (28 positions on surface mount without mounting ends)

Voltage Rating: 300V

Tightening Torque:

Wire Binding Screw 9 in.-lb.
Wire Clamp 9 in.-lb.

Current Rating: 20 amps

Housing:

Material Polypropylene
Continuous Use
Temp. (UL Index) 105°C
Flammability Rating 94V-0
Water Absorption
(24 hrs. % wt. gain) .03%
Chemical Resistance Excellent

Breakdown Voltage:

Terminal - Ground 3,000V Typ.
4,700 Typ.

Terminals: Brass, Tin-plated

Series 37000 and 38000 With Mounting Ends							Without Mounting Ends	
Number of Terminals	Dimensions							
	A ± .031 Overall Dimensions (O.D.)		B ± .031 Mounting Dimensions (M.D.)		C ± .031 Less Mounting Ends		A ± .031 Less Mounting Ends	
	Inches	Metric (mm)	Inches	Metric (mm)	Inches	Metric (mm)	Inches	Metric (mm)
1	1.200	30.48	.750	19.05	.450	11.43	—	—
2	1.575	40.01	1.125	28.58	.825	20.96	.825	20.96
3	1.950	49.53	1.500	38.1	1.200	30.48	1.200	30.48
4	2.325	59.06	1.875	47.63	1.575	40.01	1.575	40.01
5	2.700	68.58	2.250	57.15	1.950	49.53	1.950	49.53
6	3.075	78.11	2.625	66.68	2.325	59.06	2.325	59.06
7	3.450	87.63	3.000	76.2	2.700	68.58	2.700	68.58
8	3.825	97.16	3.375	85.73	3.075	78.11	3.075	78.11
9	4.200	106.68	3.750	95.25	3.450	87.63	3.450	87.63
10	4.575	116.21	4.125	104.78	3.825	97.16	3.825	97.16
11	4.950	125.73	4.500	114.3	4.200	106.68	4.200	106.68
12	5.325	135.26	4.875	123.83	4.575	116.21	4.575	116.21
13	5.700	144.78	5.250	133.35	4.950	125.73	4.950	125.73
14	6.075	154.31	5.625	142.88	5.325	135.26	5.325	135.26
15	6.450	163.83	6.000	152.4	5.700	144.78	5.700	144.78
16	6.825	173.36	6.375	161.93	6.075	154.31	6.075	154.31
17	7.200	182.88	6.750	171.45	6.450	163.83	6.450	163.83
18	7.575	192.41	7.125	180.98	6.825	173.36	6.825	173.36
19	7.950	201.93	7.500	190.5	7.200	182.88	7.200	182.88
20	8.325	211.48	7.875	200.03	7.575	192.41	7.575	192.41
21	8.700	220.98	8.250	209.55	7.950	201.93	7.950	201.93
22	9.075	230.51	8.625	219.08	8.325	211.46	8.325	211.46
23	9.450	240.03	9.000	228.6	8.700	220.98	8.700	220.98
24	9.825	249.56	9.375	238.13	9.075	230.51	9.075	230.51
25	10.200	259.08	9.750	247.65	9.450	240.03	9.450	240.03
26	10.575	268.61	10.125	257.18	9.825	249.56	9.825	249.56
27							10.200	259.08
28							10.575	268.61

Dimensions shown are ± 0.030"

SERIES 37000 VARIATIONS

1 – Printed Circuit Pin

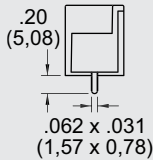

2 – Turret Type Solder Terminal

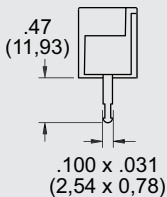

3 – .110" Quick Connect

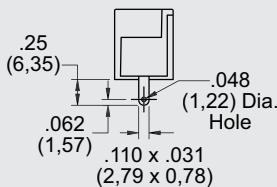

4 – .187" Quick Connect

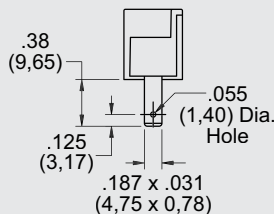

5 – .250" Quick Connect

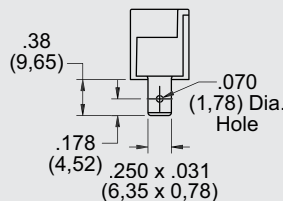

6 – Wire Wrap/Printed Circuit Pin

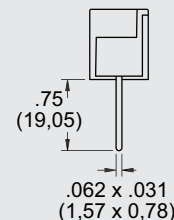

7 – Wire Wrap/Right Angle Printed Circuit Pin

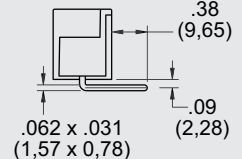

Series 37000/38000

Series 37000 Surface Mount with Mounting Ends

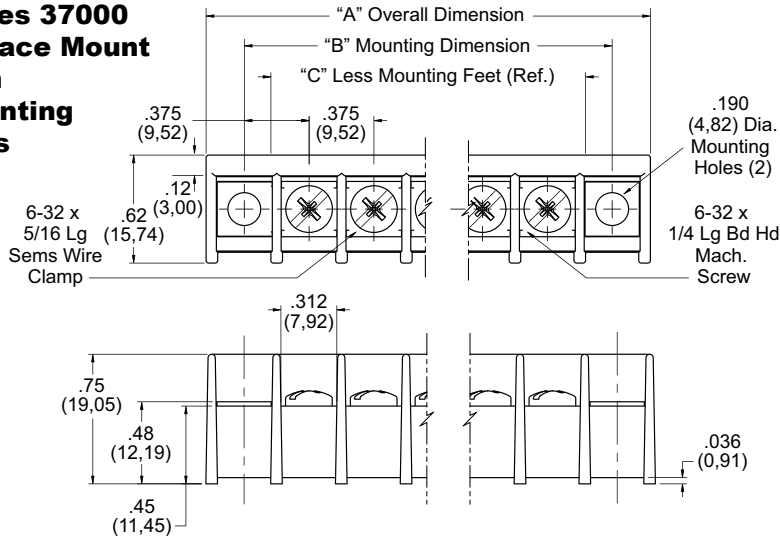

Series 37000 Surface Mount without Mounting Ends

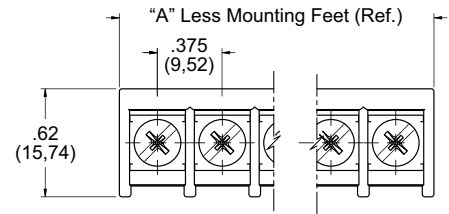

Single Row

BARRIER STYLE

How to Order T37 X X X XX X

MOLDING DESIGN

- 0 = Surface Mount w/ Mounting Ends
- 1 = Surface Mount w/o Mounting Ends

INSERT OR BOTTOM

TERMINATION DESIGN

- 0 = Surface Mount, No Bottom Termination
- 1 = Printed Circuit Pin
- 2 = Turret Type Solder Terminal
- 3 = Quick Connect .110"
- 4 = Quick Connect .187"
- 5 = Quick Connect .250"
- 6 = Wire Wrap Pin
- 7 = Right Angle Printed Circuit

SPECIALS OR OPTIONAL DESIGNS

- 0 = None
- A-Z = Custom Configuration

NUMBER OF POSITIONS

- 1 thru 26, Available in One to Twenty-Six Positions (28 Surface Mounts without Mounting Ends)

HARDWARE OR TOP TERMINATION DESIGN

- 0 = Nickel Plated Steel Screw, Standard
- 1 = Wire Clamp Screws
- 2 = Nickel Plated Brass Screws
- 3 = Stainless Steel Screws
- 5 = Without Screws
- 6 = Quick Connects, Screw Type*
- 8 = Captivated Screw

PC BOARD DRILLING DIMENSIONS

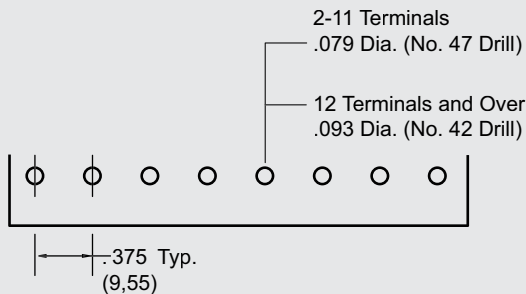

RECOMMENDED PANEL CUTOUT DIMENSIONS

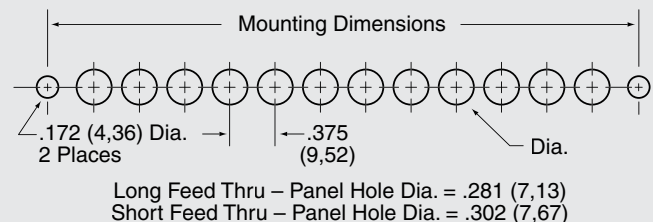

Series 38000 Surface Mount without Mounting Ends

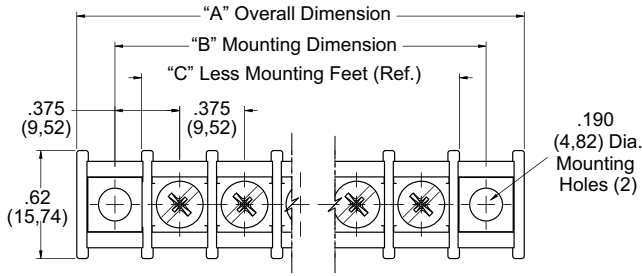

Series 38000 Short Feed-Thru

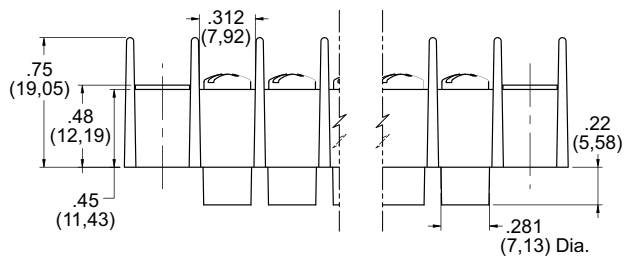

Series 38000 Base Mount

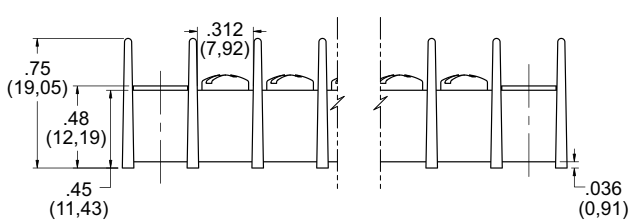

Series 38000 Long Feed-Thru

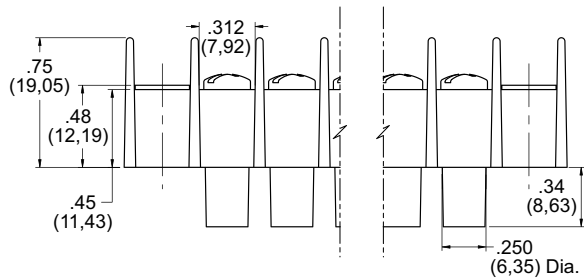

How to Order T38 X X X XX X

MOLDING DESIGN

- 0 = Surface Mount w/ Mounting Ends
- 1 = Surface Mount w/o Mounting Ends
- 2 = Insulated Feed Thru .250 Diameter w/ Mounting Ends
- 3 = Insulated Feed Thru .250 Diameter w/o Mounting Ends
- 4 = Insulated Feed Thru .281 Diameter w/ Mounting Ends
- 5 = Insulated Feed Thru .281 Diameter w/o Mounting Ends

INSERT OR BOTTOM TERMINATION DESIGN

- 0 = Surface Mount, No Bottom Termination
- 1 = Printed Circuit Pin
- 2 = Turret Type Solder Terminal
- 3 = Quick Connect .110"
- 4 = Quick Connect .187"
- 5 = Quick Connect .250"
- 6 = Wire Wrap Pin
- 7 = Right Angle Printed Circuit

SPECIALS OR OPTIONAL DESIGNS

- 0 = None
- A-Z = Custom Configuration

NUMBER OF POSITIONS

1 thru 26, Available in One to Twenty-Six Positions (28 Surface Mounts without Mounting Ends)

HARDWARE OR TOP TERMINATION DESIGN

- 0 = Nickel Plated Steel Screw, Standard
- 1 = Wire Clamp Screws
- 2 = Nickel Plated Brass Screws
- 3 = Stainless Steel Screws
- 5 = Without Screws
- 6 = Quick Connects, Screw Type*
- 8 = Captivated Screw

RECOMMENDED PANEL CUTOUT DIMENSIONS

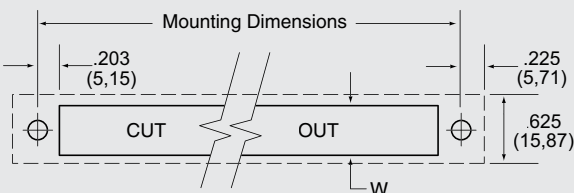

SURFACE MOUNT STYLES

- .187 (4,75) Tab W = .45 (11,34)
- .250 (6,35) Tab
- .110 (2,79) QC Wire Wrap Solder Tab W = .38 (9,65)



Series 37000/38000

Series 37000 Accessories

QUICK-CONNECT TERMINALS .020 X .187

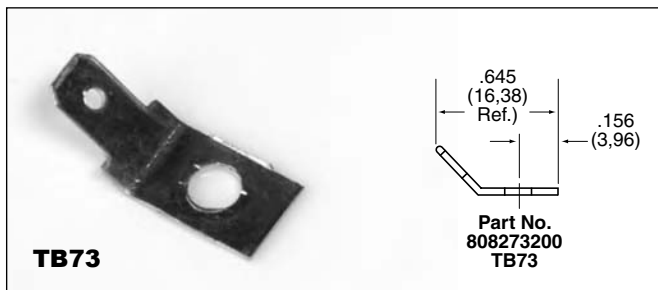
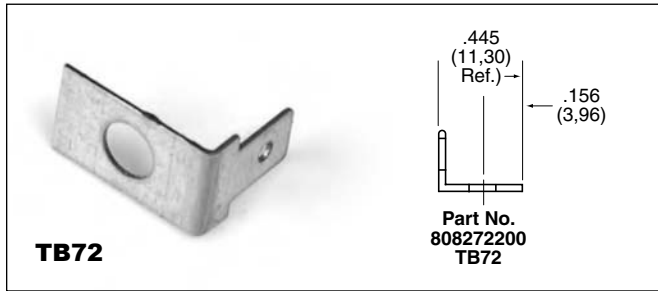
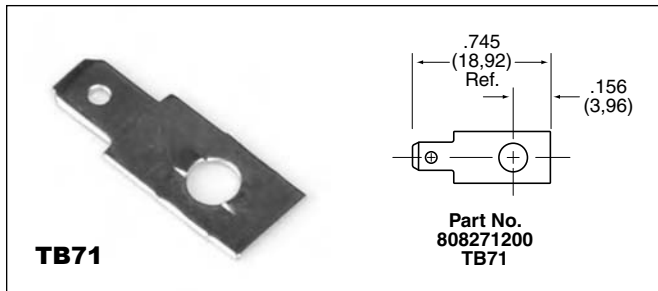

Single Row

BARRIER STYLE

Series 37000/38000 Accessories

TERMINAL BLOCK JUMPERS

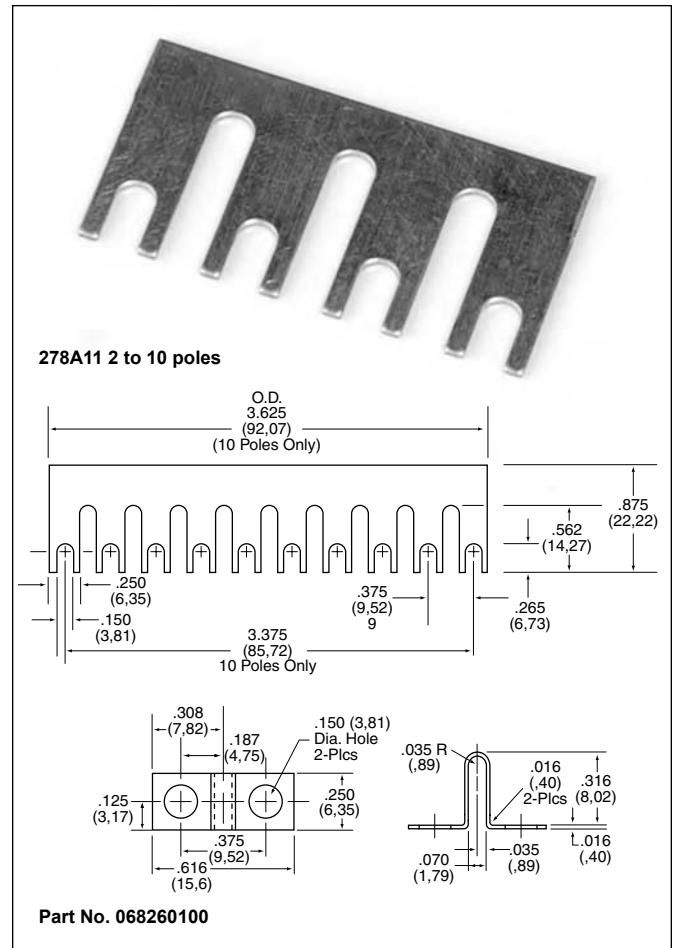

MARKING STRIPS

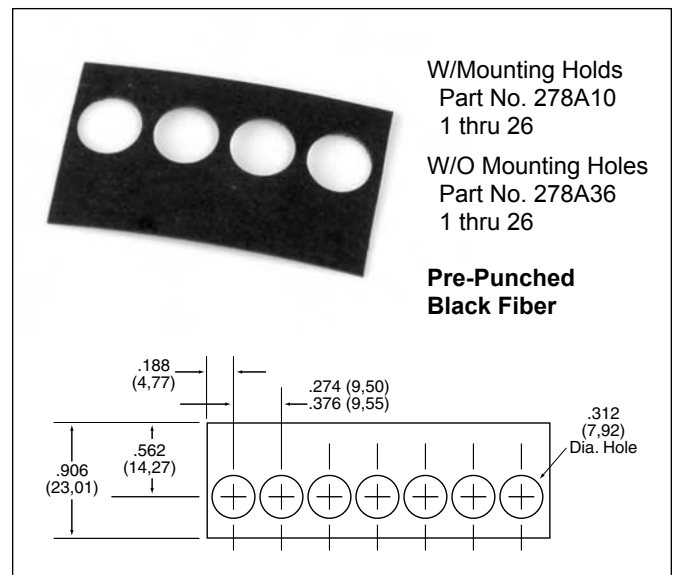

Series 38000 Accessories

QUICK-CONNECT TERMINALS .020 x .187"

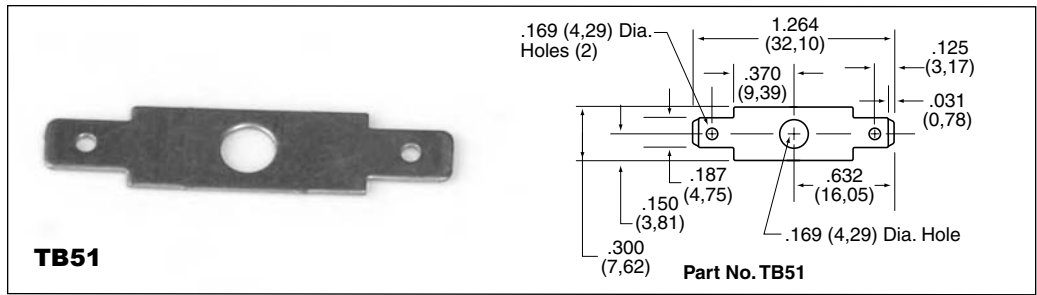

TB51

Technical drawing for Part No. TB51 showing dimensions: .169 (4,29) Dia. Holes (2), 1.264 (32,10), .125 (3,17), .370 (9,39), .031 (0,78), .187 (4,75), .632 (16,05), .169 (4,29) Dia. Hole, .150 (3,81), .300 (7,62).



TB52

Technical drawing for Part No. TB52 showing dimensions: .545 (13,84) Ref., .500 (12,70), .250 (6,35).

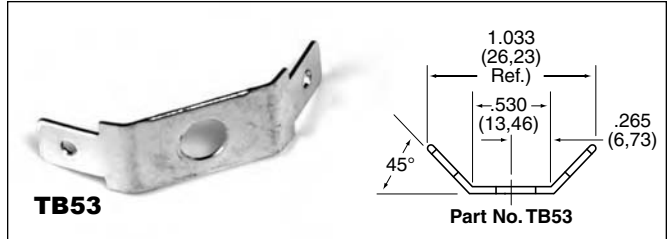

TB53

Technical drawing for Part No. TB53 showing dimensions: 1.033 (26,23) Ref., .530 (13,46), .265 (6,73), 45°.

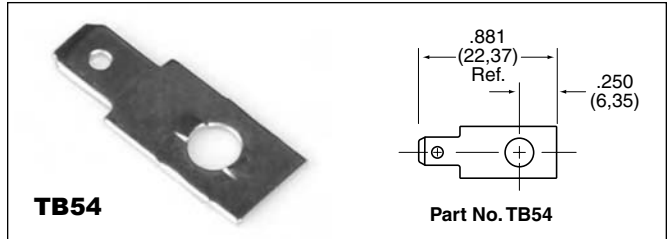

TB54

Technical drawing for Part No. TB54 showing dimensions: .881 (22,37) Ref., .250 (6,35).

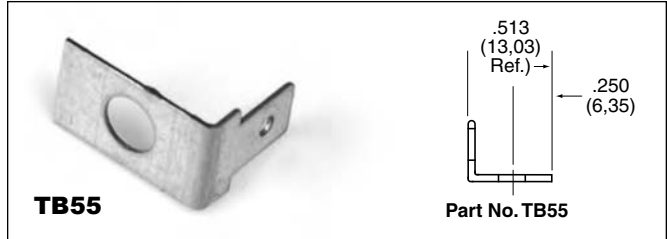

TB55

Technical drawing for Part No. TB55 showing dimensions: .513 (13,03) Ref., .250 (6,35).

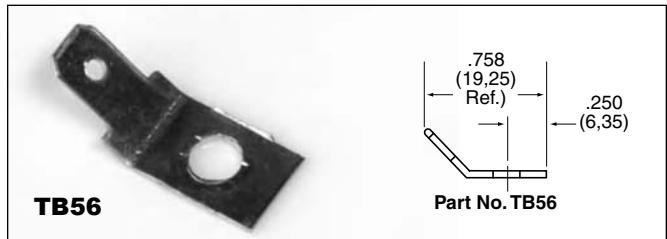

TB56

Technical drawing for Part No. TB56 showing dimensions: .758 (19,25) Ref., .250 (6,35).

TINNERMAN NUTS

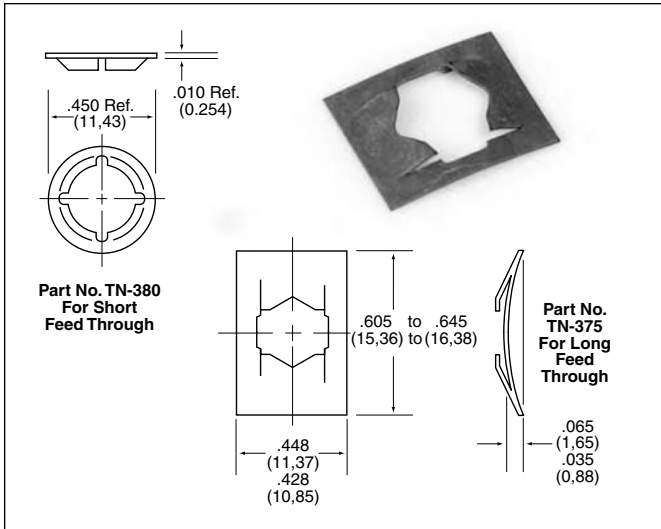

Technical drawings for Part No. TN-380 For Short Feed Through and Part No. TN-375 For Long Feed Through. Dimensions include: .450 Ref. (11,43), .010 Ref. (0,254), .605 to .645 (15,36 to 16,38), .448 (11,37), .428 (10,85), .065 (1,65), .035 (0,88).

COVERS

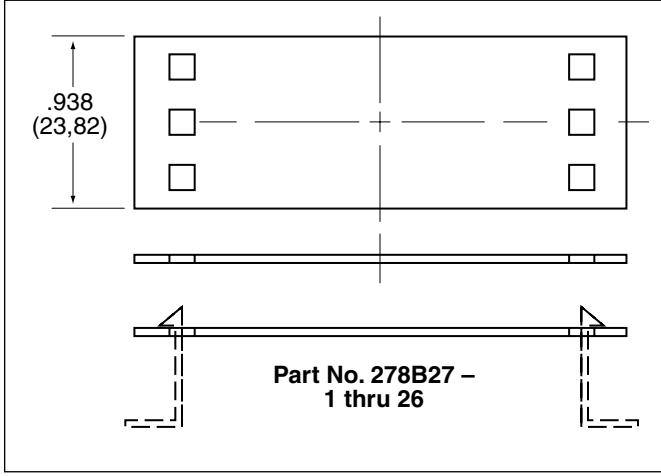

Technical drawing for Part No. 278B27 - 1 thru 26 showing dimensions: .938 (23,82).

Single Row
BARRIER STYLE

Dimensions are in inches and millimeters unless otherwise specified. Values in parentheses are metric equivalents.

Series CB/CFT .375" (7/8") 9.52mm Center-to-Center Spacing

Single Row

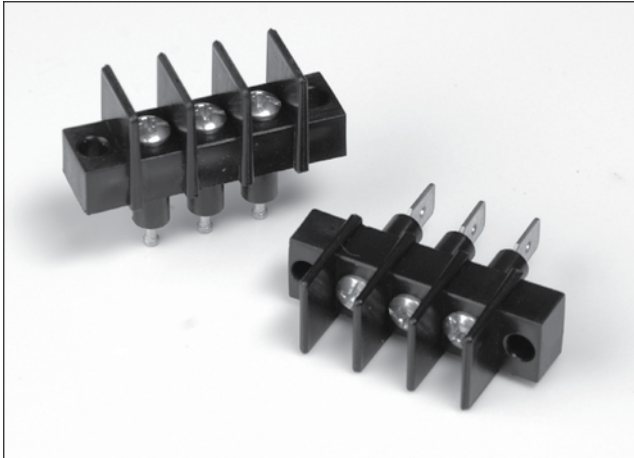
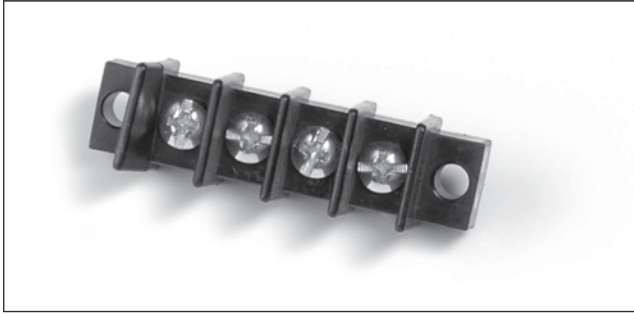

Features:

- **Compact Barrier-Type Design** – Especially suited for electronic and control feed-thru applications where space saving is required
- **Fully Insulated Feed-Thru, Disconnect, Printed Circuit or Surface Connection** – One thru 26 terminals on .375" center-to-center spacing
- **Improved High Barrier-Type Design** – Meets industrial control clearance and creepage requirements set by UL. Rated 20A up to 600V
- **Suitable for High Moisture and Dust Environments** – Blocks are made of break resistance, high-impact black thermoplastic
- **Solid Construction** – Terminals are molded in place with precision screw machined brass inserts which will not twist. Virtually eliminating broken solder joints while providing a full mechanical thread system
- **Broad Wire Range** – No. 6-32 external terminal screw UL recognized for No. 22AWG to No. 12AWG
- **Recognition and Listing** – UL recognized and CSA certified

 Recognized under the Components Program of Underwriters Laboratories, Inc. Standard 1059, Guide No. XCFR2, File No. E62557.

 Guide No. 22.2 No. 158, Report No. LR39186-1. Complies with IEC 947-7-1

BARRIER STYLE

SERIES CB/CFT VARIATIONS

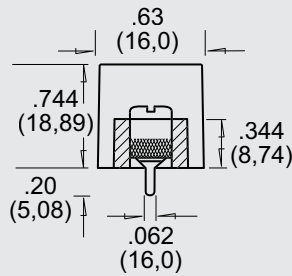

CBP
.062" dia.
printed
circuit pin

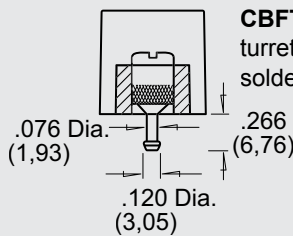

CBFT
turret-type
solder pin

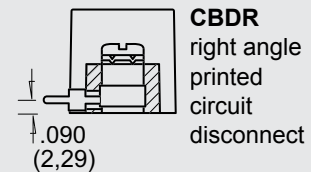

CBDR
right angle
printed
circuit
disconnect

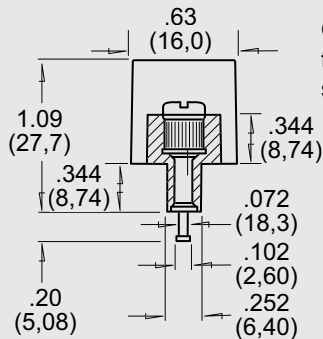

CFT
turret-type
solder pin

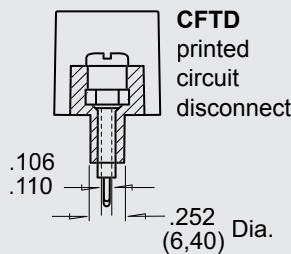

CFTD
printed
circuit
disconnect

CFTD is normally supplied with standard pin installed.

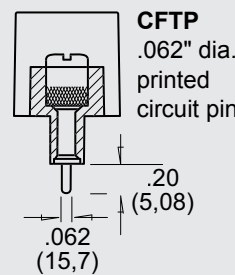

CFTP
.062" dia.
printed
circuit pin

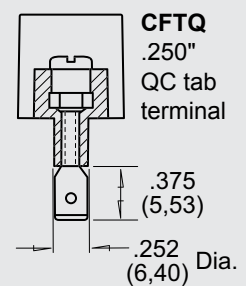

CFTQ
.250"
QC tab
terminal

NOTE: Consult factory for minimums



Specifications:**Center-to-Center Spacing:** .375" (9.52mm)**Wire Range:** No. 22AWG to No. 12AWG**No. of Terminals:** 1 thru 26**Voltage Rating:** CSA – 300V*Screw Terminals:*

UL – 600V – Limited Energy Devices

UL – 300V – General Industrial

Quick Connects:

UL – 125V – General Appliance

Tightening Torque:

Wire Binding Screw 12 in.-lb.

Wire Clamps 20 in.-lb.

Current Rating: 20 amps**Housing:**

Material Thermoplastic Polyester

Continuous Use

Temp. (UL Index) 140°C (284°F)

Flammability Rating 94V-0

Water Absorption

(24 hrs. % wt. gain) .08%

Chemical Resistance Excellent in most environments

Breakdown Voltage:

Terminal - Terminal 7,000V Typ.

Terminal - Ground 6,000V Typ.

Terminals: Solid Brass

Solder style terminals are plated with high-purity tin for optimum solderability

Contact Resistance: .002 Ohm Typ. – CFTD**INTERNAL TERMINAL DESIGNATIONS**

CBP printed circuit board design with .062" diameter tin-plated brass pin

CBFT tin-plated brass turret-type solder pin

CFT tin-plated brass turret-type solder pin

CFTP printed circuit board design with .062" diameter tin-plated brass pin

CFTQ .250" quick connect tab terminal

CFTD disconnect design with factory installed pin terminals for printed circuit mounting

CBDR right angle disconnect design

EXTERNAL TERMINAL DESIGNATIONS

CBP, CBFT, CFT, screw terminal with No. 6-32 plated steel* screw accepting wire up to No. 12AWG

CBPW, CFTW, 6-32 combo head screw with captivated traveling wire clamp
CBFTW, CFTPW,
CFTQW, CFTDW,
CBDRW

* Other materials available – contact factory or your local representative for additional information.

Number of Terminals	Series CB/CFT With Mounting Ends				Without Mounting Ends	
	Dimensions					
	A ± .031 Overall Dimensions (O.D.)		B ± .031 Mounting Dimensions (M.D.)		C ± .031 Less Mounting Positions	
	Inches	Metric (mm)	Inches	Metric (mm)	Inches	Metric (mm)
1	.750	19.05	1.062	26.98	.437	11.11
2	1.125	28.57	1.437	36.51	.812	20.63
3	1.500	38.10	1.812	46.03	1.187	30.16
4	1.875	47.62	2.187	55.56	1.562	39.68
5	2.250	57.15	2.562	65.08	1.937	49.21
6	2.625	66.67	2.937	74.61	2.312	58.73
7	3.000	76.20	3.312	84.13	2.687	68.26
8	3.375	85.72	3.687	93.66	3.062	77.78
9	3.750	95.25	4.062	103.18	3.437	87.31
10	4.125	104.77	4.437	112.71	3.812	96.83
11	4.500	114.30	4.812	122.23	4.187	106.36
12	4.875	123.82	5.187	131.76	4.562	115.88
13	5.250	133.35	5.562	141.28	4.937	125.41
14	5.625	142.87	5.937	150.81	5.312	134.93
15	6.000	152.40	6.312	160.33	5.687	144.46
16	6.375	161.92	6.687	169.86	6.062	153.98
17	6.750	171.45	7.062	179.38	6.437	163.51
18	7.125	180.97	7.437	188.91	6.812	173.03
19	7.500	190.50	7.812	198.43	7.187	182.56
20	7.875	200.02	8.187	207.96	7.562	192.08
21	8.250	209.55	8.562	217.48	7.937	201.61
22	8.625	219.07	8.937	227.01	8.312	211.13
23	9.000	228.60	9.312	236.53	8.687	220.66
24	9.375	238.12	9.687	246.06	9.062	230.18
25	9.750	247.65	10.062	255.58	9.437	239.71
26	10.125	257.17	10.437	265.11	9.812	249.23

Dimensions shown are ± 0.030"

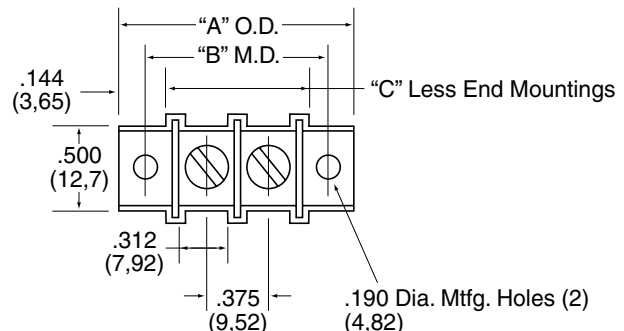
Series CB/CFT Dimensions

How to Order

CFT Series terminal blocks are ordered by listing designation followed by the number of poles required for the application. Example: Type CFT 10-pole block becomes stock number CFT-10.

Suffixes are used as follows:

- W denotes model with wire clamp replacing external screw terminal
- C denotes model less mounting positions

To specify quick-connect terminals, simply add the style number required.

May be purchased factory-assembled or as customer-installed accessory.

The CFT-10 described above with wire clamp less mounting positions thus converts to stock number CFTWC-10.

PC BOARD DRILLING DIMENSIONS

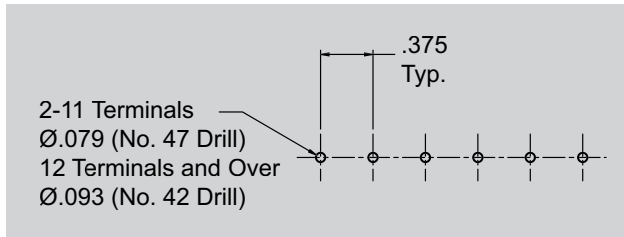

Series CB/CFT Accessories

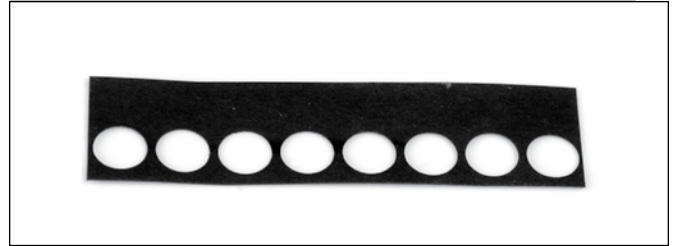

MARKING STRIPS

CB/CFT – Pre-punched black fiber . . . mounts under block. May be imprinted to customer specifications.

To order, specify: Part No. 278A10-1 thru 26 (with mounting hole); Part No. 278A36-1 thru 26 (less mounting hole).

COVERS

CB/CFT – Rigid .030" thick self-extinguishing vinyl. Black matte-finished on both sides. May double as marking strip when imprinted with white ink. Complete with spring clips for attaching to mounting positions.

Part No. 278B27-1 thru 26 terminals

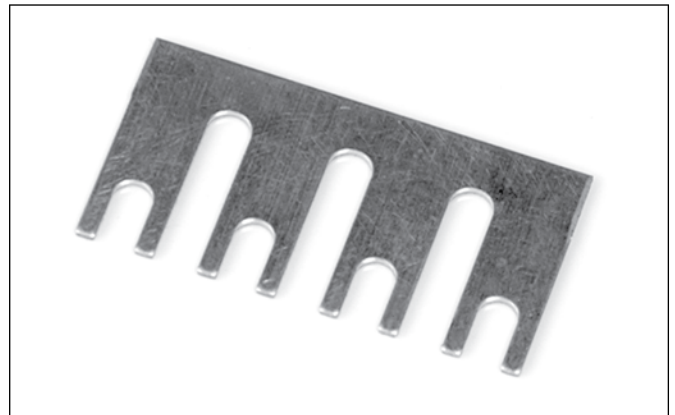

TERMINAL BLOCK JUMPERS

CB/CFT – Jumper is constructed of plated brass. "Rooster comb" design permits connections of two to 10 poles.

To order, specify; Part No. 278-A11 (plus no. of poles)

Example: 278-A11-10, 10 Pole Jumper

WIRE CLAMP

CB/CFT – Wire clamp captivated to No. 6-32 screw eliminates need for lugs. Accepts No. 14AWG wire. Part No. 58523700

Terminal blocks are normally supplied with No. 6-32 combo head screws. Other styles and materials on special order.



QUICK-CONNECT TERMINALS

CB/CFT – Available with .187" x .020" quick-connect tabs of tin-plated brass, held in place by terminal screws. Six styles . . . one to six terminations per pole. Factory-assembled or customer installed. Last digit of part number corresponds to previous style numbers.

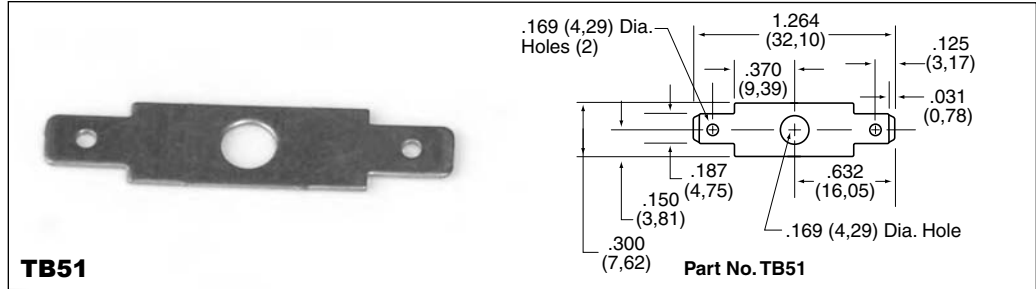

TB51

Part No. TB51

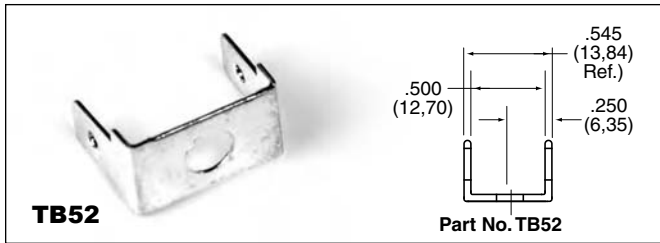

TB52

Part No. TB52

TINNERMAN NUT

CFT – for speed mounting of terminal blocks less mounting position.
Part No. TN-375.

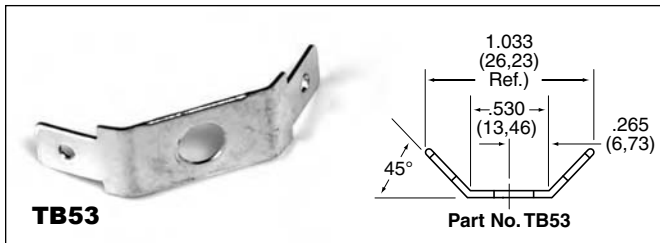
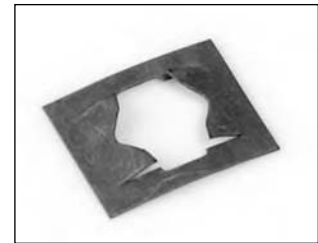

TB53

Part No. TB53

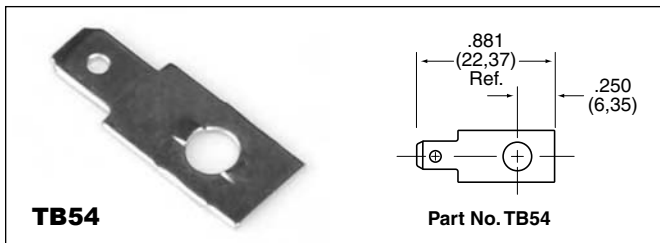

TB54

Part No. TB54

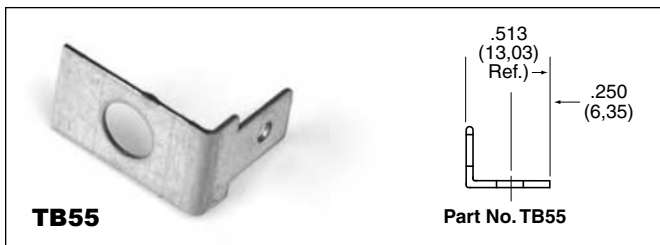

TB55

Part No. TB55

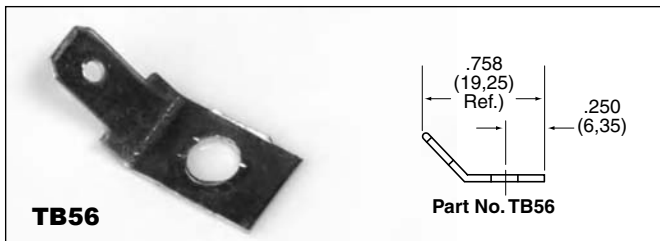

TB56

Part No. TB56

Single Row

BARRIER STYLE



Series 43000 .4375" (11.11mm) Center-to-Center Spacing

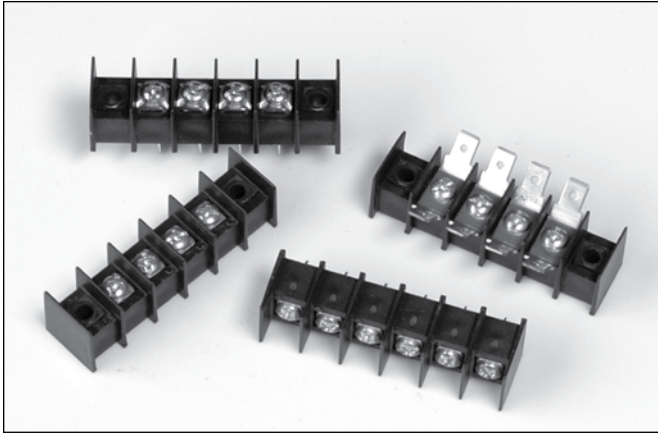

Features:

- Cost-competitive line of .4375" (11.11mm) centerline terminal blocks provides design engineers with multitude of selection choices: base mount and feed thru styles with P.C. pin, turret, quick connect, wire wrap and right angle. Available in up to 28 positions.
- Rated up to 30A, 600V
- Accepts very broad wire range from 22AWG to 12 AWG. Variety to top terminations including 6-32 and 8-32 screws, quick connects, wire clamps, jumpers, and covers.
- Unique Curtis contact design helps eliminate fracturing of solder joint due to pin twist.
- Plated brass inserts are standard on all Series 43000 terminal blocks. Standoffs molded into the blocks inhibit the trapping of solder flux – makes it easier to clean boards.
- All terminal blocks for electronic use are made from highly durable, self-extinguishing polypropylene material rated 94 V-0 by Underwriters Laboratories, Inc.
- Custom built terminal blocks for special applications are available. Contact any authorized Curtis distributor or representative, or call the factory direct.

Single Row



Recognized under the Components Program of Underwriters Laboratories, Inc. Standard 1059, Guide No. XCFR2, File No. E62557.



Guide No. 22.2 No. 158, Report No. LR39186-1.

BARRIER STYLE

Series 43000 Variations

0 – Flush Mount

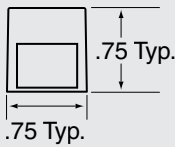

1 – Printed Circuit Pin

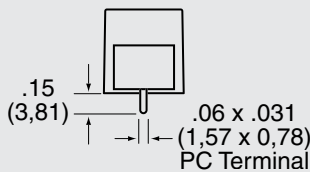

2 – Turret Type Solder Terminal

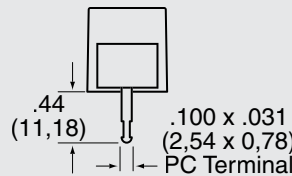

3 – Quick Connect .110"

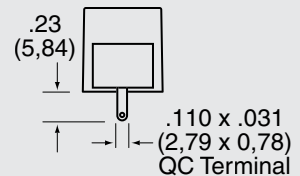

4 – Quick Connect .187"

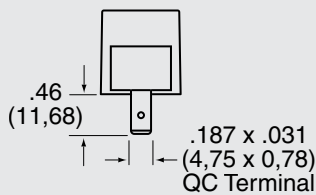

5 – Quick Connect .250"

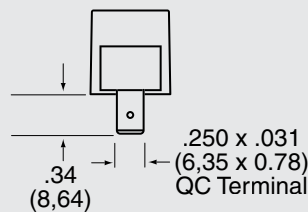

6 – Wire Wrap Pin

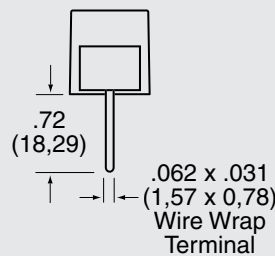

7 – Right Angle Printed Circuit Pin

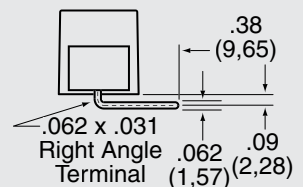

1 – Printed Circuit Pin

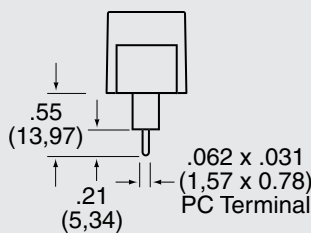

2 – Turret Type Solder Terminal

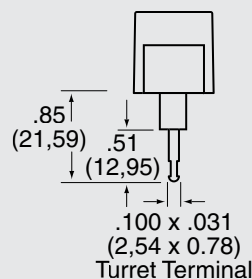

3 – Quick Connect .110"

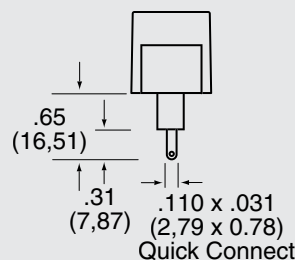

6 – Wire Wrap Pin (extended pc pin)

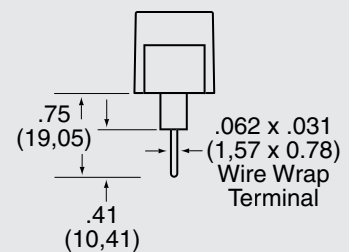

Specifications:

Center-to-Center Spacing: .4375" (11.11mm)

Wire Range: No. 22AWG to 12AWG

No. of Terminals: 1 thru 26 (28 without mounting holes)

Voltage Rating: 600V

Tightening Torque: 9 in. lb.

Current Rating: 20 amps UL
(30 Amps with 10AWG & Lugs)

Housing:

Material Polypropylene
 Continuous Use Temp. (UL Index) 105°C (221°F)
 Flammability Rating 94V-0
 Water Absorption (24 hrs. % wt. gain) .03%

Breakdown Voltage:

Terminal - Terminal 3000V
 Terminal - Ground 3000V

Terminals: Brass - Tin Plated

Series 43000 Surface Mount With Mounting Ends

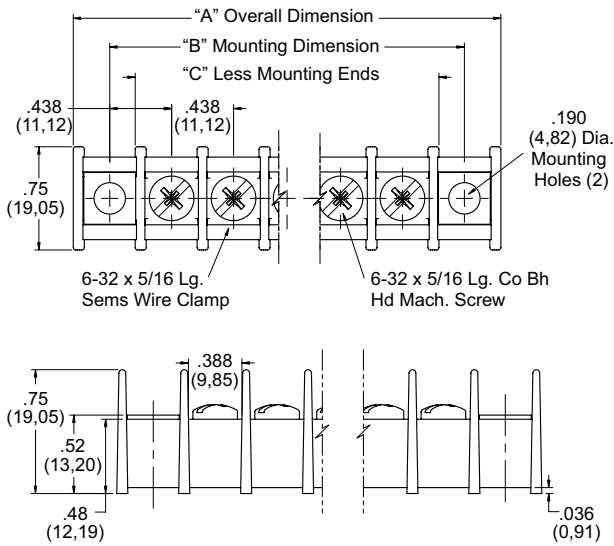

Number of Terminals	Series 43000 With Mounting Ends				Without Mounting Ends	
	Dimensions					
	A ± .031 Overall Dimensions (O.D.)		B ± .031 Mounting Dimensions (M.D.)		C ± .031 Less Mounting Positions	
	Inches	Metric (mm)	Inches	Metric (mm)	Inches	Metric (mm)
1	1.375	34.93	.875	22.23	.500	12.70
2	1.813	46.05	1.313	33.35	.938	23.83
3	2.250	57.15	1.750	44.45	1.375	34.93
4	2.688	68.28	2.188	55.58	1.813	46.05
5	3.125	79.38	2.625	66.68	2.250	57.15
6	3.563	90.50	3.063	77.80	2.688	68.28
7	4.000	101.60	3.500	88.90	3.125	79.38
8	4.438	112.73	3.938	100.03	3.563	90.50
9	4.875	123.83	4.375	111.13	4.000	101.60
10	5.313	134.95	4.813	122.25	4.438	112.73
11	5.750	146.05	5.250	133.35	4.875	123.83
12	6.188	157.18	5.688	144.48	5.313	134.95
13	6.625	168.28	6.125	155.58	5.750	146.05
14	7.063	179.40	6.563	166.70	6.188	157.18
15	7.500	190.50	7.000	177.80	6.625	168.28
16	7.938	201.63	7.438	188.93	7.063	179.40
17	8.375	212.73	7.875	200.03	7.500	190.50
18	8.813	223.85	8.313	211.15	7.938	201.63
19	9.250	235.00	8.750	222.25	8.375	212.73
20	9.688	246.08	9.188	233.38	8.813	223.85
21	10.125	257.18	9.625	244.48	9.250	234.95
22	10.563	268.30	10.063	255.60	9.688	246.08
23	11.000	279.4	10.500	266.70	10.125	257.18
24	11.438	290.53	10.938	277.83	10.563	268.30
25	11.875	301.63	11.375	288.93	11.000	279.40
26	12.313	312.75	11.813	300.05	11.438	290.53
27					11.875	301.63
28					12.313	312.75

Dimensions shown are ± 0.030"

43000 Feed-Thru Series

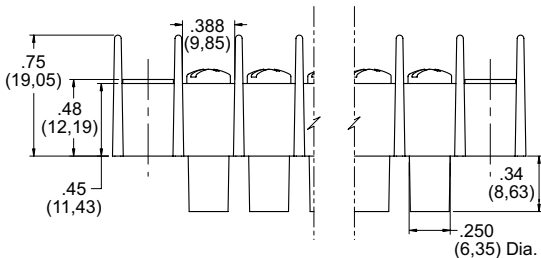

Dimensions are in inches and millimeters unless otherwise specified. Values in parentheses are metric equivalents.



Curtis Industries
A Division of Powers Holdings, Inc.

Series 43000

How to Order

43 X X X X XX X

MOLDING DESIGN

- 0 = Surface Mount w/ Mounting Ends
- 1 = Surface Mount w/o Mounting Ends
- 2 = Insulated Feed Thru w/ Mounting Ends
- 3 = Insulated Feed Thru w/o Mounting Ends

INSERT OR BOTTOM TERMINATION DESIGN

- 0 = Surface Mount, No Bottom Termination
- 1 = Printed Circuit Pin
- 2 = Turret Type Solder Terminal
- 3 = Quick Connect .110"
- 4 = Quick Connect .187"
- 5 = Quick Connect .250"
- 6 = Extended Printed Circuit Pin or Wire Wrap
- 7 = Right Angle Printed Circuit Pin

Note: Option 4 & 5 Only Available on Surface Mount Style Molding

INSERT/SCREW DIMENSION

- 0 = 6-32 Insert and Screw
- 1 = 8-32 Insert and Screw, available on PC Pin, Turret Type Solder Pins, Wire Wrap and Right Angle Versions only

SPECIALS OR OPTIONAL DESIGNS

- 0 = None
- A-Z = Custom Configuration

NUMBER OF POSITIONS

Available 1 thru 26 W/Mounting End
1 thru 28 w/o Mounting Ends

HARDWARE OR TOP TERMINATION DESIGN

- 0 = Standard Zinc Plated Steel Screw, Combo Head
- 1 = Wire Clamp Screw
- 2 = Nickel Plated Brass Screw
- 3 = Stainless Steel Screw
- 5 = Without Screws
- 6 = Quick Connects, Screw Type*
- 8 = Captivated Screw

*See accessories

Single Row

BARRIER STYLE

Series 43000 Accessories

WIRE CLAMP

4300 – Wire clamp captivated to No. 6-32 or 8-32 screw eliminates need for lugs. Accepts up to No. 12AWG wire. May be ordered factory installed or loose.

MARKING STRIPS

4300 – Pre-punched black fiber . . . mounts under block. May be imprinted to customer specifications.
To order, specify: Part No. 267A19-1 thru 26 (with mounting hole); Part No. 267A218-1 thru 28 (less mounting hole).

COVERS

43000 – Rigid .030" thick self-extinguishing vinyl. Black matte-finished on both sides. May double as marking strip when imprinted with white ink. Complete with spring clips for attaching to mounting positions.

Part No. 0196__000, 1 thru 26 poles.

Example: 019605000 would be a 5 pole cover

TINNERMAN NUT

4300 – for special mounting of terminal blocks less mounting position.

Part No. TN-375.

TERMINAL BLOCK JUMPERS

4300 – Plated brass "Rooster comb" design Type 267A42 permits connections of two to 18 poles.

To order, specify; Part No. 267A42-__ .

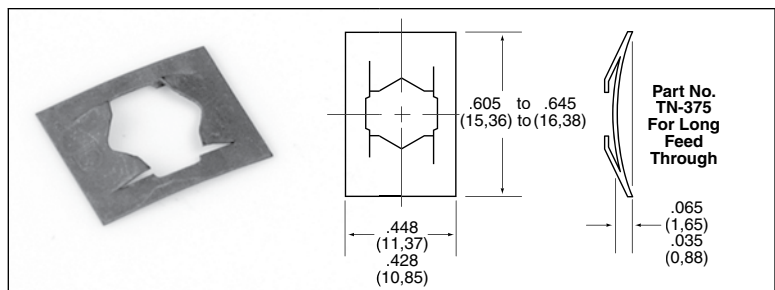
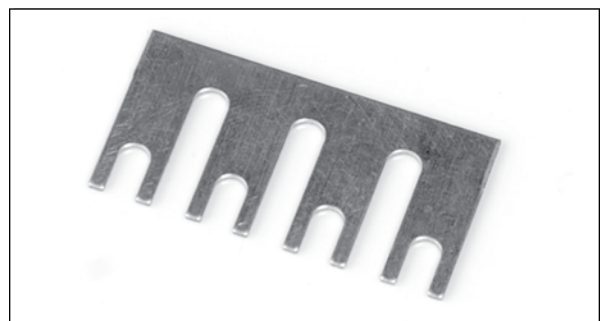

QUICK-CONNECT TERMINALS QUICK-CONNECT TERMINALS

43000 – Available with .250" x .032" quick-connect tabs of tin-plated brass, held in place by terminal screws. Six styles . . . one to six terminations per pole. Factory-assembled or supplied bulk.

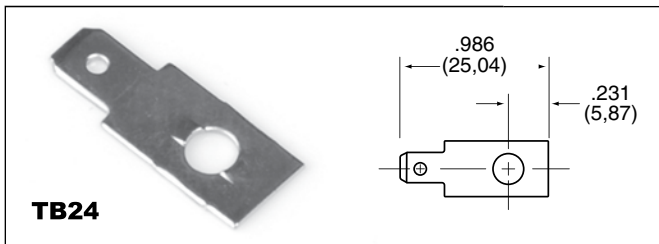
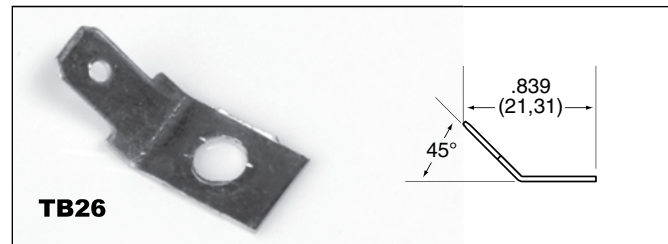
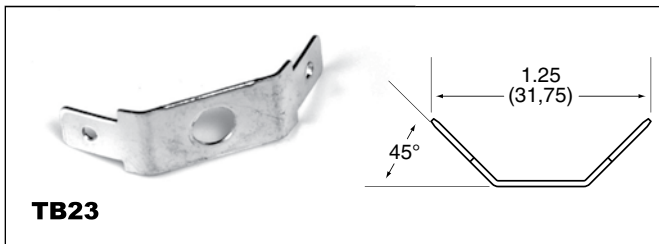
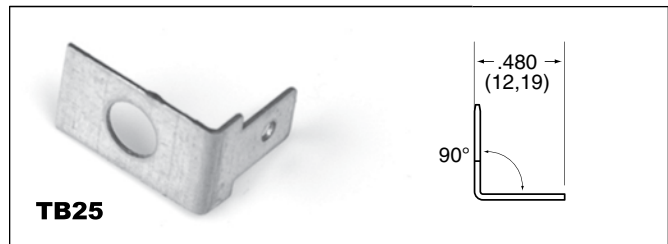
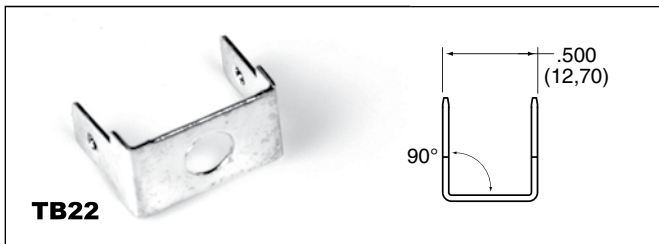
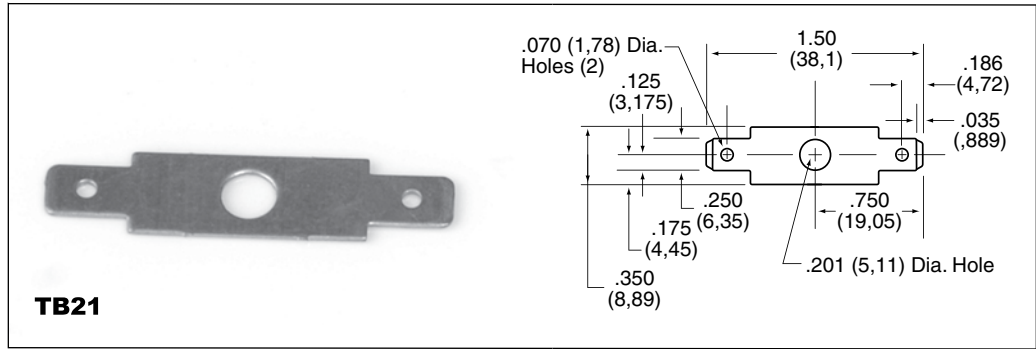

Single Row

BARRIER STYLE

PC BOARD DRILLING DIMENSIONS

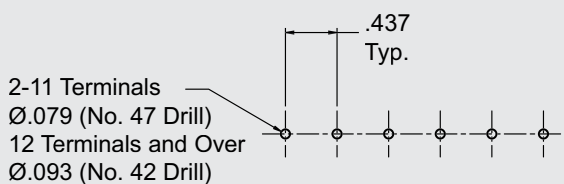

RECOMMENDED PANEL CUTOUT DIMENSIONS

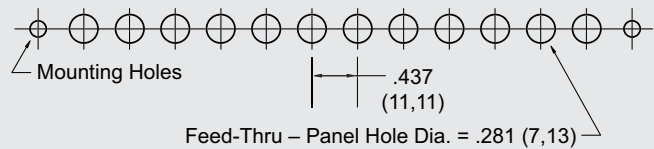

Dimensions are in inches and millimeters unless otherwise specified. Values in parentheses are metric equivalents.



Curtis Industries
A Division of Powers Holdings, Inc.

1-800-657-0853

23