



Chipsmall Limited consists of a professional team with an average of over 10 year of expertise in the distribution of electronic components. Based in Hongkong, we have already established firm and mutual-benefit business relationships with customers from,Europe,America and south Asia,supplying obsolete and hard-to-find components to meet their specific needs.

With the principle of "Quality Parts,Customers Priority,Honest Operation,and Considerate Service",our business mainly focus on the distribution of electronic components. Line cards we deal with include Microchip,ALPS,ROHM,Xilinx,Pulse,ON,Everlight and Freescale. Main products comprise IC,Modules,Potentiometer,IC Socket,Relay,Connector.Our parts cover such applications as commercial,industrial, and automotives areas.

We are looking forward to setting up business relationship with you and hope to provide you with the best service and solution. Let us make a better world for our industry!



Contact us

Tel: +86-755-8981 8866 Fax: +86-755-8427 6832

Email & Skype: info@chipsmall.com Web: www.chipsmall.com

Address: A1208, Overseas Decoration Building, #122 Zhenhua RD., Futian, Shenzhen, China



THIS IS A C.A.D. GENERATED DRAWING
DO NOT MAKE MANUAL REVISIONS TO MASTER.

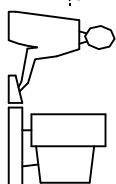

ISSUE NUMBER
REMOVE P/N: 690-009-221-900 R.STAMONICA MAY.07/10
ADD P/N: 690-009-521-900 AND 690-009-621-900 R.STAMONICA JUN.01/10
690-009-521-901 WAS 690-009-521-900 AND 690-009-621-901 WAS 690-009-621-900. ADD TAPE & REEL AND PCB TOLERANCE R.STAMONICA JUN.07/10

ELECTRICAL SPECIFICATIONS:

CURRENT RATING: 1 AMP .30VAC
CONTACT RESISTANCE: 30 MILLIOHMS MAX.
INSULATION RESISTANCE: 1000 MEGOHMS MIN.
DWV: 500VAC
TEMPERATURE RATING: -50°C TO +105°C

MATERIALS:

HOUSING AND COVER: PBT 30%G.F. UL94V-0 COLOR BLACK
CONTACTS: COPPER ALLOY, PLATED WITH 15 MICRONS OF GOLD
ON CONTACT AREA, TIN ON TAILS OVER NICKEL
SHELL: BRASS, NICKEL PLATED
COVER SHELL: COPPER ALLOY, NICKEL PLATED

PC BOARD MOUNTING DIMENSIONS

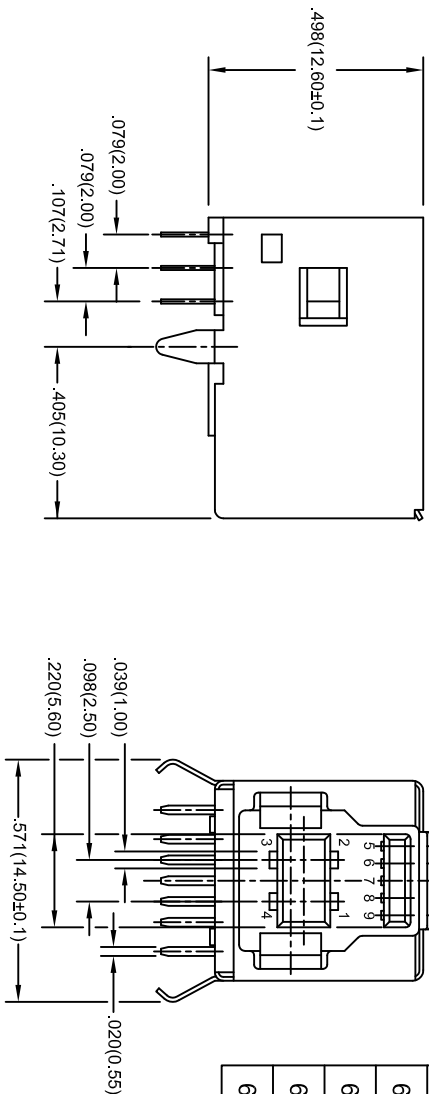
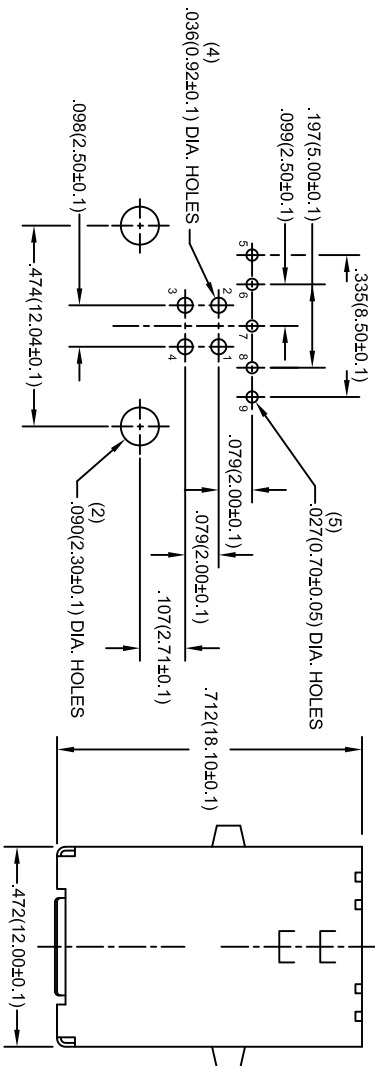

PART NUMBERS	GOLD PLATING	PACKAGING DETAIL
690-009-521-900	15 u" OF GOLD	TAPE AND REEL
690-009-521-901	15 u" OF GOLD	PLASTIC TRAY
690-009-621-900	30 u" OF GOLD	TAPE AND REEL
690-009-621-901	30 u" OF GOLD	PLASTIC TRAY



THIS SERIES FULLY CONFORMS TO THE
EUROPEAN UNION DIRECTIVES 2002/95/EC
AND 2002/96/EC FOR ROHS COMPLIANCY.

USB-B RECEPTACLE 90° DIP, 3.0 VERSION

ACAD REFERENCE NO.	690-009-521-900
DRAWN: F. BRIONES	DATE: AUG.17/09
PART NUMBER	SEE ABOVE
DRAWING NUMBER	690-009-521-900

EDAC INC
TORONTO, ONTARIO
CANADA

YOUR CONNECTION TO QUALITY & SERVICE

THESE DRAWINGS AND SPECIFICATIONS ARE THE PROPERTY OF EDAC INC. AND SHALL NOT BE REPRODUCED, OR COPIED OR USED AS THE BASIS FOR THE MANUFACTURE OR SALE OF APPARATUS WITHOUT WRITTEN PERMISSION.

SHEET 1 OF 3
ISSUE
8

THIS IS A C.A.D. GENERATED DRAWING
DO NOT MAKE MANUAL REVISIONS TO MASTER.

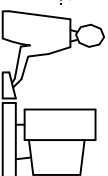

ISSUE NUMBER

SEE PAGE 1 OF 3

8

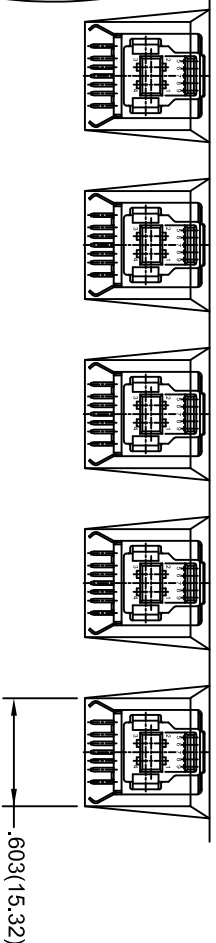
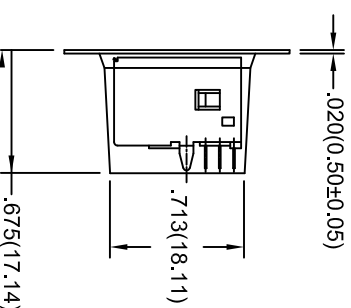
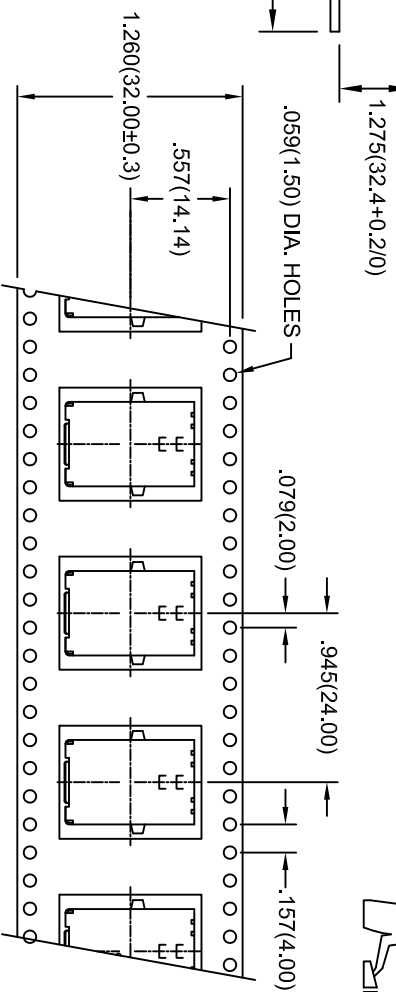
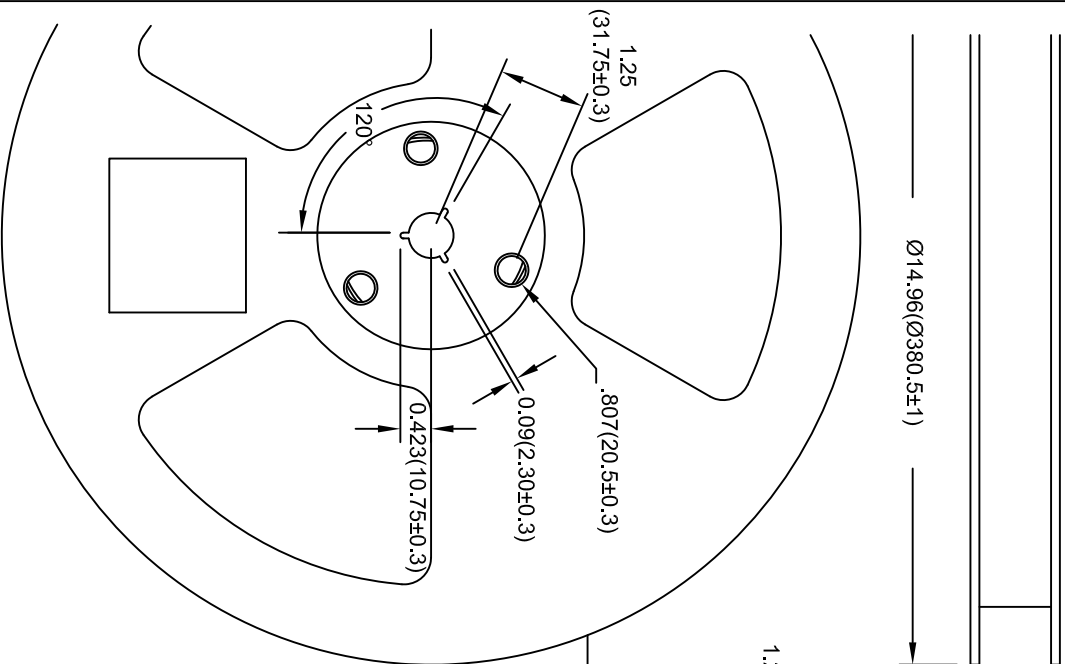

NOTE:
TOLERANCE FOR ALL DIMENSIONS IN MM IS ±0.1, UNLESS OTHERWISE SPECIFIED

**USB-B RECEPTACLE 90° DIP, 3.0 VERSION
PACKAGING REEL (200 PCS PER REEL)**

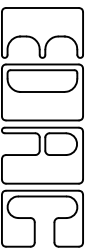

EDAC INC
TORONTO, ONTARIO
CANADA
YOUR CONNECTION TO QUALITY & SERVICE

THESE DRAWINGS AND SPECIFICATIONS
ARE THE PROPERTY OF EDAC INC. AND
SHALL NOT BE REPRODUCED, OR COPIED
OR USED AS THE BASIS FOR THE
MANUFACTURE OR SALE OF APPARATUS
WITHOUT WRITTEN PERMISSION.

ACAD REFERENCE NO. 690-009-521-013

DRAWN: F. BRIONES DATE: AUG. 17/09

PART NUMBER

SEE PAGE 1 OF 3

SHEET 2 OF 3

DRAWING NUMBER

690-009-521-900

ISSUE

8

THIS IS A C.A.D. GENERATED DRAWING
DO NOT MAKE MANUAL REVISIONS TO MASTER.

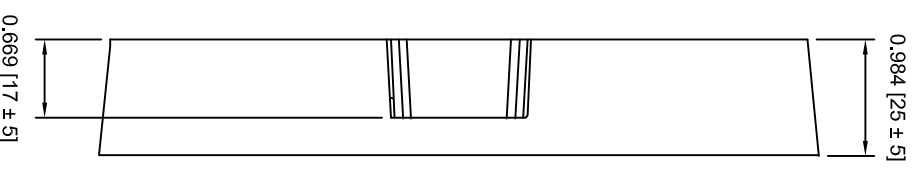
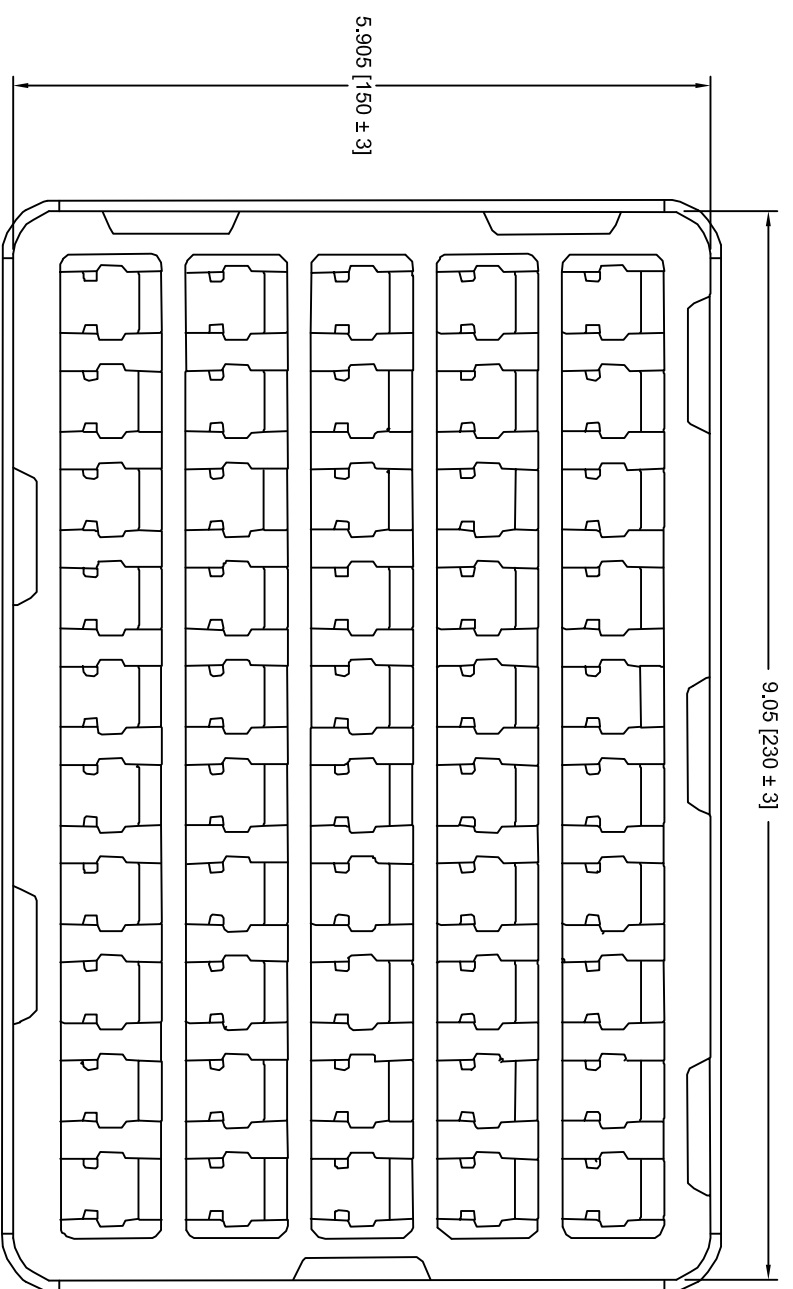
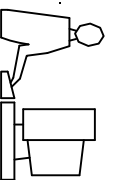

- NOTES:
- 1. MATERIAL: TRANSPARENT PVC
 - 2. THICKNESS: 0.20 ± 0.05MM
 - 3. PCS / TRAY : 50PCS
 - 4. TRAY / BOX : 30TRAYS
 - 5. PCS / BOX : 1500PCS
 - 6. CARTON SIZE:
480MM x 250MM x 200MM

**USB-B RECEPTACLE 90° DIP, 3.0 VERSION
TRAY PACKAGING (50 PCS PER TRAY)**

EDAC INC
TORONTO, ONTARIO
CANADA
YOUR CONNECTION TO QUALITY & SERVICE

THESE DRAWINGS AND SPECIFICATIONS
ARE THE PROPERTY OF EDAC INC., AND
SHALL NOT BE REPRODUCED, OR COPIED
OR USED AS THE BASIS FOR THE
MANUFACTURE OR SALE OF APPARATUS
WITHOUT WRITTEN PERMISSION.

ACAD REFERENCE NO.	690-009-521-013
DRAWN: R.STA. MONICA	DATE: JUN.01/10
PART NUMBER	SEE PAGE 1 OF 3
DRAWING NUMBER	690-009-521-900
	SHEET 3 OF 3
	ISSUE
	8