



Chipsmall Limited consists of a professional team with an average of over 10 year of expertise in the distribution of electronic components. Based in Hongkong, we have already established firm and mutual-benefit business relationships with customers from,Europe,America and south Asia,supplying obsolete and hard-to-find components to meet their specific needs.

With the principle of "Quality Parts,Customers Priority,Honest Operation,and Considerate Service",our business mainly focus on the distribution of electronic components. Line cards we deal with include Microchip,ALPS,ROHM,Xilinx,Pulse,ON,Everlight and Freescale. Main products comprise IC,Modules,Potentiometer,IC Socket,Relay,Connector.Our parts cover such applications as commercial,industrial, and automotives areas.

We are looking forward to setting up business relationship with you and hope to provide you with the best service and solution. Let us make a better world for our industry!



Contact us

Tel: +86-755-8981 8866 Fax: +86-755-8427 6832

Email & Skype: info@chipsmall.com Web: www.chipsmall.com

Address: A1208, Overseas Decoration Building, #122 Zhenhua RD., Futian, Shenzhen, China



Model 73004
MCX PLUG STRAIGHT CRIMP, RG179

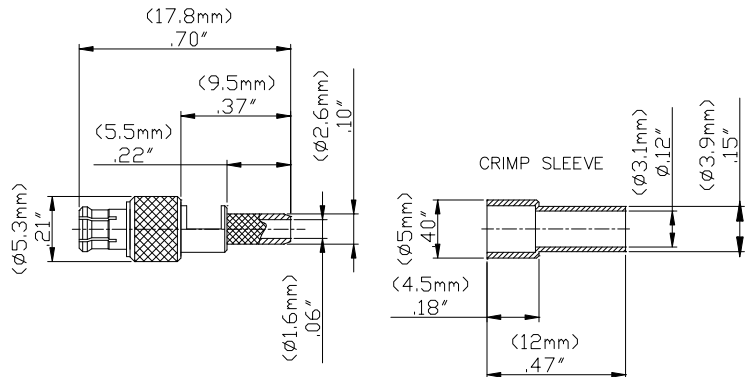

Model 73004 MCX PLUG STRAIGHT CRIMP, RG179

Snap-on coupling and miniature size for fast connect and disconnect where space is limited.

Features

- DC - 2 GHz bandwidth.
- 30% smaller than SMB connectors.
- Meets CECC 22220.
- Perfect for applications where space, weight, performance and ease of assembly are required.
- Precision machined and gold-plated for low loss.

Materials

- Body is machined brass with gold plating.
- Center contacts – Plug is gold plated brass and Jack is gold plated beryllium copper.
- High quality PTFE insulators.
- Crimp Ferrules are gold or nickel plated copper.

Specifications

Impedance	75 Ω
Frequency Range	DC - 2 GHz
VSWR	1.35 max.
Working Voltage	170 Vrms
Dielectric withstand voltage	750 Vrms
Center / Outer contact resistance	5 / 2.5 m Ω
Number of insertions	500 cycles min.
Insulation resistance	1,000 M Ω min.
Temperature Range	-55° C to 155° C, -67° F to 311° F

Ordering Information

Model: 73004

Description: MCX PLUG STRAIGHT CRIMP, RG179

USA: Sales: 800-490-2361

Technical Support: technicalsupport@pomonatest.com

Fax: 425-446-5844

Europe: 31-(0) 40 2675 150 International: 425-446-5500

Where to Buy: www.pomonaelectronics.com

All dimensions are in inches. Tolerances (except noted): .xx = $\pm .02$ " (.51 mm), .xxx = $\pm .005$ " (.127 mm). All specifications are to the latest revisions. Specifications are subject to change without notice. Registered trademarks are the property of their respective companies.
D2003441 REV 001

**Model 73004
MCX PLUG STRAIGHT CRIMP, RG179**

Cable Types and Crimp Die Information

Connector Model #	Cable Groups	Crimp Die Cavity Size for Outer Ferrule
73004	RG179	.128 (3.3)

Cable Assembly Instructions

1. CUT CABLE END EVENLY AND PERPENDICULAR.

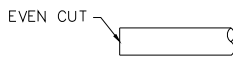

2. SLIDE OUTER FERRULE OVER CABLE END.

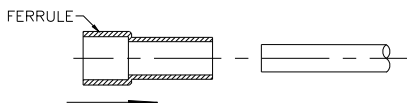

3. STRIP CABLE JACKET, BRAID, AND DIELECTRIC TO SPECIFICATION LENGTHS.

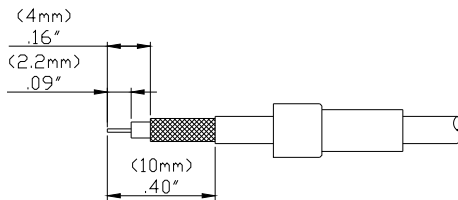

RECOMMENDED STRIP LENGTHS

4. FLARE BRAID END SLIGHTLY.

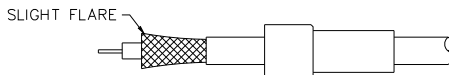

5. SLIDE CONNECTOR BODY OVER CENTER CONDUCTOR, DIELECTRIC AND UNDER BRAID.

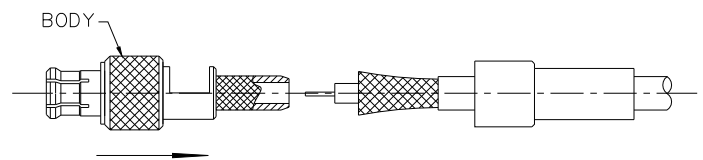

6. SLIDE OUTER FERRULE OVER BRAID AND UP AGAINST BODY ASSEMBLY.

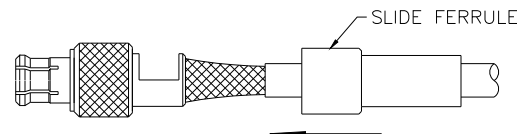

7. CRIMP OUTER FERRULE WITH APPROPRIATE CRIMP TOOL.

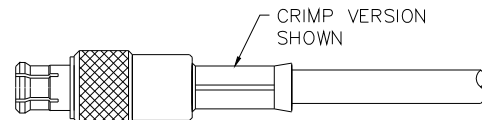

USA: Sales: 800-490-2361
 Technical Support: technicalsupport@pomonatest.com
 Fax: 425-446-5844
Europe: 31-(0) 40 2675 150 **International:** 425-446-5500
Where to Buy: www.pomonaelectronics.com

All dimensions are in inches. Tolerances (except noted): .xx = ±.02" (.51 mm), .xxx = ±.005" (.127 mm). All specifications are to the latest revisions. Specifications are subject to change without notice. Registered trademarks are the property of their respective companies.
 D2003441 REV 001