



Chipsmall Limited consists of a professional team with an average of over 10 year of expertise in the distribution of electronic components. Based in Hongkong, we have already established firm and mutual-benefit business relationships with customers from,Europe,America and south Asia,supplying obsolete and hard-to-find components to meet their specific needs.

With the principle of “Quality Parts,Customers Priority,Honest Operation,and Considerate Service”,our business mainly focus on the distribution of electronic components. Line cards we deal with include Microchip,ALPS,ROHM,Xilinx,Pulse,ON,Everlight and Freescale. Main products comprise IC,Modules,Potentiometer,IC Socket,Relay,Connector.Our parts cover such applications as commercial,industrial, and automotives areas.

We are looking forward to setting up business relationship with you and hope to provide you with the best service and solution. Let us make a better world for our industry!



Contact us

Tel: +86-755-8981 8866 Fax: +86-755-8427 6832

Email & Skype: info@chipsmall.com Web: www.chipsmall.com

Address: A1208, Overseas Decoration Building, #122 Zhenhua RD., Futian, Shenzhen, China



DESCRIPTION : ABOVE PCB/BELOW PCB, DECK AND PUSH ROD LOCATION ARE AS VIEW BY USER.

PRODUCT NO.	PUSH ROD LOCATION	STAND-OFF HEIGHT	MATING RECEPTACLE	P.C.B SIDE	RECOMMENDED P.C.B LAYOUT	MOUNT STYLE TO PCB AND PUSH ROD SIDE
(A) 74054-*****			(B)			
000CAS	RIGHT	0.0	100 POSITIONS (2x50) 0.8mm RECEPTACLE PART NO. 73277-101402LF	ABOVE	SEE DRAWING NO.: TA-1050	
020CAS	RIGHT	2.0				
022CAS	RIGHT	2.2				
028CAS	RIGHT	2.8				
040CAS	RIGHT	4.0				
043CAS	RIGHT	4.3				
050CAS	RIGHT	5.0				
100CAS	LEFT	0.0				
120CAS	LEFT	2.0				
122CAS	LEFT	2.2				
128CAS	LEFT	2.8				
140CAS	LEFT	4.0				
143CAS	LEFT	4.3				
150CAS	LEFT	5.0				
022CAR	RIGHT	2.2				
122CAT	LEFT	2.2				
522CAS	RIGHT	2.2				
540CAS	RIGHT	4.0				
543CAS	RIGHT	4.3				
550CAS	RIGHT	5.0				
622CAS	LEFT	2.2				
640CAS	LEFT	4.0				
643CAS	LEFT	4.3				
650CAS	LEFT	5.0				

2-STEP CARDBUS WITH METAL COVER						
322CAS	LEFT	2.2	100 POSITIONS (2x50) 0.8mm RECEPTACLE PART NO.	ABOVE	SEE DRAWING NO.: TA-1050	

2-STEP CARDBUS WITH SPECIAL PUSH ROD						
740CAS-B	LEFT PUSH ROD COLOR :BLACK	4.0	100 POSITIONS (2x50) 0.8mm RECEPTACLE PART NO.	BELOW	SEE DRAWING NO.: TA-1050	
840CAS	RIGHT PUSH ROD COLOR :BLACK	4.0	100 POSITIONS (2x50) 0.8mm RECEPTACLE PART NO.	BELOW	SEE DRAWING NO.: TA-1050	
740CAS-BLF	LEFT PUSH ROD COLOR :BLACK (Lead-Free type)	4.0	100 POSITIONS (2x50) 0.8mm RECEPTACLE PART NO.	BELOW	SEE DRAWING NO.: TA-1050	
840CASLF	RIGHT PUSH ROD COLOR :BLACK (Lead-Free type)	4.0	100 POSITIONS (2x50) 0.8mm RECEPTACLE PART NO.	BELOW	SEE DRAWING NO.: TA-1050	

NOTES:

- 8.0mm MIN CARD EJECT.
- EJECT TRAVEL: 9.50mm
- MATERIAL:
 - 3.1 EJECT HEADER ASS'Y
 - PLASTIC HOUSING: HIGH TEMPERATURE THERMOPLASTIC UL94V-0 BLACK
 - PIN: COPPER ALLOY
 - PCB: FR4
 - PLASTIC GUIDE: HIGH TEMPERATURE THERMOPLASTIC UL94V-0 BLACK
 - PLATE: STAINLESS
 - EMI CONTACT: PHOSPHOR BRONZE
 - 3.2 RECEPTACLE
 - PLASTIC: HIGH TEMPERATURE THERMOPLASTIC UL94V-0 BLACK
 - PIN: BeCu
- FINISH
 - PIN :(FOR OTHER VERSIONS)
 - UNDER PLATING: 0.5um MIN. Ni
 - CONTACT AREA: 0.076 μm MIN. GOLD
 - PIN :(FOR LEAD-FREE TYPE)
 - UNDER PLATING: 1.27um MIN. Ni
 - CONTACT AREA: 0.076 μm MIN. GOLD
 - SOLDER TAIL: 2.5um MIN. PURE Tin.
 - GROUND SHIELD :
 - UNDER PLATING: 0.75um MIN. Ni
 - CONTACT SURFACE: 0.03um GOLD MIN. OVER PdNi 0.5um MIN.(GOLD FLASH DOUBLE SIDES) OR, 0.38um GOLD(ONE SIDE ONLY)
- PUSH ROD LOCATION AND P.C.B. ARE AS APPEARS INSTALLED
- DIM "X"

4.25±0.1	3.5±0.1	5.0±0.1
OTHERS	36,67	1,17,34,35,51,68
- DO NOT TOUCH AND KEEP CLEAN THE SURFACES OF PCB OF HEADER ASS'Y.
- P.C.B LAYOUT AND PIN ASSIGNMENT REFERED TO PART NUMBER TA-1050.
- PRODUCT SPEC:110-263

ORDERING INFORMATION

THREADED INSERT ASSEMBLED BY BERG		
NAME	PART NO.	Q'TY
(A) EJECT HEADER ASS'Y	74054-*****	1
(B) MATING RECEPTACLE	73277-101402LF	1

mat'l. code	surface	tolerance	projection	product family
	ISO 1302	ISO 406 ISO 1101		CARDBUS SINGLE DECK
ltr ecn no dr date	tolerances unless otherwise specified			2-STEP, TYPE 1/2/3
S N05-0087 WB 06/17/05	angles	linear ± 0.30	MM	dwg no 74054
T N05-0175 WB 03/23/05				sheet 1 of 10 size A4
U N08-0028 MZ 02/22/08	±2'		scale	type CUSTOMER Drawing
V ELX-N-011416 ZK 04/07/12	dr WENDY CHEN	09/23/97		
	engr STELAR CHU	09/23/97		
	chr JOSEPH HSIA	09/23/97		
	app JENN TSAO	09/23/97		
sheet revision	V V V V V V V V V V			
index sheet	1 2 3 4 5 6 7 8 9 10			

FCI CONFIDENTIAL

FCI

This document is the property of and embodies CONFIDENTIAL and PROPRIETARY information of FCI. No part of this information shown on this document may be used in any way or disclosed to others without the written consent of FCI. Copyright FCI.

DESCRIPTION : ABOVE PCB/BELOW PCB, DECK AND PUSH ROD LOCATION ARE AS VIEW BY USER.

PRODUCT NO.	PUSH ROD LOCATION	STAND-OFF HEIGHT	MATING RECEPTACLE (B)	P.C.B SIDE	RECOMMENDED P.C.B LAYOUT	MOUNT STYLE TO PCB AND PUSH ROD SIDE			
(A) 74054-*****									
000CASLF	RIGHT	0.0	100 POSITIONS (2x50) 0.8mm RECEPTACLE PART NO. 73277-101402LF	ABOVE	SEE DRAWING NO.: TA-1050				
020CASLF	RIGHT	2.0							
022CASLF	RIGHT	2.2							
028CASLF	RIGHT	2.8							
040CASLF	RIGHT	4.0							
043CASLF	RIGHT	4.3							
050CASLF	RIGHT	5.0							
100CASLF	LEFT	0.0							
120CASLF	LEFT	2.0							
122CASLF	LEFT	2.2							
128CASLF	LEFT	2.8							
140CASLF	LEFT	4.0							
143CASLF	LEFT	4.3							
150CASLF	LEFT	5.0							
022CARLF	RIGHT	2.2				100 POSITIONS (2x50) 0.8mm RECEPTACLE PART NO. 73277-101402LF	BELOW	SEE DRAWING NO.: TA-1050	
122CATLF	LEFT	2.2							
522CASLF	RIGHT	2.2							
540CASLF	RIGHT	4.0							
543CASLF	RIGHT	4.3							
550CASLF	RIGHT	5.0							
622CASLF	LEFT	2.2							
640CASLF	LEFT	4.0							
643CASLF	LEFT	4.3							
650CASLF	LEFT	5.0							
322CASLF	LEFT	2.2	100 POSITIONS (2x50) 0.8mm RECEPTACLE PART NO.	ABOVE	SEE DRAWING NO.: TA-1050				 (WITH METAL SHIELD)
740CAS-B	LEFT PUSH ROD COLOR :BLACK	4.0	100 POSITIONS (2x50) 0.8mm RECEPTACLE PART NO.	BELOW	SEE DRAWING NO.: TA-1050				
840CAS	RIGHT PUSH ROD COLOR :BLACK	4.0	100 POSITIONS (2x50) 0.8mm RECEPTACLE PART NO.	BELOW	SEE DRAWING NO.: TA-1050				
740CAS-BLF	LEFT PUSH ROD COLOR :BLACK (Lead-Free type)	4.0	100 POSITIONS (2x50) 0.8mm RECEPTACLE PART NO.	BELOW	SEE DRAWING NO.: TA-1050				
840CASLF	RIGHT PUSH ROD COLOR :BLACK (Lead-Free type)	4.0	100 POSITIONS (2x50) 0.8mm RECEPTACLE PART NO.	BELOW	SEE DRAWING NO.: TA-1050				

2-STEP CARDBUS WITH METAL COVER

2-STEP CARDBUS WITH SPECIAL PUSH ROD

NOTES:

- 8.0mm MIN CARD EJECT.
- EJECT TRAVEL: 9.50mm
- MATERIAL:
 - EJECT HEADER ASS'Y
 - PLASTIC HOUSING: HIGH TEMPERATURE THERMOPLASTIC UL94V-0 BLACK
 - PIN: COPPER ALLOY
 - PCB: FR4
 - PLASTIC GUIDE: HIGH TEMPERATURE THERMOPLASTIC UL94V-0 BLACK
 - PLATE: STAINLESS
 - EMI CONTACT: PHOSPHOR BRONZE
 - RECEPTACLE
 - PLASTIC: HIGH TEMPERATURE THERMOPLASTIC UL94V-0 BLACK
 - PIN: BeCu
- FINISH
 - PIN :(FOR OTHER VERSIONS)
 - UNDER PLATING: 0.5um MIN. Ni
 - CONTACT AREA: 0.076 μm MIN. GOLD
 - PIN :(FOR LEAD-FREE TYPE)
 - UNDER PLATING: 1.27um MIN. Ni
 - CONTACT AREA: 0.076 μm MIN. GOLD
- PUSH ROD LOCATION AND P.C.B. ARE AS APPEARS INSTALLED
- DIM "X"

4.25±0.1	3.5±0.1	5.0±0.1
OTHERS	36,67	1,17,34,35,51,68
- DO NOT TOUCH AND KEEP CLEAN THE SURFACES OF PCB OF HEADER ASS'Y.
- P.C.B LAYOUT AND PIN ASSIGNMENT REFERED TO PART NUMBER TA-1050.
- IF LEAD FREE P.N.THE HOUSING WILL WITHSTAND EXPOSURE TO 260°C PEAK TEMPERATURE FOR 10 SECONDS IN A WAVE SOLDER APPLICATION WITH A 1.00MM MINIMUM THICK CIRCUIT BOARD.
- IF LEAD FREE P/N.THE PRODUCT MEETS EUROPEAN UNION DIRECTIVES AND OTHER COUNTRY REGULATIONS AS DISCRIBLED IN GS-22-008
- LEAD FREE P/N PACKAGING MEETS GS-14-920 SPECIFICATION
- PRODUCT SPEC:110-263

ORDERING INFORMATION

THREADED INSERT ASSEMBLED BY BERG		
NAME	PART NO.	Q'TY
(A) EJECT HEADER ASS'Y	74054-*****LF	1
(B) MATING RECEPTACLE	73277-101402LF	1

mat'l. code	surface ISO 1302	tolerance ISO 406 ISO 1181	projection 1:1	product family
ltr ecn nodr date	tolerances unless otherwise specified		title	
v	angles ±2'	linear ± 0.30	MM	CARDBUS SINGLE DECK 2-STEP, TYPE 1/2/3
	dr WENDY CHEN 09/23/97	engr STELAR CHU 09/23/97	chr JOSEPH HSIA 09/23/97	dwg no 74054 sheet 2 of 0 size A4
	app JENN TSAO 09/23/97	type CUSTOMER Drawing		
sheet index	revision sheet			

FCI CONFIDENTIAL

FCI CONFIDENTIAL

FCI CONFIDENTIAL

FCI CONFIDENTIAL

This document is the property of and embodies CONFIDENTIAL and PROPRIETARY information of FCI. No part of this information shown on this document may be used in any way or disclosed to others without the written consent of FCI. Copyright FCI.

FCI CONFIDENTIAL



This document is the property of and embodies CONFIDENTIAL and PROPRIETARY information of FCI. No part of this information shown on this document may be used in any way or disclosed to others without the written consent of FCI.
Copyright FCI.

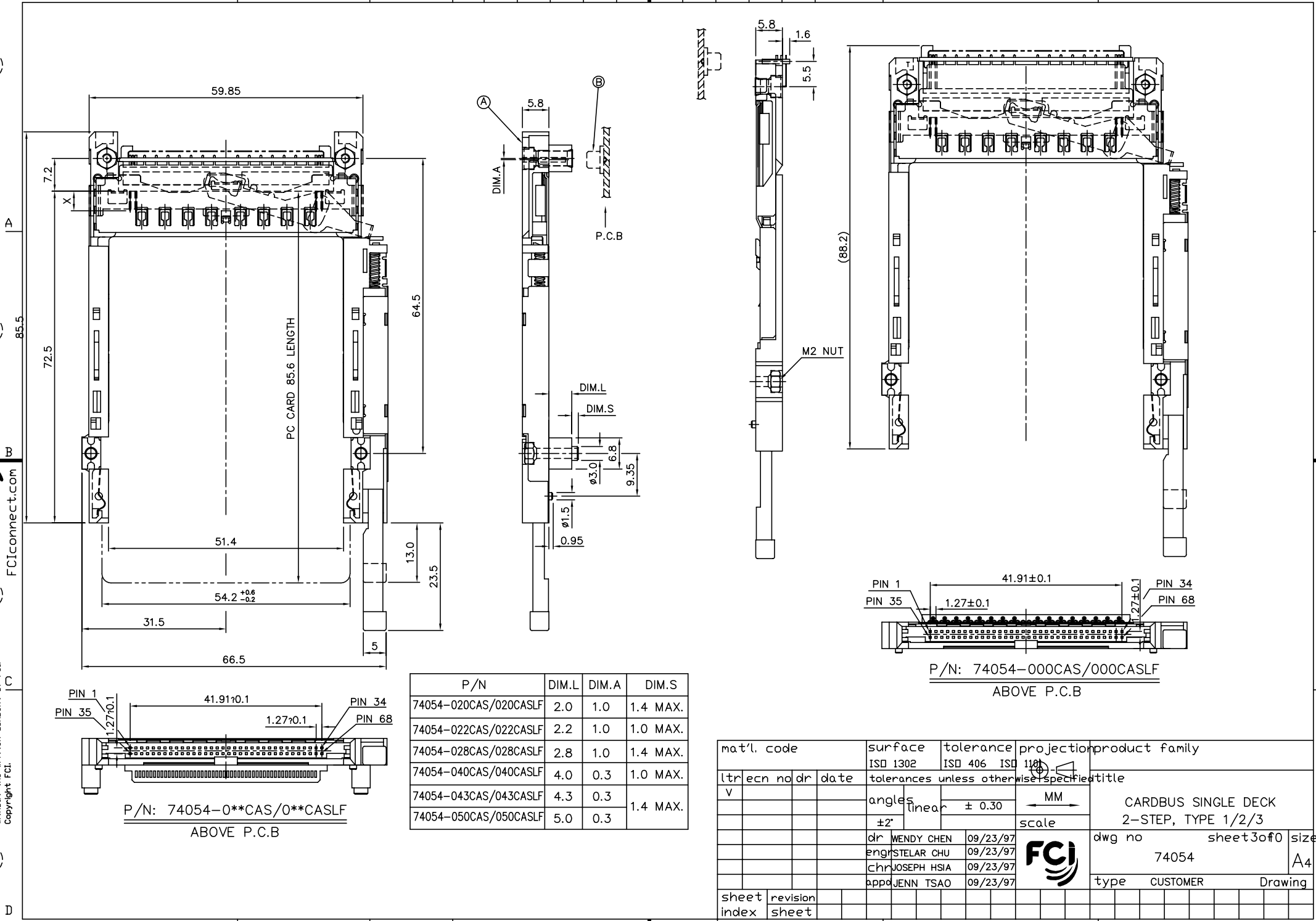

P/N	DIM.L	DIM.A	DIM.S
74054-020CAS/020CASLF	2.0	1.0	1.4 MAX.
74054-022CAS/022CASLF	2.2	1.0	1.0 MAX.
74054-028CAS/028CASLF	2.8	1.0	1.4 MAX.
74054-040CAS/040CASLF	4.0	0.3	1.0 MAX.
74054-043CAS/043CASLF	4.3	0.3	1.4 MAX.
74054-050CAS/050CASLF	5.0	0.3	

P/N: 74054-000CAS/000CASLF
ABOVE P.C.B

P/N: 74054-0**CAS/0**CASLF
ABOVE P.C.B

mat'l. code		surface	tolerance	projection	product family
		ISO 1302	ISO 406	ISO 1181	
ltr ecn no dr date		tolerances unless otherwise specified			title
v		angles	linear	± 0.30	CARBUS SINGLE DECK 2-STEP, TYPE 1/2/3
		±2'		MM	
		scale			dwg no
		dr WENDY CHEN 09/23/97			sheet 3 of 0
		enr STELAR CHU 09/23/97			size
		chr JOSEPH HSIA 09/23/97			74054
		app JENN TSAO 09/23/97			A4
		type CUSTOMER			Drawing
sheet index	revision sheet				

FCI CONFIDENTIAL



This document is the property of and embodies CONFIDENTIAL and PROPRIETARY information of FCI. No part of this information shown on this document may be used in any way or disclosed to others without the written consent of FCI.



Copyright FCI

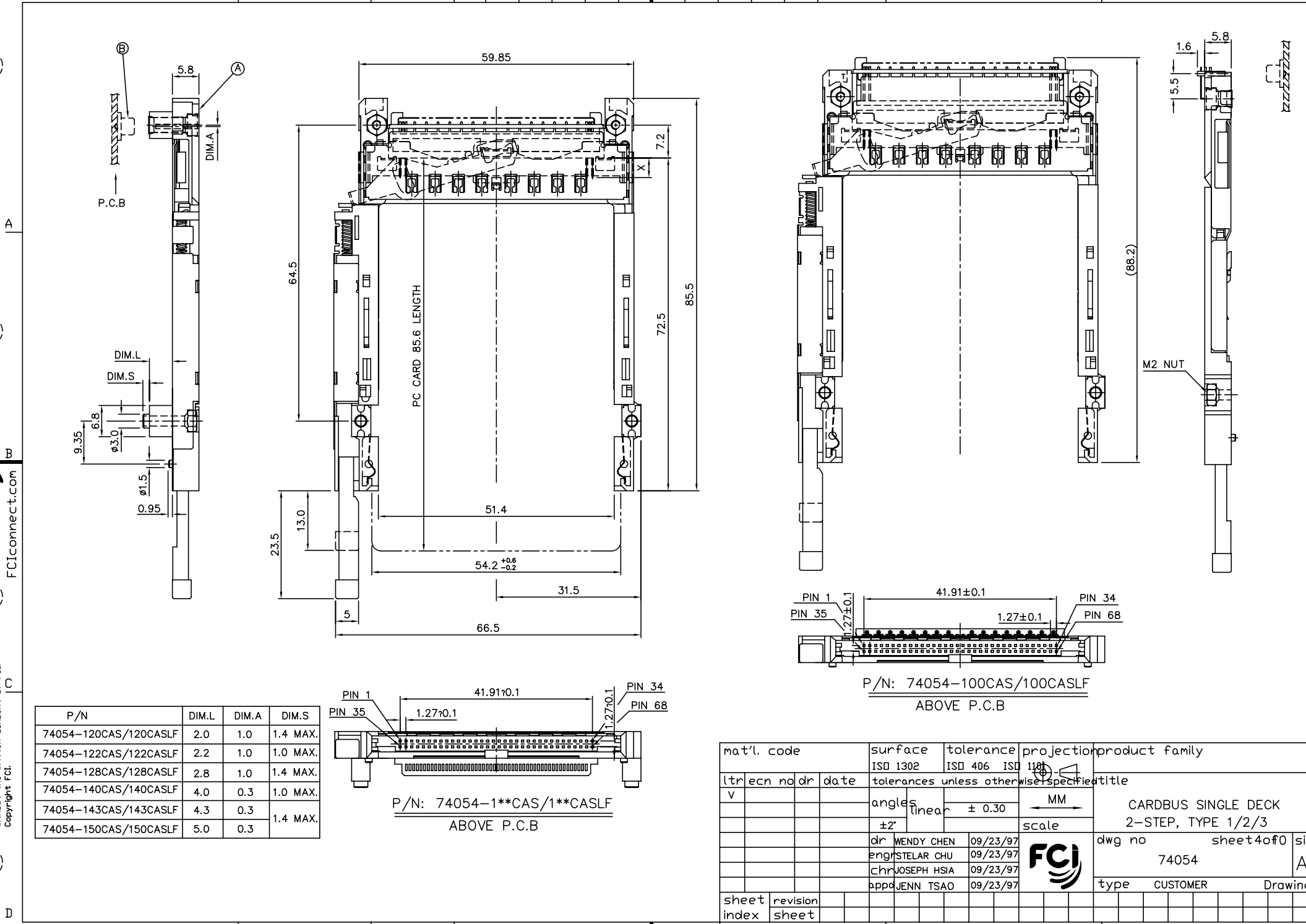

P/N	DIM.L	DIM.A	DIM.S
74054-120CAS/120CASLF	2.0	1.0	1.4 MAX.
74054-122CAS/122CASLF	2.2	1.0	1.0 MAX.
74054-128CAS/128CASLF	2.8	1.0	1.4 MAX.
74054-140CAS/140CASLF	4.0	0.3	1.0 MAX.
74054-143CAS/143CASLF	4.3	0.3	1.4 MAX.
74054-150CAS/150CASLF	5.0	0.3	1.4 MAX.

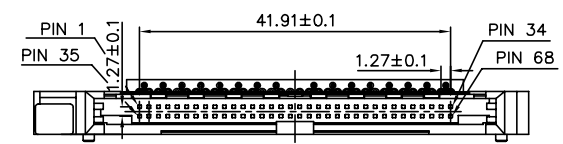
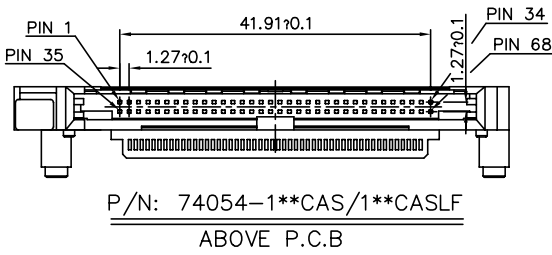

P/N: 74054-100CAS/100CASLF
ABOVE P.C.B

mat'l. code	surface ISO 1302	tolerance ISO 406 ISO 1101	projection 1:1	product family
tr/ecn no/dr	tolerances unless otherwise specified			title
v	angles ±2'	linear ± 0.30	MM	CARDBUS SINGLE DECK 2-STEP, TYPE 1/2/3
	dr WENDY CHEN	09/23/97	scale	dwg no
	engr STELAR CHU	09/23/97	FCI	74054
	chr JOSEPH HSIA	09/23/97		sheet 4 of 0
	app JENN TSAO	09/23/97	type	CUSTOMER Drawing
sheet index	revision sheet			size A4

FCI CONFIDENTIAL



This document is the property of and embodies CONFIDENTIAL and PROPRIETARY information of FCI. No part of this information shown on this document may be used in any way or disclosed to others without the written consent of FCI.
Copyright FCI.

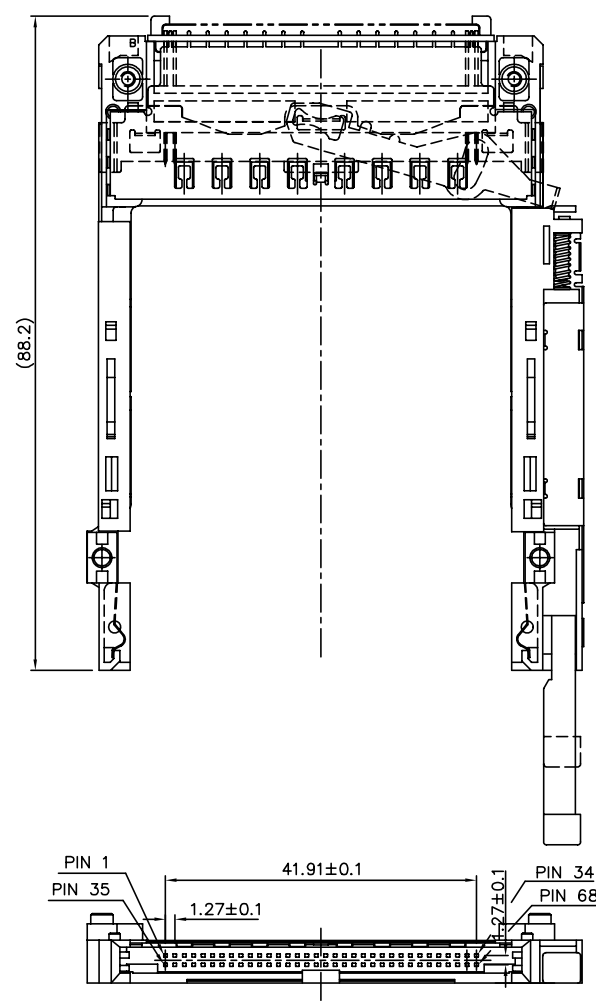
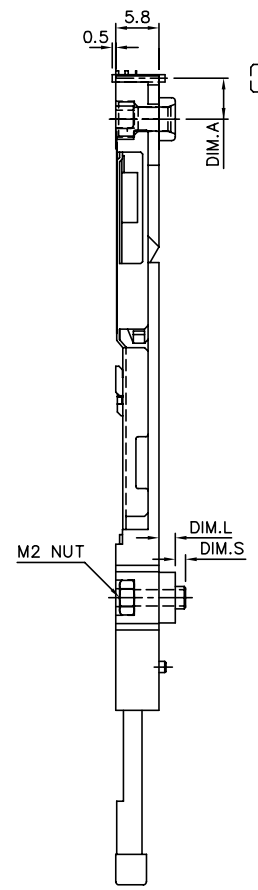
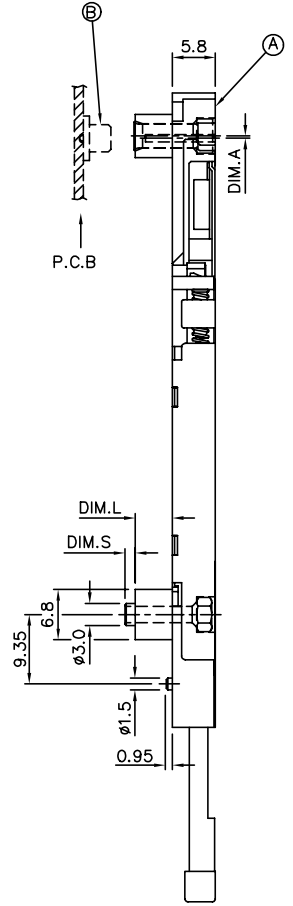
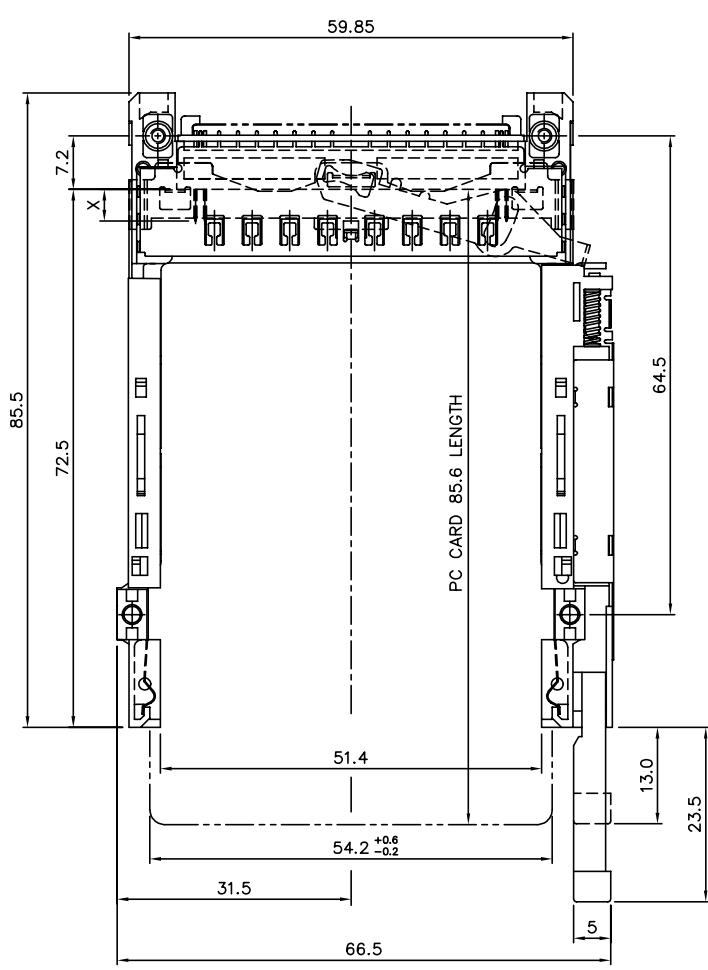

74054-522CAS/522CASLF
BELOW BOARD

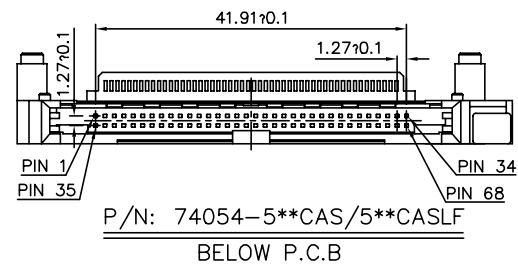

P/N	DIM.L	DIM.A	DIM.S
74054-522CAS/522CASLF	2.2	5.5	1.4 MAX.
74054-540CAS/540CASLF	4.0	0.3	1.0 MAX.
74054-543CAS/543CASLF	4.3	0.3	1.4 MAX.
74054-550CAS/550CASLF	5.0	0.3	

mat'l. code		surface	tolerance	projection	product family		
		ISO 1302	ISO 406 ISO 1181				
tr	ec	no	dr	date	tolerances unless otherwise specified		
v					title		
					angles		
					linear ± 0.30		
					±2'		
					scale		
		dr	WENDY CHEN	09/23/97			
		engr	STELAR CHU	09/23/97			
		chr	JOSEPH HSIA	09/23/97			
		app	JENN TSAO	09/23/97			
					dwg no	sheet 5 of 0	size
					74054		A4
					type	CUSTOMER	Drawing
sheet	revision						
index	sheet						

FCI CONFIDENTIAL



This document is the property of and embodies CONFIDENTIAL and PROPRIETARY information of FCI. No part of this information shown on this document may be used in any way or disclosed to others without the written consent of FCI.
Copyright FCI.

FCIconnect.com

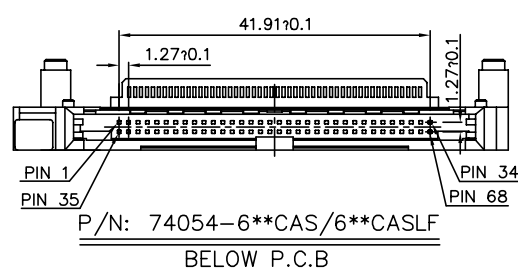
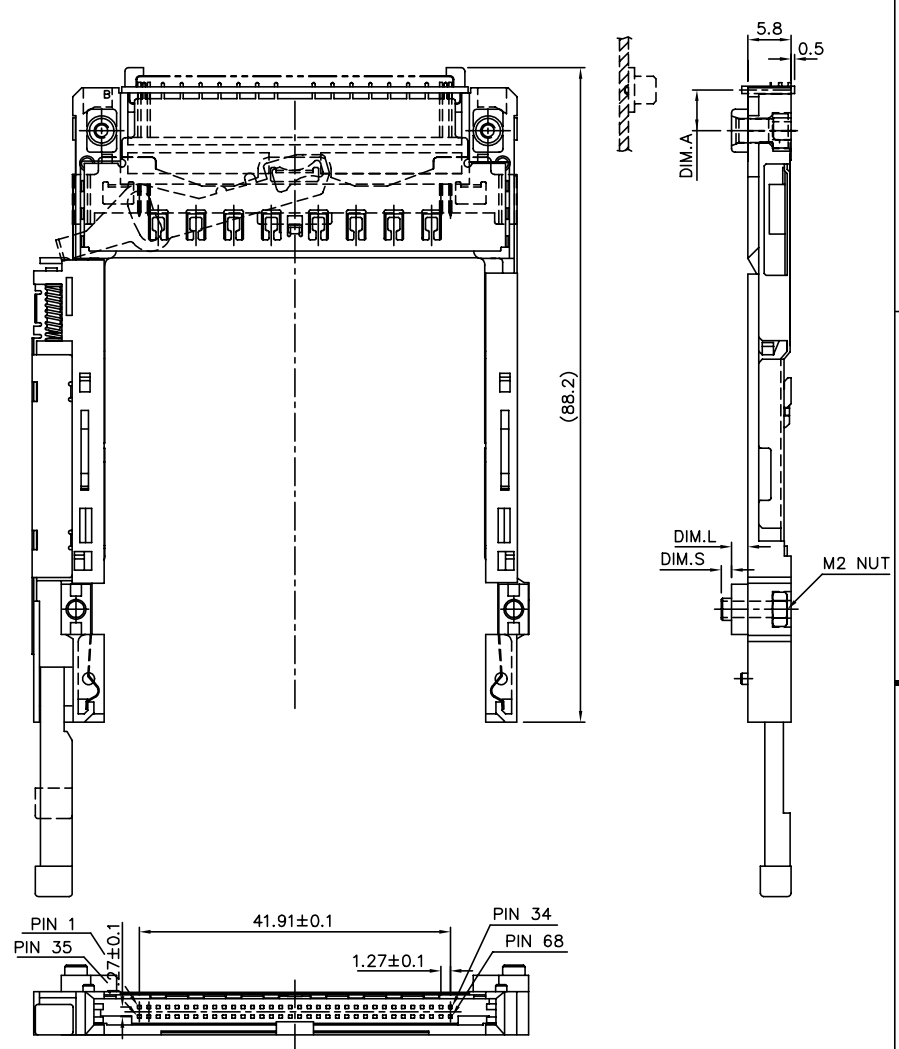
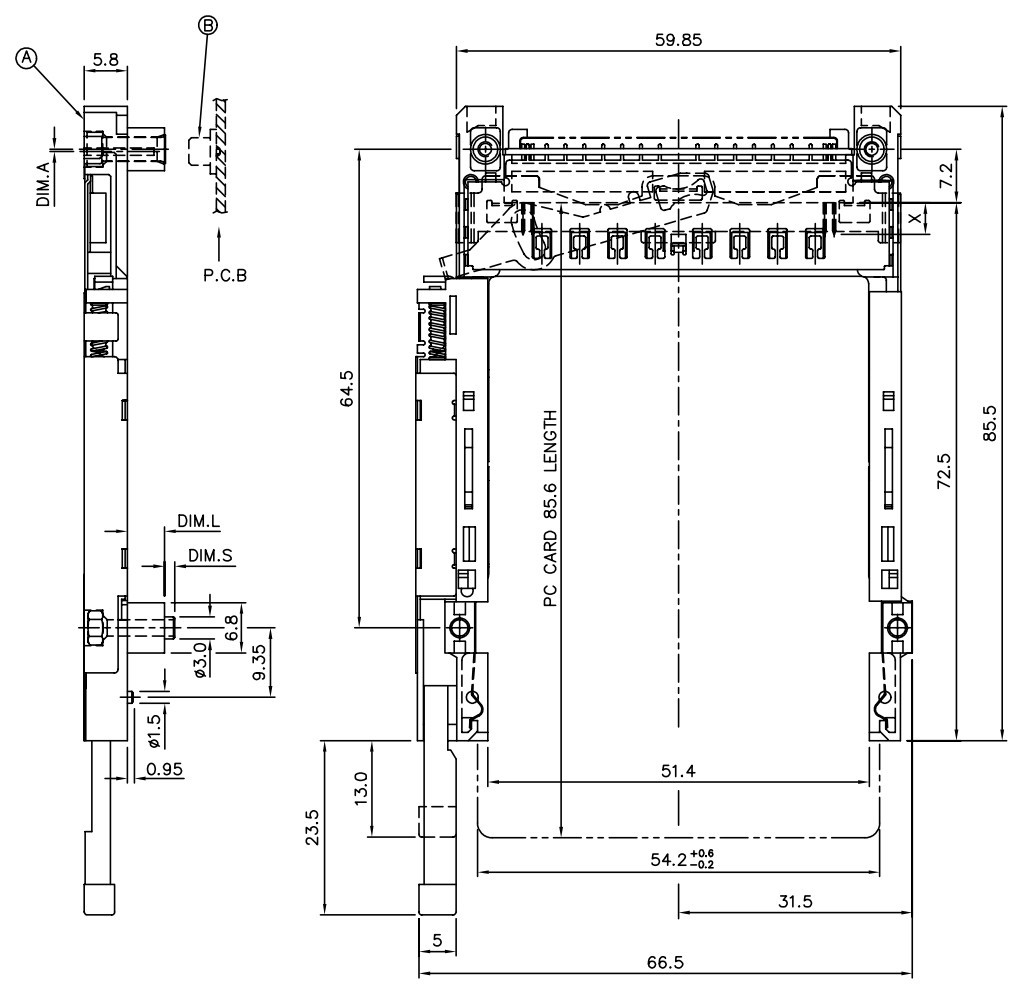

P/N	DIM.L	DIM.A	DIM.S
74054-622CAS/622CASLF	2.2	5.5	1.4 MAX.
74054-640CAS/640CASLF	4.0	0.3	1.0 MAX.
74054-643CAS/643CASLF	4.3	0.3	1.4 MAX.
74054-650CAS/650CASLF	5.0	0.3	

74054-622CAS/622CASLF
BELOW BOARD

mat'l. code	surface	tolerance	projection	product family
	ISO 1302	ISO 406	ISO 1181	CARDBUS SINGLE DECK
tr	ec	n	o	r
date	tolerances unless otherwise specified	linear	± 0.30	title
	angles	± 2'	MM	CARDBUS SINGLE DECK
			scale	2-STEP, TYPE 1/2/3
	dr	WENDY CHEN	09/23/97	dwg no
	engr	STELAR CHU	09/23/97	74054
	chr	JOSEPH HSIA	09/23/97	sheet 6 of 0
	app	JENN TSAO	09/23/97	size
				A4
sheet	revision			type
index	sheet			CUSTOMER
				Drawing

FCI CONFIDENTIAL



This document is the property of and embodies CONFIDENTIAL and PROPRIETARY information of FCI. No part of the information shown on this document may be used in any way or disclosed to others without the written consent of FCI. Copyright FCI.

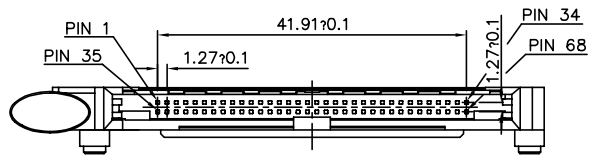
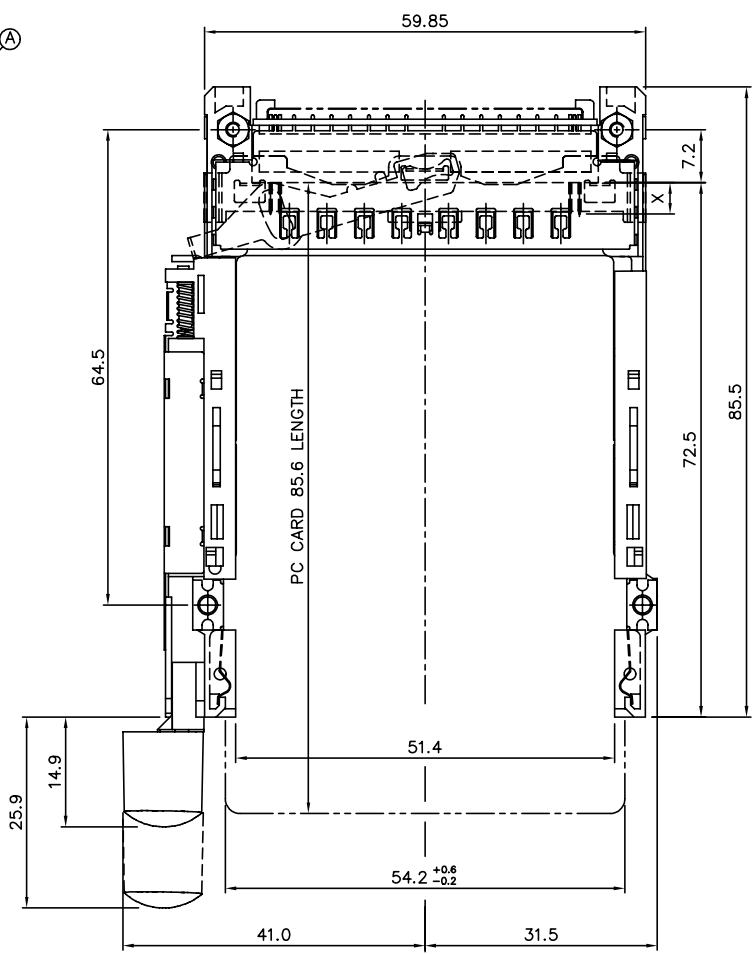
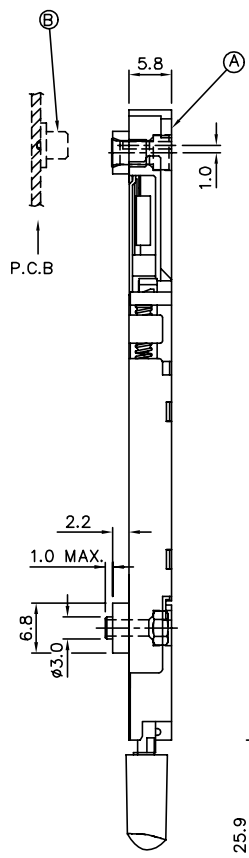

P/N: 74054-122CAT/122CATLF ABOVE P.C.B

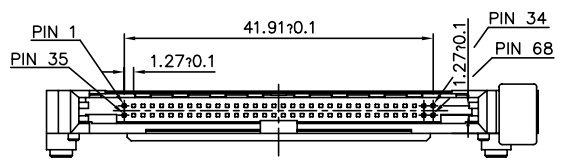
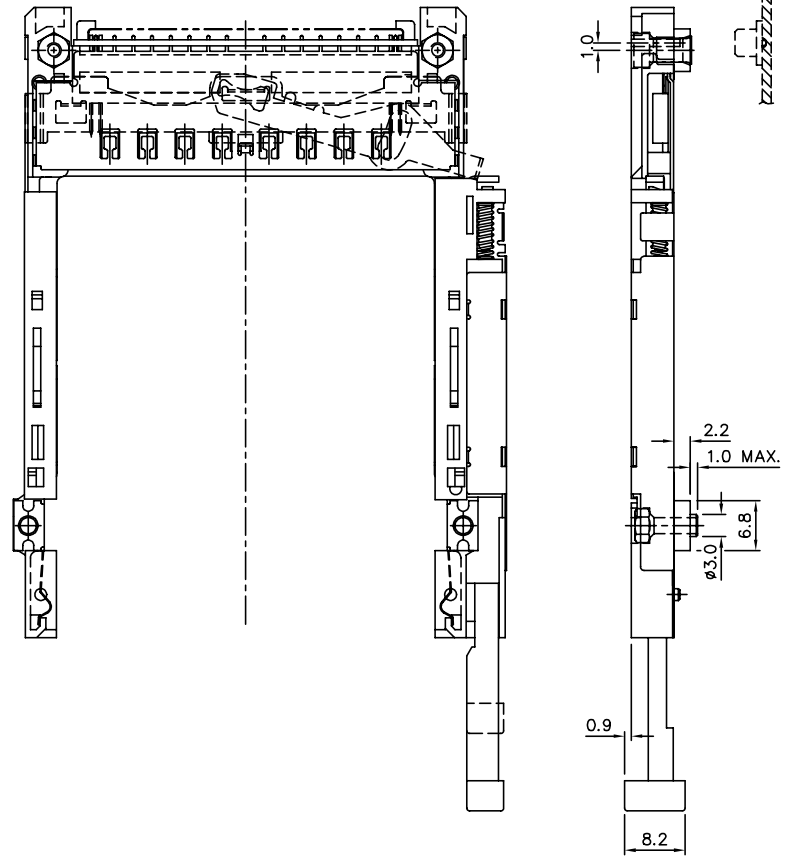

P/N: 74054-022CAR /022CARLF ABOVE P.C.B

mat'l. code	surface	tolerance	projection	product family
	ISD 1302	ISD 406 ISD 110		CARBUS SINGLE DECK
ltr ecn no dr date	tolerances unless otherwise specified			2-STEP, TYPE 1/2/3
v	angles	linear	± 0.30	MM
	±2'		scale	
	dr WENDY CHEN	09/23/97	FCI	dwg no 74054
	engr STELAR CHU	09/23/97		sheet 7 of 10
	chr JOSEPH HSIA	09/23/97		size A4
	appr JENN TSAO	09/23/97		type CUSTOMER Drawing
sheet index	revision sheet			

FCI CONFIDENTIAL

FCI
FCIconnect.com

This document is the property of and embodies CONFIDENTIAL and PROPRIETARY information of FCI. No part of this information shown on this document may be used in any way or disclosed to others without the written consent of FCI.
Copyright FCI.

PART NUMBER
74054-322CAS
74054-322CASLF

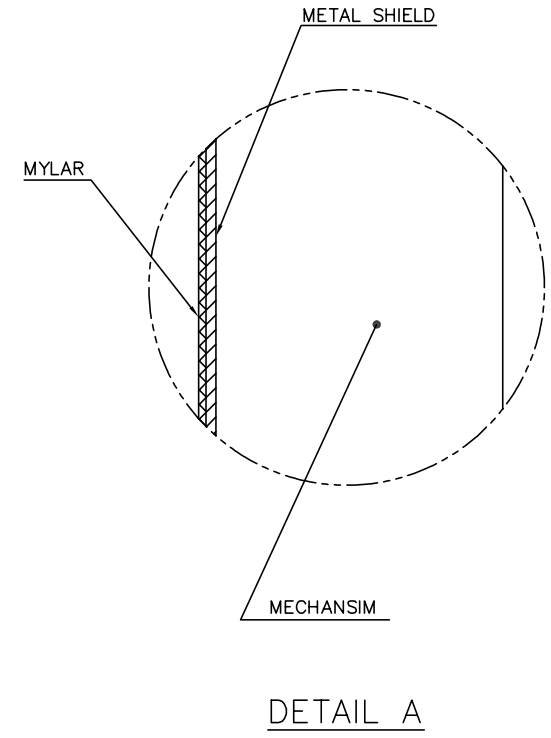
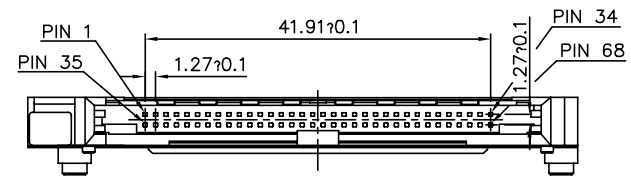
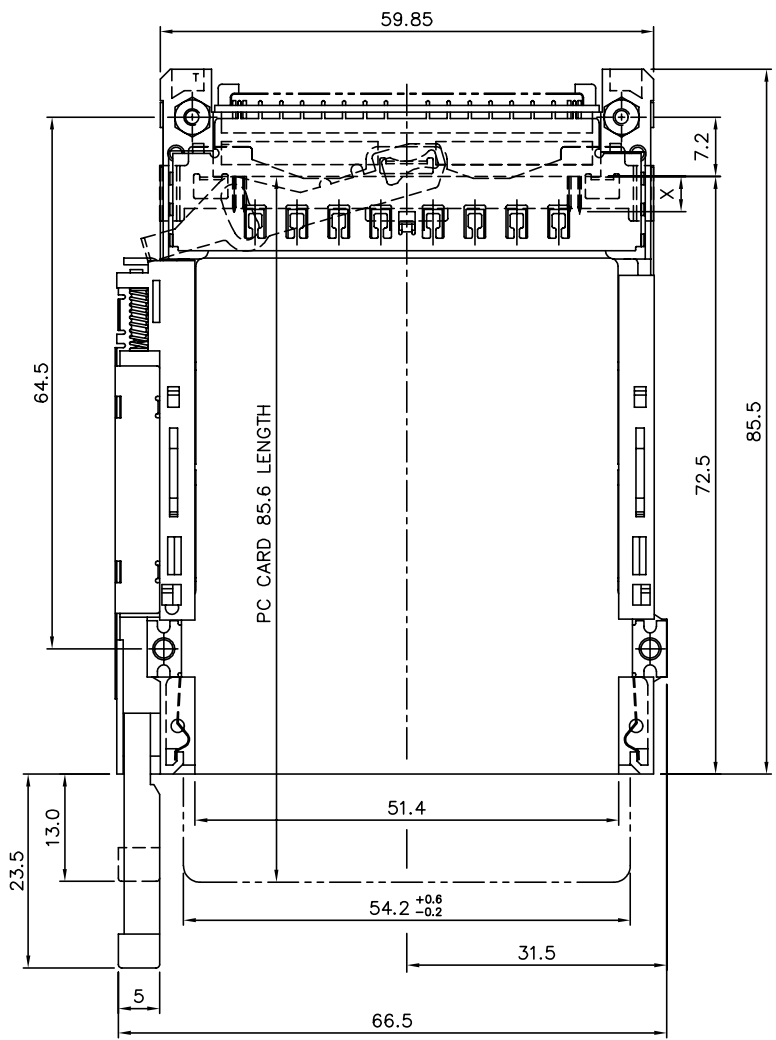
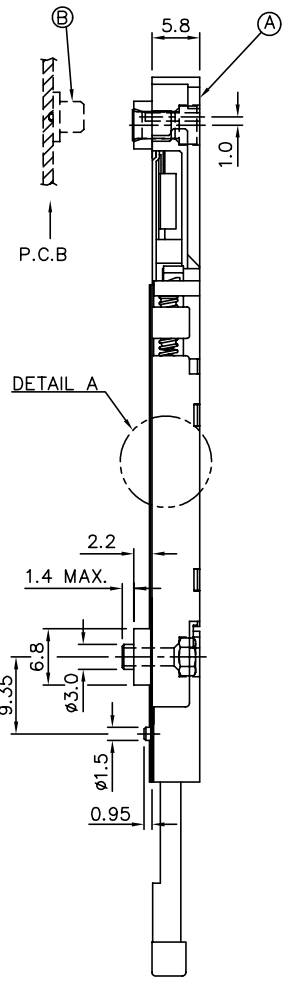

mat'l. code	surface ISO 1302	tolerance ISO 406 ISO 1181	projection 1:1	product family
trn ecn no dr date	tolerances unless otherwise specified			title
v	angles ±2'	linear ± 0.30	MM	CARDBUS SINGLE DECK 2-STEP, TYPE 1/2/3
	dr WENDY CHEN 09/23/97	engr STELAR CHU 09/23/97	chr JOSEPH HSIA 09/23/97	app JENN TSAO 09/23/97
sheet index	revision sheet	FCI		dwg no 74054 sheet 8 of 10 size A4
				type CUSTOMER Drawing

FCI CONFIDENTIAL

FCI
FCIconnect.com
This document is the property of and embodies CONFIDENTIAL and PROPRIETARY information of FCI. No part of this information shown on this document may be used in any way or disclosed to others without the written consent of FCI.
Copyright FCI.

PART NUMBER	PUSH ROD COLOR
74054-740CAS-B	BLACK

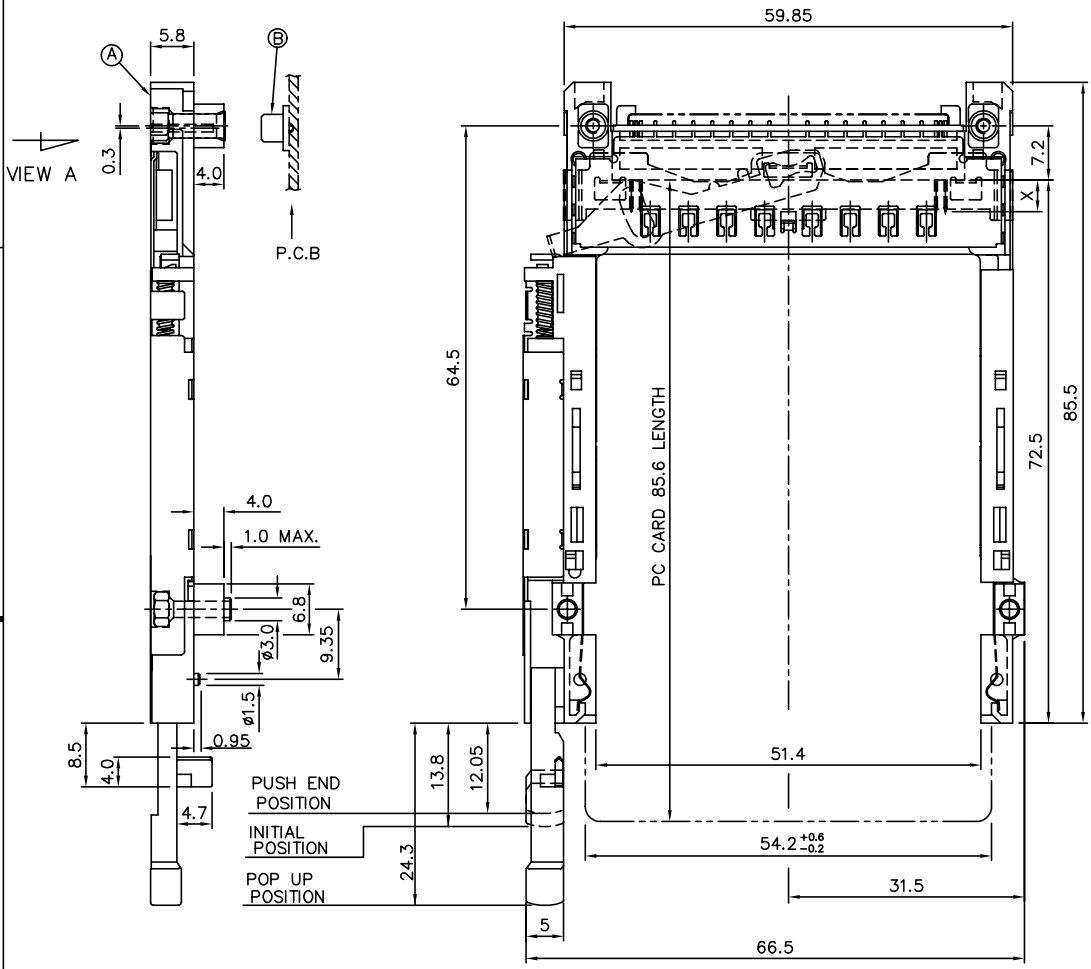

VIEW A
(FOR 74054-740CAS-B/840CAS ONLY)

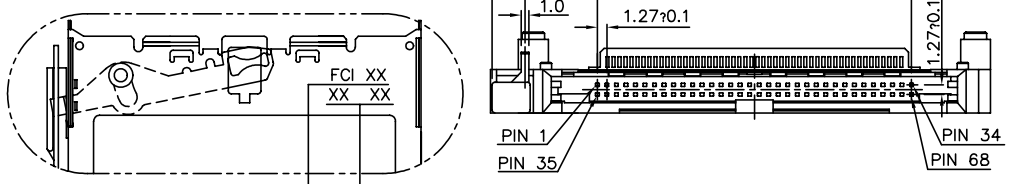

XX XX : MONTH / DAY
(MANUFACTURE DATE)
XX: YEAR

PART NUMBER	PUSH ROD COLOR
74054-840CAS	BLACK

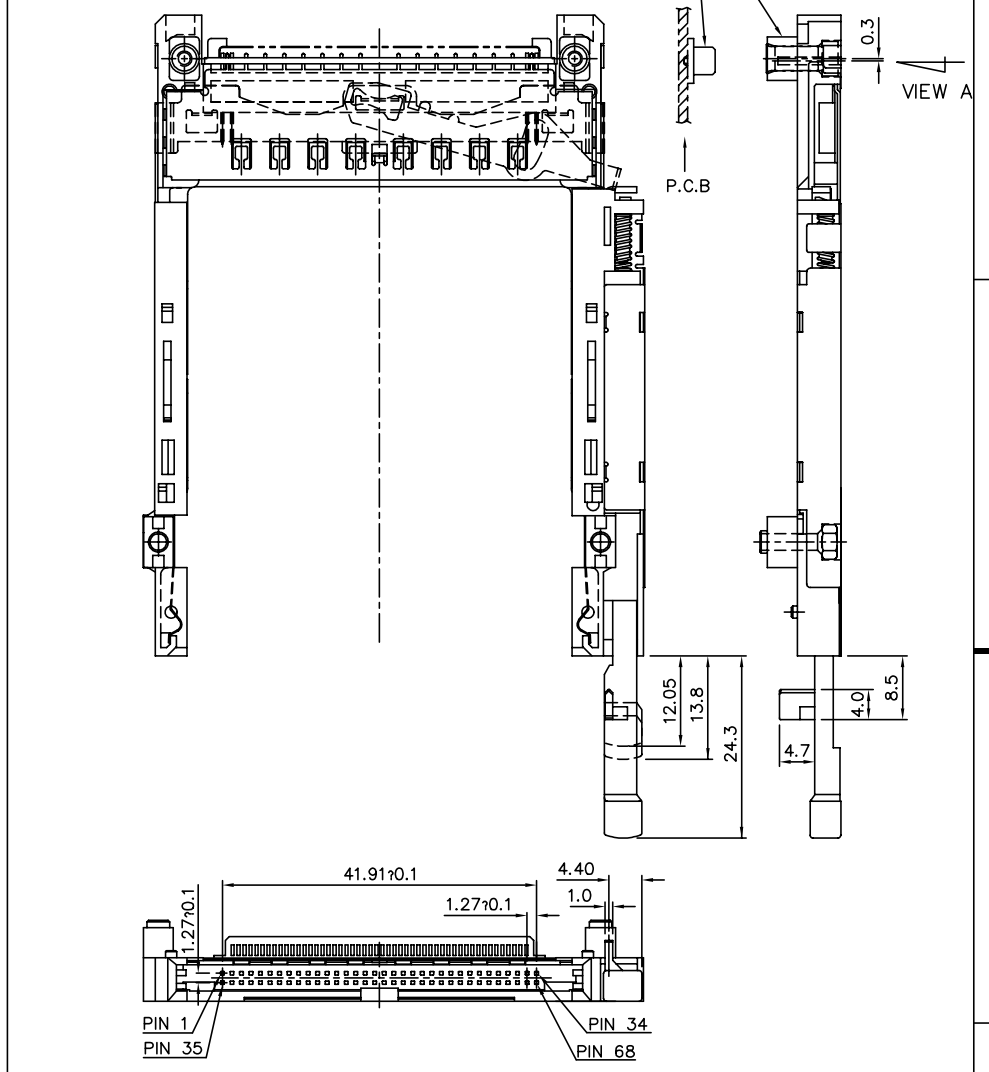

mat'l. code	surface ISO 1302	tolerance ISO 406 ISO 1181	projection 1:1	product family
trn ecn no dr date	tolerances unless otherwise specified			
v	angles ±2'	linear ± 0.30	MM	CARDBUS SINGLE DECK 2-STEP, TYPE 1/2/3
	dr WENDY CHEN 09/23/97	engr STELAR CHU 09/23/97	scale	dwg no 74054 sheet 9 of 10 size A4
	chr JOSEPH HSIA 09/23/97	app JENN TSAO 09/23/97	FCI	type CUSTOMER Drawing

sheet index	revision sheet																		
-------------	----------------	--	--	--	--	--	--	--	--	--	--	--	--	--	--	--	--	--	--

