



Chipsmall Limited consists of a professional team with an average of over 10 year of expertise in the distribution of electronic components. Based in Hongkong, we have already established firm and mutual-benefit business relationships with customers from,Europe,America and south Asia,supplying obsolete and hard-to-find components to meet their specific needs.

With the principle of “Quality Parts,Customers Priority,Honest Operation,and Considerate Service”,our business mainly focus on the distribution of electronic components. Line cards we deal with include Microchip,ALPS,ROHM,Xilinx,Pulse,ON,Everlight and Freescale. Main products comprise IC,Modules,Potentiometer,IC Socket,Relay,Connector.Our parts cover such applications as commercial,industrial, and automotives areas.

We are looking forward to setting up business relationship with you and hope to provide you with the best service and solution. Let us make a better world for our industry!



Contact us

Tel: +86-755-8981 8866 Fax: +86-755-8427 6832

Email & Skype: info@chipsmall.com Web: www.chipsmall.com

Address: A1208, Overseas Decoration Building, #122 Zhenhua RD., Futian, Shenzhen, China



TABLE OF CONTENTS	
SHEET NO.	SHEET DESCRIPTION
1	NOTES AND BOM
2	CONFIGURATIONS
3	KEY CONFIGURATIONS
4	RECEPTACLE CONNECTOR ASSEMBLY

NOTES: VALID UNLESS OTHERWISE SPECIFIED

1. GENERAL:
- a. APPLICATION SPECIFICATION SEE: AS-33472-100
 - CONTAINS: PRODUCT INTRODUCTION, PRODUCT SUMMARY, CONNECTOR ASSEMBLY, PACKAGING INFORMATION, CONNECTOR MATING, SERVICE INSTRUCTIONS, ELECTRICAL CONTINUITY CHECKING, CRIMPING, AND TROUBLESHOOTING.
 - DESIGNED TO MATE WITH DEVICE OR CONNECTOR AS SPECIFIED IN THE MATING INTERFACE/CONNECTOR DRAWINGS CHART.
 - DENOTES DRAWINGS THAT CAN BE ACCESSED AT <http://ewcap.uscarteams.org/>.
 - ASSEMBLY SHIPPED WITH PLR IN PRE-LOCK POSITION (SEE PLR PRE-LOCK VIEW SHEET 4).
 - b. PRODUCT SPECIFICATION SEE: PS-33476-000
 - CONTAINS: PRODUCT INTRODUCTION, PRODUCT SUMMARY, RATINGS (CURRENT, TEMPERATURE, SEALING, AND FLAMMABILITY), TERMINALS, WIRE DIAMETER RANGE, PRODUCT VALIDATION, AND PRODUCT DEVIATIONS.
 - c. PACKAGING SPECIFICATION PER MOLEX DRAWING: SEE PACKAGING CHART
 - d. PARTS MUST BE IN COMPLIANCE TO MOLEX CHEMICAL SUBSTANCES FOR PRODUCTS AND PACKAGING SPECIFICATION: QEHS-699000-300
 - e. DATA MUST BE SUBMITTED UNDER THE MOLEX PART NUMBER TO IMDS (COMPANY ID#13255)
2. DESIGN - MATERIALS:
- a. SEE BOM TABLE IN SD-34985-8002
3. DESIGN - GEOMETRY:
- a. THE 3-D CAD DATA IS BASIC (WITHOUT TOLERANCE) AND MASTER FOR THIS PART WITH THE EXCEPTION OF UNDERLINED DIMENSIONS. DIMENSIONAL INFORMATION NOT SHOWN ON THIS DRAWING IS DEFINED BY THE DATA FILE AT ITS LATEST REVISION.
 - b. GEOMETRIC DIMENSIONS AND TOLERANCES PER ASME Y14.5M-2009
 - c. EDGES AND UNDIMENSIONED DETAILS PER ISO13715
 - d. CORNERS SHOWN AS SHARP TO BE R 0.2 MAX.
 - e. LETTERING SHALL BE 0.15 MAX RAISED IN 0.25 MAX RECESS PAD. THIS INCLUDES RECYCLING CODE, CAVITY ID, VENDOR IDENTIFICATION, AND CUSTOMER MATERIAL NUMBER.
 - f. VISUAL DEFECTS SHALL MEET COSMETIC STANDARD PS-45499-002 (Class B).
 - g. LASER MARKING:
 - 1. PART NUMBER
 - 2. DAY OF THE YEAR
 - 3. SHIFT
 - 4. YEAR
- FOR ADDITIONAL INFORMATION SEE SECTION 5 UNDER PROCEDURES IN ES-34735-008.

PACKAGING	
DESCRIPTION	DRAWING NO.
W/ CLIPSLOT	PK-30907-895
W/O CLIPSLOT	PK-31300-094

MATING INTERFACE/CONNECTOR DRAWINGS		
DESCRIPTION	INTERFACE DEFINITION	MOLEX INLINE
W/O SHORTING BAR	*999-S-016-2-Z02	SD-34986-8001
W/ SHORTING BAR	N/A	SD-34986-8001

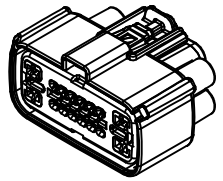
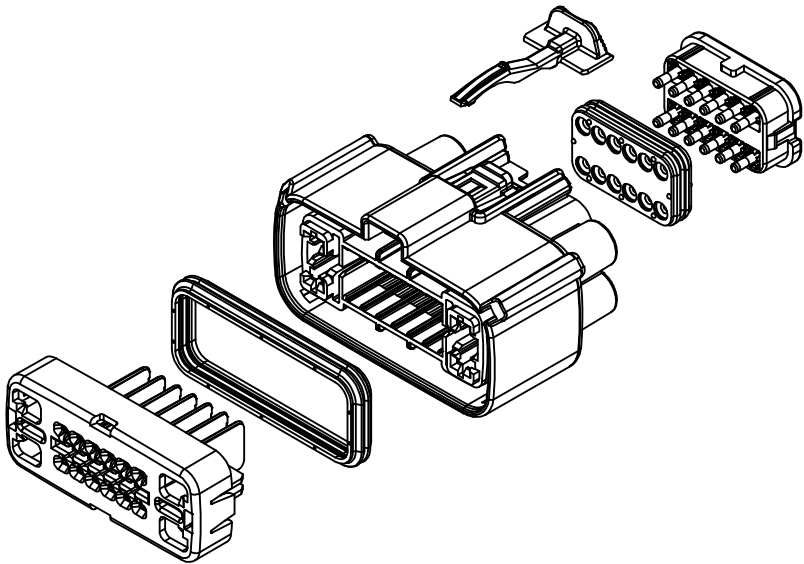

D	REMOVED BOM (REFER TO SD-34985-8002)
C	NEW P/N 34985-4026 THRU 4028
B	NEW P/N 34985-4023 THRU 4025
A2	UPDATED PACKAGING DWGS
A1	FIXED TYPO IN NOTE 1a
A	INITIAL RELEASE

INSPECTION NUMBER LOG	REV	REV DESCRIPTION
LAST NUMBER: 11		
ADDED:	A	INITIAL RELEASE
REMOVED:		

ENTER DESCRIPTION ELEC NO: UA02015-0529 DRAWN BY: PROFFITT 2014/10/02 CHKD: APPR:WOSHY 2014/10/09	QUALITY SYMBOLS	GENERAL TOLERANCES (UNLESS SPECIFIED)	DIMENSION STYLE	DRAWN BY	DATE	TITLE
	▽=0	4 PLACES ± --- ± ---	MM ONLY	KCUNNINGHAM	2011/10/27	MX150 16 WAY HYBRID RECEPTACLE ASSEMBLY molex DOCUMENT NO. SD-34985-8001 SHEET NO. 1 OF 4
	▽=0	3 PLACES ± --- ± ---		CHECKED BY	DATE	
	▽=0	2 PLACES ± 0.1 ± ---		APPROVED BY	DATE	
▽=0	1 PLACE ± 0.3 ± ---					
		0 PLACE ± ±				
		ANGULAR ± 3 °		MATERIAL NO.		
		DRAFT WHERE APPLICABLE MUST REMAIN WITHIN DIMENSIONS		SEE NOTE 2a.		
				SIZE 1		THIS DRAWING CONTAINS INFORMATION THAT IS PROPRIETARY TO MOLEX INCORPORATED AND SHOULD NOT BE USED WITHOUT WRITTEN PERMISSION

SHEET DESCRIPTION

CONFIGURATIONS

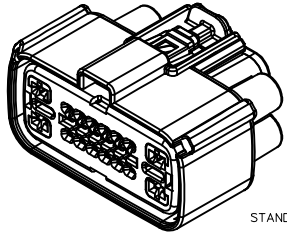

STANDARD (STD) - ALL OPEN 2.8mm CAVITIES

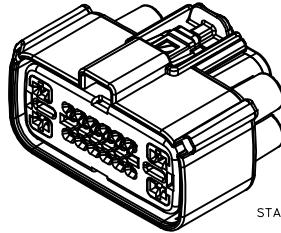
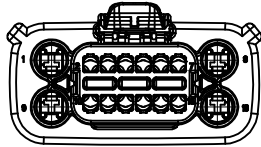

STANDARD (STD) - ALL OPEN 2.8mm CAVITIES WITH CLIPSLOT

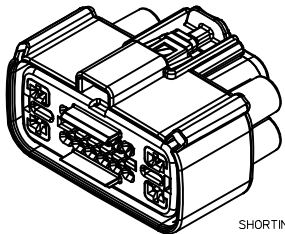
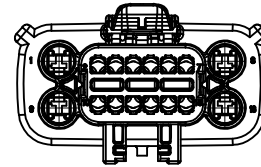

SHORTING (SHRT) BAR - ALL OPEN 2.8mm CAVITIES

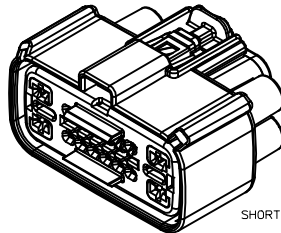
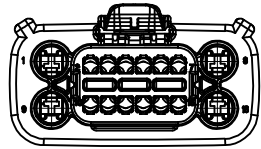

SHORTING (SHRT) BAR - ALL OPEN 2.8mm CAVITIES WITH CLIPSLOT

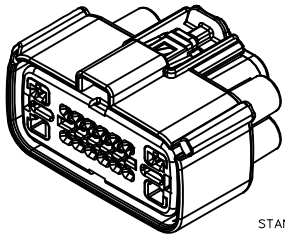
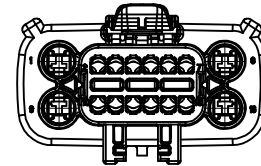

STANDARD (STD) - BLOCKED 2.8mm CAVITIES

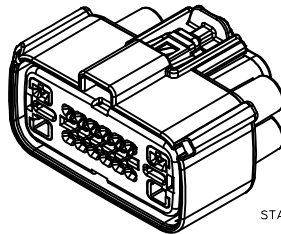
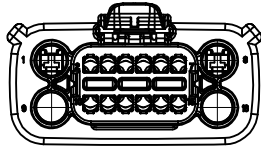

STANDARD (STD) - BLOCKED 2.8mm CAVITIES WITH CLIPSLOT

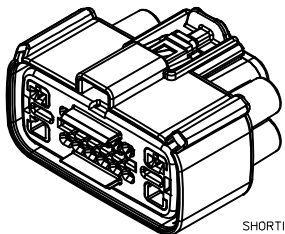
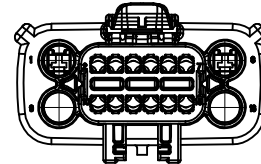

SHORTING (SHRT) BAR - BLOCKED 2.8mm CAVITIES

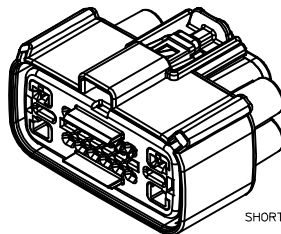
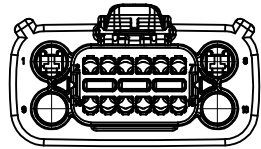

SHORTING (SHRT) BAR - BLOCKED 2.8mm CAVITIES WITH CLIPSLOT

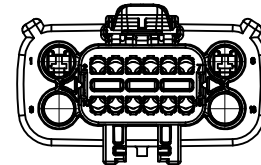

ENTER DESCRIPTION EEC NO: UAU2015-0529 DRAWN/PROFIT: 2014/10/02 CHKD: APPR:WOSHY 2014/10/09	QUALITY SYMBOLS ▽=0 ▽=0 ▽=0	GENERAL TOLERANCES (UNLESS SPECIFIED) mm INCH 4 PLACES ± --- ± --- 3 PLACES ± --- ± --- 2 PLACES ± 0.1 ± --- 1 PLACE ± 0.3 ± --- 0 PLACE ± ±	DIMENSION STYLE MM ONLY	SCALE 2:1	DESIGN UNITS METRIC	THIRD ANGLE PROJECTION	
	DRAWN BY KCUNNINGHAM	DATE 2011/10/27	CHECKED BY DATE	APPROVED BY DATE	TITLE MX150 16 WAY HYBRID RECPD SEALED ASSEMBLY		
	MATERIAL NO. SEE NOTE 2a.			DOCUMENT NO. SD-34985-8001			SHEET NO. 2 OF 4
	DRAFT WHERE APPLICABLE MUST REMAIN WITHIN DIMENSIONS						THIS DRAWING CONTAINS INFORMATION THAT IS PROPRIETARY TO MOLEX INCORPORATED AND SHOULD NOT BE USED WITHOUT WRITTEN PERMISSION

SHEET DESCRIPTION

KEY CONFIGURATIONS

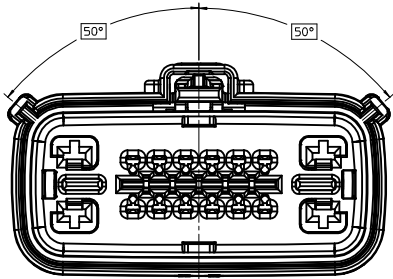

KEY A

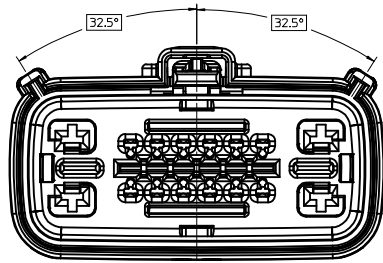

KEY E

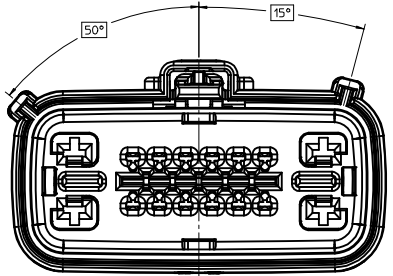

KEY B

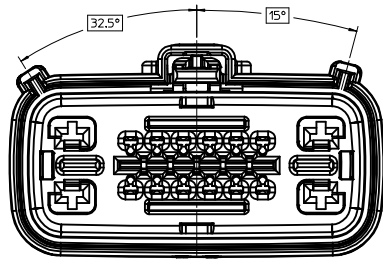

KEY F

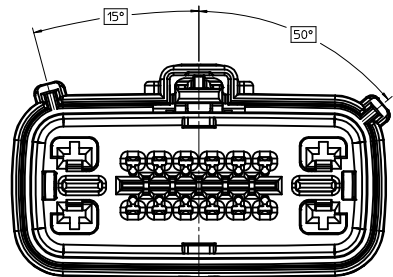

KEY C

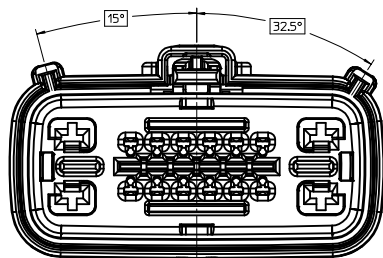

KEY G

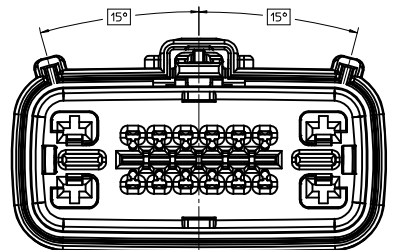

KEY D

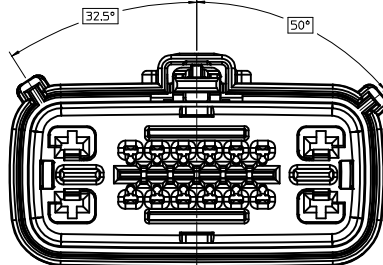

KEY H

ENTER DESCRIPTION EC NO: UAI2015-0529 DRAWN/APPROV ITT 2014/10/02 CHKD: APPR:WKSHY 2014/10/09	QUALITY SYMBOLS ▽=0 ▽=0 ▽=0	GENERAL TOLERANCES (UNLESS SPECIFIED) mm INCH 4 PLACES ± --- ± --- 3 PLACES ± --- ± --- 2 PLACES ± 0.1 ± --- 1 PLACE ± 0.3 ± --- 0 PLACE ± ±	DIMENSION STYLE MM ONLY	SCALE 3:1	DESIGN UNITS METRIC	THIRD ANGLE PROJECTION	
	DRAWN BY KCUNNINGHAM	DATE 2011/10/27	CHECKED BY DATE	TITLE MX150 16 WAY HYBRID RECEPT SEALED ASSEMBLY	MATERIAL NO. SEE NOTE 2a.	DOCUMENT NO. SD-34985-8001	SHEET NO. 3 OF 4
	DRAFT WHERE APPLICABLE MUST REMAIN WITHIN DIMENSIONS	ANGULAR ± 3 °	SEE NOTE 2a.	THIS DRAWING CONTAINS INFORMATION THAT IS PROPRIETARY TO MOLEX INCORPORATED AND SHOULD NOT BE USED WITHOUT WRITTEN PERMISSION			
	REV	DESCRIPTION	DATE	APPROVED BY DATE	DATE	DATE	DATE

SHEET DESCRIPTION

RECEPTACLE CONNECTOR ASSEMBLY

OPTIONAL LASER MARKING ON THIS SURFACE
SEE NOTE 3g.

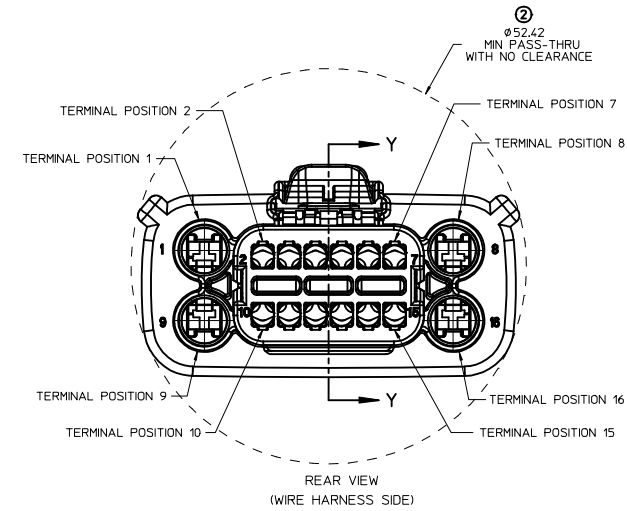
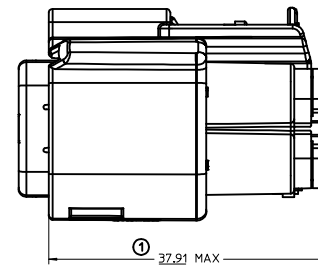
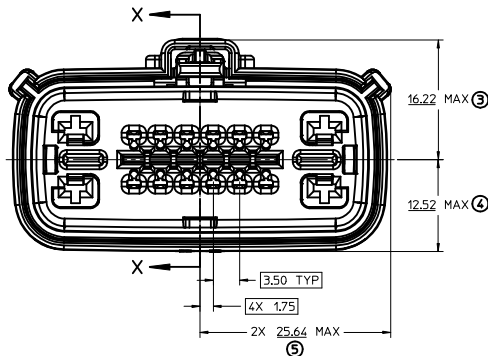
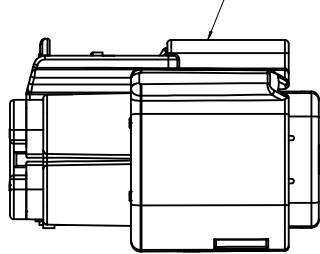

MANUFACTURING LOCATION
CODE THIS LOCATION

RECYCLE CODE
THIS LOCATION

MOLD CAVITY I.D.
THIS LOCATION

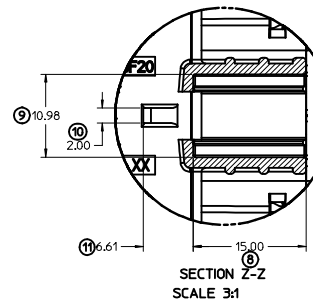
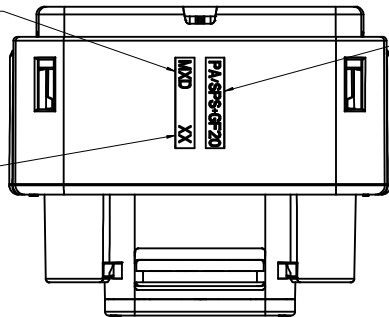

SECTION Z-Z
SCALE 3:1

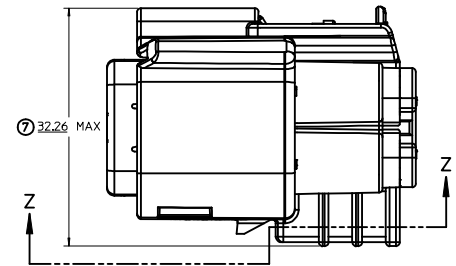

4.00+0.50
(6)

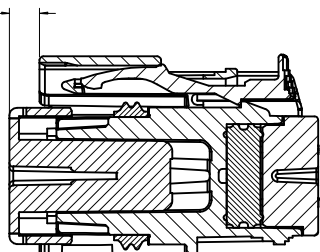

PRIMARY LOCK REINFORCEMENT (PLR) SHOWN
IN PRE-STAGED POSITION

SECTION X-X

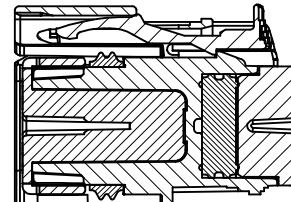

PRIMARY LOCK REINFORCEMENT (PLR) SHOWN
IN FINAL-LOCK POSITION

SECTION Y-Y

ENTER DESCRIPTION ELEC NO: UAU2015-0529 DRAWN: BROFFITT 2014/10/02 CHYK: APPR: WASHY 2014/10/05	QUALITY SYMBOLS	GENERAL TOLERANCES (UNLESS SPECIFIED)	DIMENSION STYLE MM ONLY	SCALE 3:1	DESIGN UNITS METRIC	THIRD ANGLE PROJECTION
	▽=0	4 PLACES ± --- ± ---	m/m	DRAWN BY KCUNNINGHAM	DATE 2011/10/27	TITLE MX150 16 WAY HYBRID RECP T SEALED ASSEMBLY
	▽=0.1	3 PLACES ± --- ± ---	INCH	CHECKED BY	DATE	molex MATERIAL NO. SEE NOTE 2a. DOCUMENT NO. SD-34985-8001
	▽=0.3	2 PLACES ± 0.1 ± ---		APPROVED BY	DATE	
▽=0	1 PLACE ± 0.3 ± ---	ANGULAR ± 3°	DRAFT WHERE APPLICABLE MUST REMAIN WITHIN DIMENSIONS			
▽=0	0 PLACE ± ±		THIS DRAWING CONTAINS INFORMATION THAT IS PROPRIETARY TO MOLEX INCORPORATED AND SHOULD NOT BE USED WITHOUT WRITTEN PERMISSION			

**MX150 16 WAY HYBRID RECEPTACLE SEALED ASSEMBLY MAT SEAL (WITHOUT CLIPSLOT, 2.8mm CAVITIES OPEN)
BOM AND PIN OUT SHEET**

ASSEMBLY DESCRIPTION	ASSEMBLY PART NUMBER	COMPONENT							BLOCKED TERMINALS																STATUS	COMMENTS	OPTIONAL ATTACHMENTS SOLD SEPERATELY																										
		THE PRESENCE OF AN ABBREVIATION INDICATES THE PRESENCE OF THAT COMPONENT.							CAVITY WITH A NUMBER INDICATES BLOCKED TERMINAL POSITION CAVITY WITHOUT A NUMBER INDICATES OPEN TERMINAL POSITION																		BACKSHELL WITH RIBS	BACKSHELL WITHOUT RIBS																									
		HOUSING KEY/COLOR	GROMMET CAP	PLR	CPA	MAT SEAL	RING SEAL	1	2	3	4	5	6	7	8	9	10	11	12	13	14	15	16																														
KEY A, BLACK, W/O CPA	34985-2159	A-BLK	GC	PLR		M	R			2																11										SALEABLE			NOT AVAILABLE	NOT AVAILABLE													
KEY C, DARK GRAY, W/CPA	34985-2160	C-DG	GC	PLR	CPA	M	R																															SALEABLE			NOT AVAILABLE	NOT AVAILABLE											
KEY A, YELLOW, W/CPA	34985-2161	A-YW	GC	PLR	CPA	M	R																																	SALEABLE			NOT AVAILABLE	NOT AVAILABLE									
KEY A, BLACK, W/CPA	34985-2162	A-BLK	GC	PLR	CPA	M	R																																		SALEABLE			NOT AVAILABLE	NOT AVAILABLE								
KEY B, LIGHT GRAY, W/CPA	34985-2163	B-LG	GC	PLR	CPA	M	R			2		3																														SALEABLE			NOT AVAILABLE	NOT AVAILABLE							
KEY B, LIGHT GRAY, W/O CPA	34985-2164	B-LG	GC	PLR		M	R			2		3																															SALEABLE			NOT AVAILABLE	NOT AVAILABLE						
KEY A, BLACK, W/CPA	34985-2165	A-BLK	GC	PLR	CPA	M	R																																				SALEABLE			NOT AVAILABLE	NOT AVAILABLE						
KEY A, BLACK, W/CPA	34985-2166	A-BLK	GC	PLR	CPA	M	R																																				SALEABLE			NOT AVAILABLE	NOT AVAILABLE						
KEY A, BLACK, W/CPA	34985-2167	A-BLK	GC	PLR	CPA	M	R				2		3																															SALEABLE			NOT AVAILABLE	NOT AVAILABLE					
KEY A, BLACK, W/CPA	34985-2168	A-BLK	GC	PLR	CPA	M	R																																				SALEABLE			NOT AVAILABLE	NOT AVAILABLE						
KEY B, LIGHT GRAY, W/CPA	34985-2169	B-LG	GC	PLR	CPA	M	R			2		3																																SALEABLE			NOT AVAILABLE	NOT AVAILABLE					
KEY C, DARK GRAY, W/CPA	34985-2170	C-DG	GC	PLR	CPA	M	R																																					SALEABLE			NOT AVAILABLE	NOT AVAILABLE					
KEY C, DARK GRAY, W/O CPA	34985-2171	C-DG	GC	PLR		M	R																																					SALEABLE			NOT AVAILABLE	NOT AVAILABLE					
KEY B, LIGHT GRAY, W/O CPA	34985-2172	B-LG	GC	PLR		M	R																																					SALEABLE			NOT AVAILABLE	NOT AVAILABLE					
KEY A, BLACK, W/CPA	34985-2173	A-BLK	GC	PLR	CPA	M	R																																						SALEABLE			NOT AVAILABLE	NOT AVAILABLE				
KEY A, BLACK, W/CPA	34985-2174	A-BLK	GC	PLR	CPA	M	R																																						SALEABLE			NOT AVAILABLE	NOT AVAILABLE				
KEY B, LIGHT GRAY, W/CPA	34985-2175	B-LG	GC	PLR	CPA	M	R				2			4		5																														SALEABLE			NOT AVAILABLE	NOT AVAILABLE			
KEY A, BLACK, W/CPA	34985-2176	A-BLK	GC	PLR	CPA	M	R																																							SALEABLE			NOT AVAILABLE	NOT AVAILABLE			
KEY B, LIGHT GRAY, W/CPA	34985-2177	B-LG	GC	PLR	CPA	M	R																																						SALEABLE			NOT AVAILABLE	NOT AVAILABLE				
KEY A, BLACK, W/O CPA	34985-2178	A-BLK	GC	PLR		M	R																																							SALEABLE			NOT AVAILABLE	NOT AVAILABLE			
KEY B, LIGHT GRAY, W/CPA	34985-2179	B-LG	GC	PLR	CPA	M	R																																							SALEABLE			NOT AVAILABLE	NOT AVAILABLE			
KEY B, LIGHT GRAY, W/O CPA	34985-2180	B-LG	GC	PLR	CPA	M	R																																							SALEABLE			NOT AVAILABLE	NOT AVAILABLE			
KEY B, LIGHT GRAY, W/CPA	34985-2181	B-LG	GC	PLR	CPA	M	R																																							SALEABLE			NOT AVAILABLE	NOT AVAILABLE			
KEY B, LIGHT GRAY, W/O CPA	34985-2182	B-LG	GC	PLR	CPA	M	R																																							SALEABLE			NOT AVAILABLE	NOT AVAILABLE			
KEY A, BLACK, W/CPA	34985-2183	A-BLK	GC	PLR	CPA	M	R																																							SALEABLE			NOT AVAILABLE	NOT AVAILABLE			
KEY D, STONE GRAY, W/CPA	34985-2184	D-SG	GC	PLR	CPA	M	R																																								SALEABLE			NOT AVAILABLE	NOT AVAILABLE		
KEY A, BLACK, W/O CPA	34985-2185	A-BLK	GC	PLR		M	R																																								SALEABLE			NOT AVAILABLE	NOT AVAILABLE		
KEY A, BLACK, W/O CPA	34985-2186	A-BLK	GC	PLR		M	R																																									SALEABLE			NOT AVAILABLE	NOT AVAILABLE	
KEY A, BLACK, W/O CPA	34985-2187	A-BLK	GC	PLR		M	R																																									SALEABLE			NOT AVAILABLE	NOT AVAILABLE	
KEY A, BLACK, W/CPA	34985-2188	A-BLK	GC	PLR	CPA	M	R																																								SALEABLE			NOT AVAILABLE	NOT AVAILABLE		
KEY A, BLACK, W/CPA	34985-2189	A-BLK	GC	PLR	CPA	M	R																																								SALEABLE			NOT AVAILABLE	NOT AVAILABLE		
KEY A, BLACK, W/O CPA	34985-2190	A-BLK	GC	PLR		M	R																																								SALEABLE			NOT AVAILABLE	NOT AVAILABLE		
KEY A, YELLOW, W/CPA	34985-2191	A-YW	GC	PLR	CPA	M	R																																										SALEABLE			NOT AVAILABLE	NOT AVAILABLE
KEY A, YELLOW, W/O CPA	34985-2192	A-YW	GC	PLR	CPA	M	R																																										SALEABLE			NOT AVAILABLE	NOT AVAILABLE
KEY B, LIGHT GRAY, W/CPA	34985-2193	B-LG	GC	PLR	CPA	M	R																																									SALEABLE			NOT AVAILABLE	NOT AVAILABLE	
KEY B, LIGHT GRAY, W/O CPA	34985-2194	B-LG	GC	PLR	CPA	M	R																																									SALEABLE			NOT AVAILABLE	NOT AVAILABLE	
KEY B, LIGHT GRAY, W/CPA	34985-2195	B-LG	GC	PLR	CPA	M	R																																									SALEABLE			NOT AVAILABLE	NOT AVAILABLE	
KEY A, BLACK, W/O CPA	34985-2196	A-BLK	GC	PLR		M	R																																									SALEABLE			NOT AVAILABLE	NOT AVAILABLE	
KEY A, BLACK, W/O CPA	34985-2197	A-BLK	GC	PLR		M	R																																										SALEABLE			NOT AVAILABLE	NOT AVAILABLE
KEY A, BLACK, W/O CPA	34985-2198	A-BLK</																																																			

MX150 16 WAY HYBRID RECEPTACLE SEALED ASSEMBLY MAT SEAL (WITHOUT CLIPSLOT, 2.8mm CAVITIES OPEN)
BOM AND PIN OUT SHEET

ASSEMBLY DESCRIPTION	ASSEMBLY PART NUMBER	COMPONENT						BLOCKED TERMINALS																STATUS	COMMENTS	OPTIONAL ATTACHMENTS SOLD SEPERATELY	
		THE PRESENCE OF AN ABBREVIATION INDICATES THE PRESENCE OF THAT COMPONENT.						CAVITY WITH A NUMBER INDICATES BLOCKED TERMINAL POSITION CAVITY WITHOUT A NUMBER INDICATES OPEN TERMINAL POSITION																		BACKSHELL WITH RIBS	BACKSHELL WITHOUT RIBS
		HOUSING KEY/COLOR	GROMMET CAP	PLR	CPA	MAT SEAL	RING SEAL	1	2	3	4	5	6	7	8	9	10	11	12	13	14	15	16				
KEY A, BLACK, W/O CPA	34985-4055	A-BLK	GC	PLR		M	R									10	11	12		14	15		SALEABLE		NOT AVAILABLE	NOT AVAILABLE	
KEY B, LIGHT GRAY, W/CPA	34985-4056	B-LG	GC	PLR	CPA	M	R		2	3	4							12	13	14	15		SALEABLE		NOT AVAILABLE	NOT AVAILABLE	
KEY A, BLACK, W/O CPA	34985-4057	A-BLK	GC	PLR		M	R		2						10	11							SALEABLE		NOT AVAILABLE	NOT AVAILABLE	
KEY A, BLACK, W/O CPA	34985-4058	A-BLK	GC	PLR		M	R		2						10	11				14	15		SALEABLE		NOT AVAILABLE	NOT AVAILABLE	
KEY A, BLACK, W/O CPA	34985-4059	A-BLK	GC	PLR		M	R		2	3					10	11	12	13			15		SALEABLE		NOT AVAILABLE	NOT AVAILABLE	
KEY A, BLACK, W/O CPA	34985-4060	A-BLK	GC	PLR		M	R			3					10	11	12	13			15		SALEABLE		NOT AVAILABLE	NOT AVAILABLE	
KEY A, BLACK, W/O CPA	34985-4061	A-BLK	GC	PLR		M	R		2	3					10						15		SALEABLE		NOT AVAILABLE	NOT AVAILABLE	
KEY A, BLACK, W/O CPA	34985-4062	A-BLK	GC	PLR		M	R			3					10						15		SALEABLE		NOT AVAILABLE	NOT AVAILABLE	
KEY B, LIGHT GRAY, W/O CPA	34985-4063	B-LG	GC	PLR		M	R		2									13	14	15		SALEABLE		NOT AVAILABLE	NOT AVAILABLE		
KEY B, LIGHT GRAY, W/O CPA	34985-4064	B-LG	GC	PLR		M	R		2						10	11	12	13	14	15		SALEABLE		NOT AVAILABLE	NOT AVAILABLE		

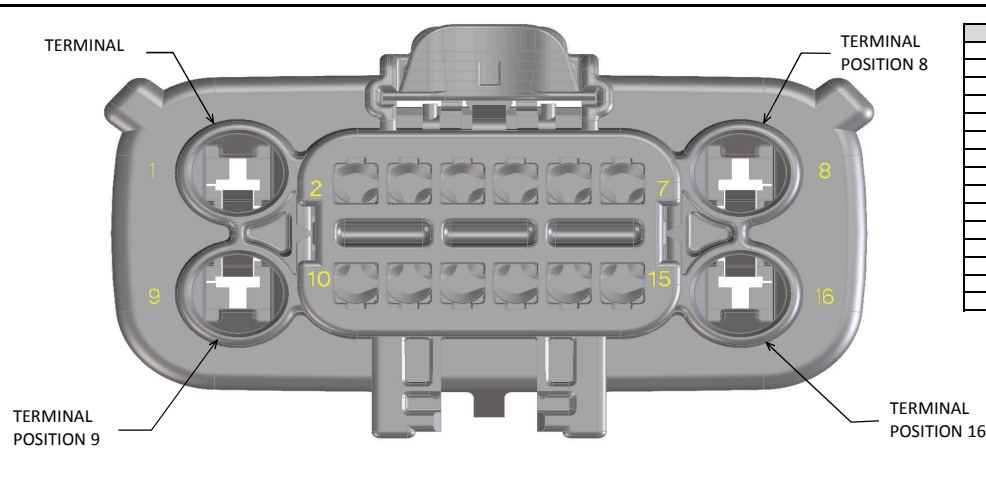
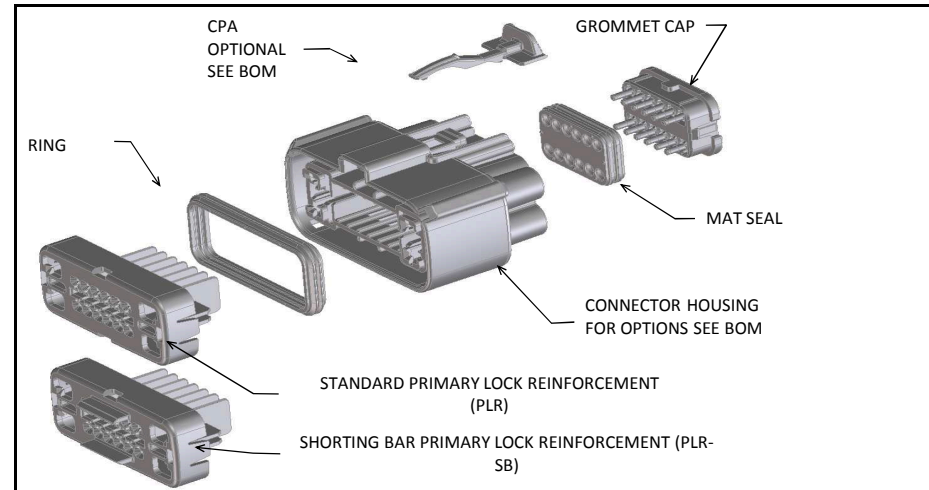

ABBREVIATION	DESCRIPTION	COLOR	MATERIAL
A-BLK-CLIP	HOUSING, KEYING OPTION A WITH CLIPSLOT	BLACK	SPS/NYLON GF20
B-LG-CLIP	HOUSING, KEYING OPTION B WITH CLIPSLOT	LIGHT GRAY	SPS/NYLON GF20
C-DG-CLIP	HOUSING, KEYING OPTION C WITH CLIPSLOT	DARK GRAY	SPS/NYLON GF20
D-SG-CLIP	HOUSING, KEYING OPTION D WITH CLIPSLOT	STONE GRAY	SPS/NYLON GF20
A-YW-CLIP	HOUSING, KEYING OPTION A WITH CLIPSLOT	YELLOW	SPS/NYLON GF20
E-BLK-CLIP	HOUSING, KEYING OPTION E WITH CLIPSLOT	BLACK	SPS/NYLON GF20
F-LG-CLIP	HOUSING, KEYING OPTION F WITH CLIPSLOT	LIGHT GRAY	SPS/NYLON GF20
G-DG-CLIP	HOUSING, KEYING OPTION G WITH CLIPSLOT	DARK GRAY	SPS/NYLON GF20
H-YW-CLIP	HOUSING, KEYING OPTION H WITH CLIPSLOT	YELLOW	SPS/NYLON GF20
GC	GROMMET CAP	BLACK	SPS/NYLON GF20
PLR	STANDARD PLR	NATURAL	SPS/NYLON GF20
PLR-SB	SHORTING BAR PLR	NATURAL	PBT GF15
CPA	CPA	RED	PBT GF20
M	MAT SEAL	ROYAL BLUE	INHERENTLY LUBRICATED SILICONE
R	RING SEAL	GREEN	INHERENTLY LUBRICATED SILICONE

FOR ADDITIONAL INFORMATION SEE SD-34985-8001

ASSEMBLY DESCRIPTION	ASSEMBLY PART NUMBER	COMPONENT						BLOCKED TERMINALS																STATUS	COMMENTS	OPTIONAL ATTACHMENTS SOLD SEPERATELY		
		THE PRESENCE OF AN ABBREVIATION INDICATES THE PRESENCE OF THAT COMPONENT.						CAVITY WITH A NUMBER INDICATES BLOCKED TERMINAL POSITION CAVITY WITHOUT A NUMBER INDICATES OPEN TERMINAL POSITION																		BACKSHELL WITH RIBS	BACKSHELL WITHOUT RIBS	
		HOUSING KEY/COLOR	GROMMET CAP	PLR	CPA	MAT SEAL	RING SEAL	1	2	3	4	5	6	7	8	9	10	11	12	13	14	15	16					
KEY E, BLACK, W/ CLIPSLOT, W/ SHRT BAR, W/O CPA	34985-1713	E-BLK-CLIP	GC	PLR-SB																					SALEABLE		NOT AVAILABLE	NOT AVAILABLE
KEY A, BLACK, W/ CLIPSLOT, W/O CPA	34985-1841	A-BLK-CLIP	GC	PLR																					SALEABLE		NOT AVAILABLE	NOT AVAILABLE
KEY A, BLACK, W/ CLIPSLOT, W/CPA	34985-1848	A-BLK-CLIP	GC	PLR	CPA				2																SALEABLE		NOT AVAILABLE	NOT AVAILABLE
KEY A, BLACK, W/ CLIPSLOT, W/O CPA	34985-1849	A-BLK-CLIP	GC	PLR																					SALEABLE		NOT AVAILABLE	NOT AVAILABLE
KEY A, BLACK, W/ CLIPSLOT, W/O CPA	34985-1850	A-BLK-CLIP	GC	PLR					2						7										SALEABLE		NOT AVAILABLE	NOT AVAILABLE
KEY F, LIGHT GRAY, W/ CLIPSLOT, W/ SHRT BAR, W/O CPA	34985-1851	F-LG-CLIP	GC	PLR-SB					2		3														SALEABLE		NOT AVAILABLE	NOT AVAILABLE
KEY F, LIGHT GRAY, W/ CLIPSLOT, W/ SHRT BAR, W/O CPA	34985-1852	F-LG-CLIP	GC	PLR-SB											6										SALEABLE		NOT AVAILABLE	NOT AVAILABLE
KEY F, LIGHT GRAY, W/ CLIPSLOT, W/ SHRT BAR, W/O CPA	34985-1853	F-LG-CLIP	GC	PLR-SB					2		3				6										SALEABLE		NOT AVAILABLE	NOT AVAILABLE
KEY F, LIGHT GRAY, W/ CLIPSLOT, W/ SHRT BAR, W/O CPA	34985-1854	F-LG-CLIP	GC	PLR-SB											6										SALEABLE		NOT AVAILABLE	NOT AVAILABLE
KEY F, LIGHT GRAY, W/ CLIPSLOT, W/ SHRT BAR, W/O CPA	34985-1855	F-LG-CLIP	GC	PLR-SB					2						6										SALEABLE		NOT AVAILABLE	NOT AVAILABLE
KEY F, LIGHT GRAY, W/ CLIPSLOT, W/ SHRT BAR, W/O CPA	34985-1856	F-LG-CLIP	GC	PLR-SB											6										SALEABLE		NOT AVAILABLE	NOT AVAILABLE
KEY F, LIGHT GRAY, W/ CLIPSLOT, W/ SHRT BAR, W/O CPA	34985-1857	F-LG-CLIP	GC	PLR-SB											6										SALEABLE		NOT AVAILABLE	NOT AVAILABLE
KEY F, LIGHT GRAY, W/ CLIPSLOT, W/ SHRT BAR, W/O CPA	34985-1858	F-LG-CLIP	GC	PLR-SB					2		3				6										SALEABLE		NOT AVAILABLE	NOT AVAILABLE
KEY F, LIGHT GRAY, W/ CLIPSLOT, W/ SHRT BAR, W/O CPA	34985-1859	F-LG-CLIP	GC	PLR-SB											6										SALEABLE		NOT AVAILABLE	NOT AVAILABLE
KEY F, LIGHT GRAY, W/ CLIPSLOT, W/ SHRT BAR, W/O CPA	34985-1860	F-LG-CLIP	GC	PLR-SB					2		3				6										SALEABLE		NOT AVAILABLE	NOT AVAILABLE
KEY A, BLACK, W/ CLIPSLOT, W/O CPA	34985-1861	A-BLK-CLIP	GC	PLR					2		3				4										SALEABLE		NOT AVAILABLE	NOT AVAILABLE
KEY E, BLACK, W/ CLIPSLOT, W/ SHRT BAR, W/O CPA	34985-1862	E-BLK-CLIP	GC	PLR-SB					2		3				4										SALEABLE		NOT AVAILABLE	NOT AVAILABLE
KEY E, BLACK, W/ CLIPSLOT, W/ SHRT BAR, W/O CPA	34985-1875	E-BLK-CLIP	GC	PLR-SB																					SALEABLE		NOT AVAILABLE	NOT AVAILABLE
KEY E, BLACK, W/ CLIPSLOT, W/ SHRT BAR, W/O CPA	34985-1876	E-BLK-CLIP	GC	PLR-SB																					SALEABLE		NOT AVAILABLE	NOT AVAILABLE
KEY E, BLACK, W/ CLIPSLOT, W/ SHRT BAR, W/O CPA	34985-1877	E-BLK-CLIP	GC	PLR-SB																					SALEABLE		NOT AVAILABLE	NOT AVAILABLE
KEY E, BLACK, W/ CLIPSLOT, W/ SHRT BAR, W/O CPA	34985-1878	E-BLK-CLIP	GC	PLR-SB																					SALEABLE		NOT AVAILABLE	NOT AVAILABLE
KEY A, BLACK, W/ CLIPSLOT, W/O CPA	34985-1881	A-BLK-CLIP	GC	PLR																					SALEABLE		NOT AVAILABLE	NOT AVAILABLE
KEY A, BLACK, W/ CLIPSLOT, W/O CPA	34985-1891	A-BLK-CLIP	GC	PLR					2		3				6										SALEABLE		NOT AVAILABLE	NOT AVAILABLE
KEY E, BLACK, W/ CLIPSLOT, W/ SHRT BAR, W/O CPA	34985-1892	E-BLK-CLIP	GC	PLR-SB					2		3				6										SALEABLE		NOT AVAILABLE	NOT AVAILABLE
KEY E, BLACK, W/ CLIPSLOT, W/ SHRT BAR, W/O CPA	34985-1893	E-BLK-CLIP	GC	PLR-SB											6										SALEABLE		NOT AVAILABLE	NOT AVAILABLE
KEY F, LIGHT GRAY, W/ CLIPSLOT, W/ SHRT BAR, W/O CPA	34985-1894	F-LG-CLIP	GC	PLR-SB																					SALEABLE		NOT AVAILABLE	NOT AVAILABLE
KEY H, YELLOW, W/ CLIPSLOT, W/ SHRT BAR, W/O CPA	34985-1895	H-YW-CLIP	GC	PLR-SB																					SALEABLE		NOT AVAILABLE	NOT AVAILABLE
KEY H, YELLOW, W/ CLIPSLOT, W/ SHRT BAR, W/O CPA	34985-1896	H-YW-CLIP	GC	PLR-SB																					SALEABLE		NOT AVAILABLE	NOT AVAILABLE
KEY F, LIGHT GRAY, W/ CLIPSLOT, W/ SHRT BAR, W/O CPA	34985-1897	F-LG-CLIP	GC	PLR-SB											6										SALEABLE		NOT AVAILABLE	NOT AVAILABLE
KEY F, LIGHT GRAY, W/ CLIPSLOT, W/ SHRT BAR, W/O CPA	34985-1898	F-LG-CLIP	GC	PLR-SB											6										SALEABLE		NOT AVAILABLE	NOT AVAILABLE
KEY H, YELLOW, W/ CLIPSLOT, W/ SHRT BAR, W/O CPA	34985-1899	H-YW-CLIP	GC	PLR-SB											6										SALEABLE		NOT AVAILABLE	NOT AVAILABLE
KEY H, YELLOW, W/ CLIPSLOT, W/ SHRT BAR, W/O CPA	34985-1900	H-YW-CLIP	GC	PLR-SB											6										SALEABLE		NOT AVAILABLE	NOT AVAILABLE
KEY A, BLACK, W/ CLIPSLOT, W/O CPA	34985-1909	A-BLK-CLIP	GC	PLR					2		3														SALEABLE		NOT AVAILABLE	NOT AVAILABLE
KEY A, BLACK, W/ CLIPSLOT, W/O CPA	34985-1910	A-BLK-CLIP	GC	PLR					2																SALEABLE		NOT AVAILABLE	NOT AVAILABLE
KEY A, BLACK, W/ CLIPSLOT, W/O CPA	34985-1911	A-BLK-CLIP	GC	PLR					2																SALEABLE		NOT AVAILABLE	NOT AVAILABLE
KEY A, BLACK, W/ CLIPSLOT, W/O CPA	34985-1912	A-BLK-CLIP	GC	PLR					2		3														SALEABLE		NOT AVAILABLE	NOT AVAILABLE
KEY A, BLACK, W/ CLIPSLOT, W/O CPA	34985-1913	A-BLK-CLIP	GC	PLR					2		3														SALEABLE		NOT AVAILABLE	NOT AVAILABLE
KEY A, BLACK, W/ CLIPSLOT, W/O CPA	34985-1914	A-BLK-CLIP	GC	PLR																					SALEABLE		NOT AVAILABLE	NOT AVAILABLE
KEY A, BLACK, W/ CLIPSLOT, W/O CPA	34985-1917	A-BLK-CLIP	GC	PLR					2																SALEABLE		NOT AVAILABLE	NOT AVAILABLE
KEY A, BLACK, W/ CLIPSLOT, W/O CPA	34985-1919	A-BLK-CLIP	GC	PLR																					SALEABLE		NOT AVAILABLE	NOT AVAILABLE
KEY A, BLACK, W/ CLIPSLOT, W/O CPA	34985-1920	A-BLK-CLIP	GC	PLR																					SALEABLE		NOT AVAILABLE	NOT AVAILABLE
KEY A, BLACK, W/ CLIPSLOT, W/O CPA	34985-1921	A-BLK-CLIP	GC	PLR																					SALEABLE		NOT AVAILABLE	NOT AVAILABLE
KEY A, BLACK, W/ CLIPSLOT, W/O CPA	34985-1922	A-BLK-CLIP	GC	PLR					2																SALEABLE		NOT AVAILABLE	NOT AVAILABLE
KEY A, BLACK, W/ CLIPSLOT, W/O CPA	34985-1923	A-BLK-CLIP	GC	PLR																					SALEABLE		NOT AVAILABLE	NOT AVAILABLE
KEY A, BLACK, W/ CLIPSLOT, W/O CPA	34985-1935	A-BLK-CLIP	GC	PLR					2		3														SALEABLE		NOT AVAILABLE	NOT AVAILABLE
KEY A, BLACK, W/ CLIPSLOT, W/O CPA	34985-1945	A-BLK-CLIP	GC	PLR																					SALEABLE		NOT AVAILABLE	NOT AVAILABLE
KEY A, BLACK, W/ CLIPSLOT, W/O CPA	34985-1948	A-BLK-CLIP	GC	PLR					2																SALEABLE		NOT AVAILABLE	NOT AVAILABLE
KEY A, BLACK, W/ CLIPSLOT, W/O CPA	34985-1953	A-BLK-CLIP	GC	PLR					2																SALEABLE		NOT AVAILABLE	NOT AVAILABLE
KEY A, BLACK, W/ CLIPSLOT, W/O CPA	34985-1954	A-BLK-CLIP	GC	PLR											6										SALEABLE		NOT AVAILABLE	NOT AVAILABLE
KEY H, YELLOW, W/ CLIPSLOT, W/ SHRT BAR, W/CPA	34985-1955	H-YW-CLIP	GC	PLR-SB	CPA										6										SALEABLE		NOT AVAILABLE	NOT AVAILABLE
KEY A, BLACK, W/ CLIPSLOT, W/O CPA	34985-1958	A-BLK-CLIP	GC	PLR					2																SALEABLE		NOT AVAILABLE	NOT AVAILABLE
KEY A, BLACK, W/ CLIPSLOT, W/O CPA	34985-1959	A-BLK-CLIP	GC	PLR																					SALEABLE		NOT AVAILABLE	NOT AVAILABLE
KEY A, BLACK, W/ CLIPSLOT, W/O CPA</																												

MX150 16 WAY HYBRID RECEPTACLE SEALED ASSEMBLY MAT SEAL (WITH CLIPSLOT, 2.8mm CAVITIES OPEN)
BOM AND PIN OUT SHEET

Table with columns: ASSEMBLY DESCRIPTION, ASSEMBLY PART NUMBER, COMPONENT (HOUSING KEY/COLOR, GROMMET CAP, PLR, CPA, MAT SEAL, RING SEAL), BLOCKED TERMINALS (1-16), STATUS, COMMENTS, and OPTIONAL ATTACHMENTS SOLD SEPARATELY (BACKSHELL WITH RIBS, BACKSHELL WITHOUT RIBS).

MX150 16 WAY HYBRID RECEPTACLE SEALED ASSEMBLY MAT SEAL (WITH CLIPSLOT, 2.8mm CAVITIES OPEN)
BOM AND PIN OUT SHEET

Table with columns: ASSEMBLY DESCRIPTION, ASSEMBLY PART NUMBER, COMPONENT (HOUSING KEY/COLOR, GROMMET CAP, PLR, CPA, MAT SEAL, RING SEAL), BLOCKED TERMINALS (1-16), STATUS, COMMENTS, and OPTIONAL ATTACHMENTS SOLD SEPARATELY (BACKSHELL WITH RIBS, BACKSHELL WITHOUT RIBS).