



Chipsmall Limited consists of a professional team with an average of over 10 year of expertise in the distribution of electronic components. Based in Hongkong, we have already established firm and mutual-benefit business relationships with customers from,Europe,America and south Asia,supplying obsolete and hard-to-find components to meet their specific needs.

With the principle of “Quality Parts,Customers Priority,Honest Operation,and Considerate Service”,our business mainly focus on the distribution of electronic components. Line cards we deal with include Microchip,ALPS,ROHM,Xilinx,Pulse,ON,Everlight and Freescale. Main products comprise IC,Modules,Potentiometer,IC Socket,Relay,Connector.Our parts cover such applications as commercial,industrial, and automotives areas.

We are looking forward to setting up business relationship with you and hope to provide you with the best service and solution. Let us make a better world for our industry!



## Contact us

Tel: +86-755-8981 8866 Fax: +86-755-8427 6832

Email & Skype: info@chipsmall.com Web: www.chipsmall.com

Address: A1208, Overseas Decoration Building, #122 Zhenhua RD., Futian, Shenzhen, China



## 74ALVC162601

### Low Voltage 18-Bit Universal Bus Transceivers with 3.6V Tolerant Inputs and Outputs and 26Ω Series Resistors in the B-Port Outputs

#### General Description

The 74ALVC162601, 18-bit universal bus transceiver, combines D-type latches and D-type flip-flops to allow data flow in transparent, latched, and clocked modes.

Data flow in each direction is controlled by output-enable ( $\overline{OEAB}$  and  $\overline{OEBA}$ ), latch-enable (LEAB and LEBA), and clock (CLKAB and CLKBA) inputs. The clock can be controlled by the clock-enable (CLKENAB and CLKENBA) inputs. For A-to-B data flow, the device operates in the transparent mode when LEAB is HIGH. When LEAB is LOW, the A data is latched if CLKAB is held at a HIGH-to-LOW logic level. If LEAB is LOW, the A bus data is stored in the latch/flip-flop on the LOW-to-HIGH transition of CLKAB. Output-enable  $\overline{OEAB}$  is active-LOW. When  $\overline{OEAB}$  is HIGH, the outputs are in the HIGH-impedance state.

Data flow for B to A is similar to that of A to B but uses  $\overline{OEBA}$ , LEBA, CLKBA and CLKENBA.

The 74ALVC162601 is designed for low voltage (1.65V to 3.6V)  $V_{CC}$  applications with I/O compatibility up to 3.6V. The 74ALVC162601 is also designed with 26Ω series resistors in the B-Port outputs. This design reduces line noise in applications such as memory address drivers, clock drivers, and bus transceivers/transmitters.

#### Features

- 1.65V–3.6V  $V_{CC}$  supply operation
- 3.6V tolerant inputs and outputs
- 26Ω series resistors in B-Port outputs
- $t_{PD}$  (A to B)
  - 4.3 ns max for 3.0V to 3.6V  $V_{CC}$
  - 5.1 ns max for 2.3V to 2.7V  $V_{CC}$
  - 9.2 ns max for 1.65V to 1.95V  $V_{CC}$
- Power-down high impedance inputs and outputs
- Supports live insertion/withdrawal (Note 1)
- Uses patented noise/EMI reduction circuitry
- Latchup conforms to JEDEC JED78
- ESD performance:
  - Human body model > 2000V
  - Machine model >200V

**Note 1:** To ensure the high-impedance state during power up or power down,  $\overline{OE}$  should be tied to  $V_{CC}$  through a pull-up resistor; the minimum value of the resistor is determined by the current-sourcing capability of the driver.

#### Ordering Code:

Order Number	Package Number	Package Description
74ALVC162601T	MTD56	56-Lead Thin Shrink Small Outline Package (TSSOP), JEDEC MO-153, 6.1mm Wide

Devices also available in Tape and Reel. Specify by appending the suffix letter "X" to the ordering code.

74ALVC162601 Low Voltage 18-Bit Universal Bus Transceivers with 3.6V Tolerant Inputs and Outputs and 26Ω Series Resistors in the B-Port Outputs

### Pin Descriptions

Pin Names	Description
$\overline{OEAB}$ , $\overline{OEBA}$	Output Enable Inputs (Active LOW)
LEAB, LEBA	Latch Enable Inputs
CLKAB, CLKBA	Clock Inputs
$\overline{CLKENAB}$ , $\overline{CLKENBA}$	Clock Enable Inputs
A <sub>1</sub> -A <sub>18</sub>	Side A Inputs or 3-STATE Outputs
B <sub>1</sub> -B <sub>18</sub>	Side B Inputs or 3-STATE Outputs

### Connection Diagram

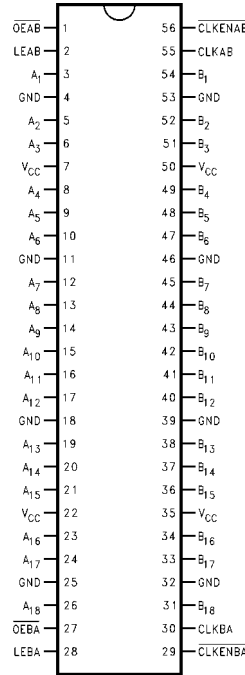

### Function Table (Note 2)

Inputs				Outputs	
$\overline{CLKENAB}$	$\overline{OEAB}$	LEAB	CLKAB	A <sub>n</sub>	B <sub>n</sub>
X	H	X	X	X	Z
X	L	H	X	L	L
X	L	H	X	H	H
H	L	L	X	X	B <sub>0</sub> (Note 3)
H	L	L	X	X	B <sub>0</sub> (Note 3)
L	L	L	↑	L	L
L	L	L	↑	H	H
L	L	L	L	X	B <sub>0</sub> (Note 3)
L	L	L	H	X	B <sub>0</sub> (Note 4)

H = HIGH Voltage Level  
 L = LOW Voltage Level  
 X = Immaterial (HIGH or LOW, inputs may not float)  
 Z = High Impedance

**Note 2:** A-to-B data flow is shown; B-to-A flow is similar but uses  $\overline{OEBA}$ , LEBA, CLKBA, and  $\overline{CLKENBA}$ .

**Note 3:** Output level before the indicated steady-state input conditions were established.

**Note 4:** Output level before the indicated steady-state input conditions were established, provided that CLKAB was HIGH before LEAB went LOW.

### Logic Diagram

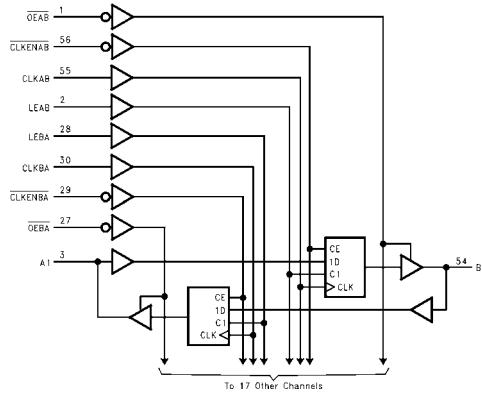

**Absolute Maximum Ratings** (Note 5)

Supply Voltage ( $V_{CC}$ )	-0.5V to +4.6V
DC Input Voltage ( $V_I$ )	-0.5V to 4.6V
Output Voltage ( $V_O$ ) (Note 6)	-0.5V to $V_{CC} + 0.5V$
DC Input Diode Current ( $I_{IK}$ )	
$V_I < 0V$	-50 mA
DC Output Diode Current ( $I_{OK}$ )	
$V_O < 0V$	-50 mA
DC Output Source/Sink Current ( $I_{OH}/I_{OL}$ )	$\pm 50$ mA
DC $V_{CC}$ or GND Current per Supply Pin ( $I_{CC}$ or GND)	$\pm 100$ mA
Storage Temperature Range ( $T_{STG}$ )	-65°C to +150°C

**Recommended Operating Conditions** (Note 7)

Power Supply	
Operating	1.65V to 3.6V
Input Voltage	0V to $V_{CC}$
Output Voltage ( $V_O$ )	0V to $V_{CC}$
Free Air Operating Temperature ( $T_A$ )	-40°C to +85°C
Minimum Input Edge Rate ( $\Delta t/\Delta V$ )	
$V_{IN} = 0.8V$ to 2.0V, $V_{CC} = 3.0V$	10 ns/V

**Note 5:** The Absolute Maximum Ratings are those values beyond which the safety of the device cannot be guaranteed. The device should not be operated at these limits. The parametric values defined in the Electrical Characteristics tables are not guaranteed at the Absolute Maximum Ratings. The "Recommended Operating Conditions" table will define the conditions for actual device operation.

**Note 6:**  $I_O$  Absolute Maximum Rating must be observed.

**Note 7:** Floating or unused control inputs must be held HIGH or LOW.

**DC Electrical Characteristics**

Symbol	Parameter	Conditions	$V_{CC}$ (V)	Min	Max	Units
$V_{IH}$	HIGH Level Input Voltage		1.65 - 1.95 2.3 - 2.7 2.7 - 3.6	$0.65 \times V_{CC}$ 1.7 2.0		V
$V_{IL}$	LOW Level Input Voltage		1.65 - 1.95 2.3 - 2.7 2.7 - 3.6		$0.35 \times V_{CC}$ 0.7 0.8	V
$V_{OH}$	HIGH Level Output Voltage A Outputs	$I_{OH} = -100 \mu A$	1.65 - 3.6	$V_{CC} - 0.2$		V
		$I_{OH} = -4$ mA	1.65	1.2		
		$I_{OH} = -6$ mA	2.3	2.0		
		$I_{OH} = -12$ mA	2.3	1.7		
			2.7	2.2		
			3.0	2.4		
	HIGH Level Output Voltage B Outputs	$I_{OH} = -100 \mu A$	1.65 - 3.6	$V_{CC} - 0.2$		
		$I_{OH} = -2$ mA	1.65	1.2		
		$I_{OH} = -4$ mA	2.3	1.9		
		$I_{OH} = -6$ mA	2.3	1.7		
			3.0	2.4		
		$I_{OH} = -8$ mA	2.7	2		
$V_{OL}$	LOW Level Output Voltage A Outputs	$I_{OL} = 100 \mu A$	1.65 - 3.6		0.2	V
		$I_{OL} = 4$ mA	1.65		0.45	
		$I_{OL} = 6$ mA	2.3		0.4	
		$I_{OL} = 12$ mA	2.3		0.7	
			2.7		0.4	
		$I_{OL} = 24$ mA	3.0		0.55	
	LOW Level Output Voltage B Outputs	$I_{OL} = 100 \mu A$	1.65 - 3.6		0.2	
		$I_{OL} = 2$ mA	1.65		0.45	
		$I_{OL} = 4$ mA	2.3		0.4	
		$I_{OL} = 6$ mA	2.3		0.55	
			3.0		0.55	
		$I_{OL} = 8$ mA	2.7		0.6	
	3.0		0.8			

## DC Electrical Characteristics (Continued)

Symbol	Parameter	Conditions	V <sub>CC</sub> (V)	Min	Max	Units	
I <sub>OH</sub>	High Level Output Current A Outputs		1.65		-4	mA	
			2.3		-12		
			2.7		-12		
			3.0		-24		
	High Level Output Current B Outputs		1.65		-2		
			2.3		-6		
			2.7		-8		
			3.0		-12		
I <sub>OL</sub>	Low Level Output Current A Outputs		1.65		4	mA	
			2.3		12		
			2.7		12		
			3		24		
		Low Level Output Current B Outputs		1.65			2
				2.3			6
				2.7			8
				3.0			12
I <sub>I</sub>	Input Leakage Current	0 ≤ V <sub>I</sub> ≤ 3.6V	1.65 - 3.6		±5.0	μA	
I <sub>OZ</sub>	3-STATE Output Leakage	0 ≤ V <sub>O</sub> ≤ 3.6V, V <sub>I</sub> = V <sub>IH</sub> or V <sub>IL</sub>	1.65 - 3.6		±10	μA	
I <sub>OFF</sub>	Power Off Leakage Current	0V ≤ (V <sub>I</sub> , V <sub>O</sub> ) ≤ 3.6V	0		10	mA	
I <sub>CC</sub>	Quiescent Supply Current	V <sub>I</sub> = V <sub>CC</sub> or GND, I <sub>O</sub> = 0	3.6		40	μA	
ΔI <sub>CC</sub>	Increase in I <sub>CC</sub> per Input	V <sub>IH</sub> = V <sub>CC</sub> - 0.6V	2.7 - 3.6		750	μA	

## AC Electrical Characteristics

Symbol	Parameter	T <sub>A</sub> = -40°C to +85°C, R <sub>L</sub> = 500Ω								Units
		C <sub>L</sub> = 50 pF				C <sub>L</sub> = 30 pF				
		V <sub>CC</sub> = 3.3V ± 0.3V		V <sub>CC</sub> = 2.7V		V <sub>CC</sub> = 2.5 ± 0.2V		V <sub>CC</sub> = 1.8V ± 0.15V		
		Min	Max	Min	Max	Min	Max	Min	Max	
f <sub>MAX</sub>	Maximum Clock Frequency	250		200		200		125		MHz
t <sub>PHL</sub> , t <sub>PLH</sub>	Propagation Delay A to B	1.3	4.3	1.5	5.1	1	4.6	1.5	9.2	ns
	Propagation Delay B to A	1.3	3.4	1.5	4.0	1	3.5	1.5	7.0	
t <sub>PHL</sub> , t <sub>PLH</sub>	Propagation Delay Clock to A	1.3	4.0	1.5	4.9	1.0	4.4	1.5	8.8	ns
	Propagation Delay Clock to B	1.3	4.9	1.5	6.0	1.0	5.5	1.5	9.8	
t <sub>PHL</sub> , t <sub>PLH</sub>	Propagation Delay LEBA to A	1.3	4.0	1.5	4.9	1.0	4.4	1.5	8.8	ns
	Propagation Delay LEAB to B	1.3	4.9	1.5	6.3	1.0	5.8	1.5	9.8	
t <sub>PZL</sub> , t <sub>PZH</sub>	Output Enable Time OEBA to A	1.3	4.3	1.5	5.4	1.0	4.9	1.5	9.8	ns
	Output Enable Time OEAB to B	1.3	4.8	1.5	6.4	1.0	5.9	1.5	9.8	

AC Electrical Characteristics (Continued)										
Symbol	Parameter	$T_A = -40^\circ\text{C to } +85^\circ\text{C}, R_L = 500\Omega$								Units
		$C_L = 50\text{ pF}$				$C_L = 30\text{ pF}$				
		$V_{CC} = 3.3V \pm 0.3V$		$V_{CC} = 2.7V$		$V_{CC} = 2.5 \pm 0.2V$		$V_{CC} = 1.8V \pm 0.15V$		
		Min	Max	Min	Max	Min	Max	Min	Max	
$t_{PLZ}, t_{PHZ}$	Output Disable Time $\overline{OEBA}$ to A	1.3	4.2	1.5	4.7	1.0	4.2	1.5	7.6	ns
	Output Disable Time $\overline{OEAB}$ to B	1.3	4.8	1.5	5.4	1.0	4.9	1.5	8.8	
Symbol	Parameter	$T_A = -40^\circ\text{C to } +85^\circ\text{C}, R_L = 500\Omega$								Units
		$C_L = 50\text{ pF}$				$C_L = 30\text{ pF}$				
		$V_{CC} = 3.3V \pm 0.3V$		$V_{CC} = 2.7V$		$V_{CC} = 2.5 \pm 0.2V$		$V_{CC} = 1.8V \pm 0.15V$		
		Min	Max	Min	Max	Min	Max	Min	Max	
$t_S$	Setup Time	1.5		1.5		1.5		2.5		ns
$t_H$	Hold Time	1.0		1.0		1.0		1.0		ns
$t_W$	Pulse Width	1.5		1.5		1.5		4.0		ns
Capacitance										
Symbol	Parameter	Conditions	$T_A = +25^\circ\text{C}$		Units					
			$V_{CC}$	Typical						
$C_{IN}$	Input Capacitance	$V_i = 0V$ or $V_{CC}$	3.3	6	pF					
$C_{OUT}$	Output Capacitance	$V_i = 0V$ or $V_{CC}$	3.3	7	pF					
$C_{PD}$	Power Dissipation Capacitance	Outputs Enabled	$f = 10\text{ MHz}, C_L = 0\text{ pF}$	3.3	20	pF				
				2.5	20					

## AC Loading and Waveforms

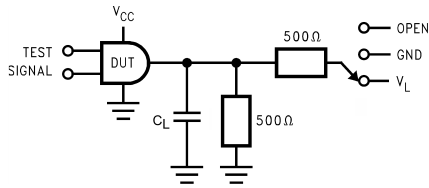

FIGURE 1. AC Test Circuit

Table 1: Values for Figure 1

TEST	SWITCH
$t_{PLH}$ , $t_{PHL}$	Open
$t_{PZL}$ , $t_{PLZ}$	$V_L$
$t_{PZH}$ , $t_{PHZ}$	GND

Table 2: Variable Matrix  
( Input Characteristics:  $f = 1\text{MHz}$ ;  $t_r=t_f=2\text{ns}$ ;  $Z_0 = 50\Omega$  )

Symbol	$V_{CC}$			
	$3.3\text{V} \pm 0.3\text{V}$	2.7V	$2.5\text{V} \pm 0.2\text{V}$	$1.8\text{V} \pm 0.15\text{V}$
$V_{mi}$	1.5V	1.5V	$V_{CC}/2$	$V_{CC}/2$
$V_{mo}$	1.5V	1.5V	$V_{CC}/2$	$V_{CC}/2$
$V_X$	$V_{OL} + 0.3\text{V}$	$V_{OL} + 0.3\text{V}$	$V_{OL} + 0.15\text{V}$	$V_{OL} + 0.15\text{V}$
$V_Y$	$V_{OH} - 0.3\text{V}$	$V_{OH} - 0.3\text{V}$	$V_{OH} - 0.15\text{V}$	$V_{OH} - 0.15\text{V}$
$V_L$	6V	6V	$V_{CC} * 2$	$V_{CC} * 2$

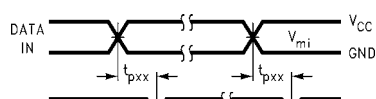

FIGURE 2. Waveform for Inverting and Non-inverting Functions

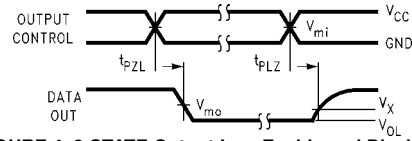

FIGURE 4. 3-STATE Output Low Enable and Disable Times for Low Voltage Logic

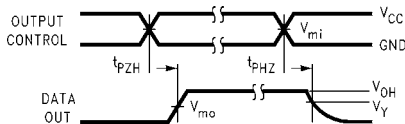

FIGURE 3. 3-STATE Output High Enable and Disable Times for Low Voltage Logic

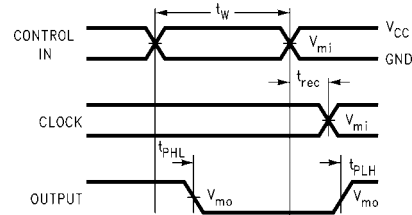

FIGURE 5. Propagation Delay, Pulse Width and  $t_{rec}$  Waveforms

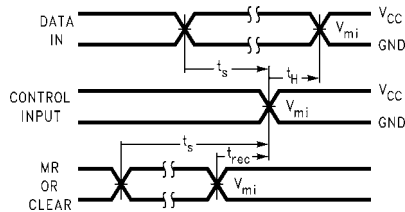
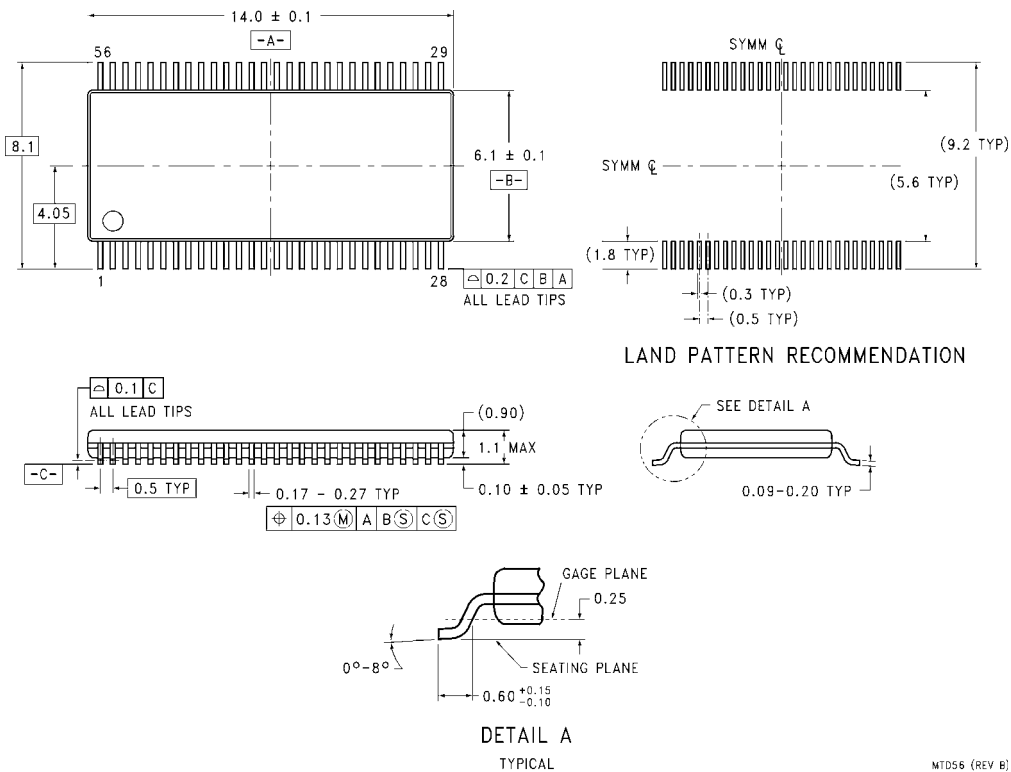

FIGURE 6. Setup Time, Hold Time and Recovery Time for Low Voltage Logic

**Physical Dimensions** inches (millimeters) unless otherwise noted



**56-Lead Thin Shrink Small Outline Package (TSSOP), JEDEC MO-153, 6.1mm Wide  
Package Number MTD56**

MTD56 (REV B)

Fairchild does not assume any responsibility for use of any circuitry described, no circuit patent licenses are implied and Fairchild reserves the right at any time without notice to change said circuitry and specifications.

**LIFE SUPPORT POLICY**

FAIRCHILD'S PRODUCTS ARE NOT AUTHORIZED FOR USE AS CRITICAL COMPONENTS IN LIFE SUPPORT DEVICES OR SYSTEMS WITHOUT THE EXPRESS WRITTEN APPROVAL OF THE PRESIDENT OF FAIRCHILD SEMICONDUCTOR CORPORATION. As used herein:

1. Life support devices or systems are devices or systems which, (a) are intended for surgical implant into the body, or (b) support or sustain life, and (c) whose failure to perform when properly used in accordance with instructions for use provided in the labeling, can be reasonably expected to result in a significant injury to the user.
2. A critical component in any component of a life support device or system whose failure to perform can be reasonably expected to cause the failure of the life support device or system, or to affect its safety or effectiveness.

[www.fairchildsemi.com](http://www.fairchildsemi.com)