



Chipsmall Limited consists of a professional team with an average of over 10 year of expertise in the distribution of electronic components. Based in Hongkong, we have already established firm and mutual-benefit business relationships with customers from,Europe,America and south Asia,supplying obsolete and hard-to-find components to meet their specific needs.

With the principle of "Quality Parts,Customers Priority,Honest Operation,and Considerate Service",our business mainly focus on the distribution of electronic components. Line cards we deal with include Microchip,ALPS,ROHM,Xilinx,Pulse,ON,Everlight and Freescale. Main products comprise IC,Modules,Potentiometer,IC Socket,Relay,Connector.Our parts cover such applications as commercial,industrial, and automotives areas.

We are looking forward to setting up business relationship with you and hope to provide you with the best service and solution. Let us make a better world for our industry!



Contact us

Tel: +86-755-8981 8866 Fax: +86-755-8427 6832

Email & Skype: info@chipsmall.com Web: www.chipsmall.com

Address: A1208, Overseas Decoration Building, #122 Zhenhua RD., Futian, Shenzhen, China



Important notice

Dear Customer,

On 7 February 2017 the former NXP Standard Product business became a new company with the tradename **Nexperia**. Nexperia is an industry leading supplier of Discrete, Logic and PowerMOS semiconductors with its focus on the automotive, industrial, computing, consumer and wearable application markets

In data sheets and application notes which still contain NXP or Philips Semiconductors references, use the references to Nexperia, as shown below.

Instead of <http://www.nxp.com>, <http://www.philips.com/> or <http://www.semiconductors.philips.com/>, use <http://www.nexperia.com>

Instead of sales.addresses@www.nxp.com or sales.addresses@www.semiconductors.philips.com, use salesaddresses@nexperia.com (email)

Replace the copyright notice at the bottom of each page or elsewhere in the document, depending on the version, as shown below:

- © NXP N.V. (year). All rights reserved or © Koninklijke Philips Electronics N.V. (year). All rights reserved

Should be replaced with:

- © **Nexperia B.V. (year). All rights reserved.**

If you have any questions related to the data sheet, please contact our nearest sales office via e-mail or telephone (details via salesaddresses@nexperia.com). Thank you for your cooperation and understanding,

Kind regards,

Team Nexperia

74AUP1G125

Low-power buffer/line driver; 3-state

Rev. 6 — 15 August 2012

Product data sheet

1. General description

The 74AUP1G125 provides a single non-inverting buffer/line driver with 3-state output. The 3-state output is controlled by the output enable input (\overline{OE}). A HIGH level at pin \overline{OE} causes the output to assume a high-impedance OFF-state. This device has the input-disable feature, which allows floating input signals. The inputs are disabled when the output enable input (\overline{OE}) is HIGH.

Schmitt-trigger action at all inputs makes the circuit tolerant to slower input rise and fall times across the entire V_{CC} range from 0.8 V to 3.6 V. This device ensures a very low static and dynamic power consumption across the entire V_{CC} range from 0.8 V to 3.6 V.

This device is fully specified for partial power-down applications using I_{OFF} . The I_{OFF} circuitry disables the output, preventing a damaging backflow current through the device when it is powered down.

2. Features and benefits

- Wide supply voltage range from 0.8 V to 3.6 V
- High noise immunity
- Complies with JEDEC standards:
 - ◆ JESD8-12 (0.8 V to 1.3 V)
 - ◆ JESD8-11 (0.9 V to 1.65 V)
 - ◆ JESD8-7 (1.2 V to 1.95 V)
 - ◆ JESD8-5 (1.8 V to 2.7 V)
 - ◆ JESD8-B (2.7 V to 3.6 V)
- ESD protection:
 - ◆ HBM JESD22-A114F Class 3A exceeds 5000 V
 - ◆ MM JESD22-A115-A exceeds 200 V
 - ◆ CDM JESD22-C101E exceeds 1000 V
- Low static power consumption; $I_{CC} = 0.9 \mu\text{A}$ (maximum)
- Latch-up performance exceeds 100 mA per JESD 78 Class II
- Inputs accept voltages up to 3.6 V
- Low noise overshoot and undershoot < 10 % of V_{CC}
- Input-disable feature allows floating input conditions
- I_{OFF} circuitry provides partial Power-down mode operation
- Multiple package options
- Specified from $-40 \text{ }^\circ\text{C}$ to $+85 \text{ }^\circ\text{C}$ and $-40 \text{ }^\circ\text{C}$ to $+125 \text{ }^\circ\text{C}$



3. Ordering information

Table 1. Ordering information

Type number	Package			Version
	Temperature range	Name	Description	
74AUP1G125GW	-40 °C to +125 °C	TSSOP5	plastic thin shrink small outline package; 5 leads; body width 1.25 mm	SOT353-1
74AUP1G125GM	-40 °C to +125 °C	XSON6	plastic extremely thin small outline package; no leads; 6 terminals; body 1 × 1.45 × 0.5 mm	SOT886
74AUP1G125GF	-40 °C to +125 °C	XSON6	plastic extremely thin small outline package; no leads; 6 terminals; body 1 × 1 × 0.5 mm	SOT891
74AUP1G125GN	-40 °C to +125 °C	XSON6	extremely thin small outline package; no leads; 6 terminals; body 0.9 × 1.0 × 0.35 mm	SOT1115
74AUP1G125GS	-40 °C to +125 °C	XSON6	extremely thin small outline package; no leads; 6 terminals; body 1.0 × 1.0 × 0.35 mm	SOT1202
74AUP1G125GX	-40 °C to +125 °C	X2SON5	X2SON5: plastic thermal enhanced extremely thin small outline package; no leads; 5 terminals; body 0.8 × 0.8 × 0.35 mm	SOT1226

4. Marking

Table 2. Marking

Type number	Marking code ^[1]
74AUP1G125GW	pM
74AUP1G125GM	pM
74AUP1G125GF	pM
74AUP1G125GN	pM
74AUP1G125GS	pM
74AUP1G125GX	pM

[1] The pin 1 indicator is located on the lower left corner of the device, below the marking code.

5. Functional diagram

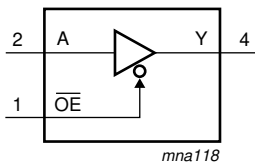
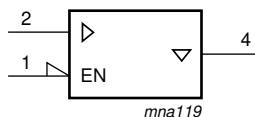
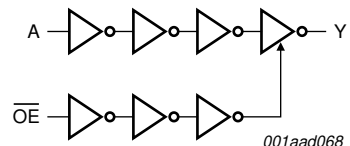
 <p>Fig 1. Logic symbol</p>	 <p>Fig 2. IEC logic symbol</p>	 <p>Fig 3. Logic diagram</p>
---	---	--

6. Pinning information

6.1 Pinning

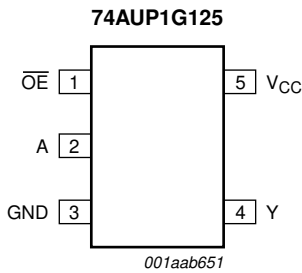

Fig 4. Pin configuration SOT353-1

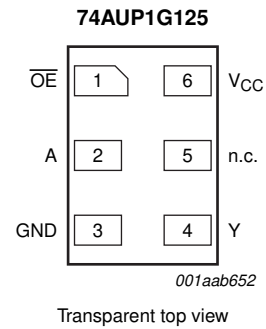

Fig 5. Pin configuration SOT886

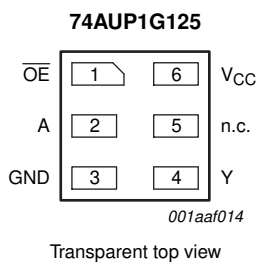

Fig 6. Pin configuration SOT891, SOT1115 and SOT1202

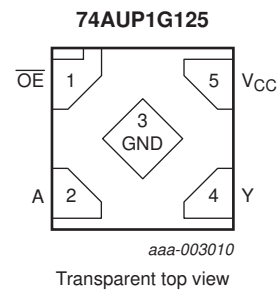

Fig 7. Pin configuration SOT1226 (X2SON5)

6.2 Pin description

Table 3. Pin description

Symbol	Pin		Description
	TSSOP5 and X2SON5	XSON6	
\overline{OE}	1	1	output enable input
A	2	2	data input
GND	3	3	ground (0 V)
Y	4	4	data output
n.c.	-	5	not connected
V _{CC}	5	6	supply voltage

7. Functional description

Table 4. Function table^[1]

Input		Output
OE	A	Y
L	L	L
L	H	H
H	X	Z

- [1] H = HIGH voltage level;
 L = LOW voltage level;
 X = Don't care;
 Z = high-impedance OFF-state.

8. Limiting values

Table 5. Limiting values

In accordance with the Absolute Maximum Rating System (IEC 60134). Voltages are referenced to GND (ground = 0 V).

Symbol	Parameter	Conditions	Min	Max	Unit
V_{CC}	supply voltage		-0.5	+4.6	V
I_{IK}	input clamping current	$V_I < 0$ V	-50	-	mA
V_I	input voltage		[1] -0.5	+4.6	V
I_{OK}	output clamping current	$V_O < 0$ V	-50	-	mA
V_O	output voltage	Active mode	[1] -0.5	$V_{CC} + 0.5$	V
		Power-down mode	[1] -0.5	+4.6	V
I_O	output current	$V_O = 0$ V to V_{CC}	-	± 20	mA
I_{CC}	supply current		-	+50	mA
I_{GND}	ground current		-50	-	mA
T_{stg}	storage temperature		-65	+150	°C
P_{tot}	total power dissipation	$T_{amb} = -40$ °C to +125 °C	[2] -	250	mW

- [1] The input and output voltage ratings may be exceeded if the input and output current ratings are observed.
 [2] For TSSOP5 packages: above 87.5 °C the value of P_{tot} derates linearly with 4.0 mW/K.
 For XSON6 and X2SON5 packages: above 118 °C the value of P_{tot} derates linearly with 7.8 mW/K.

9. Recommended operating conditions

Table 6. Recommended operating conditions

Symbol	Parameter	Conditions	Min	Max	Unit
V_{CC}	supply voltage		0.8	3.6	V
V_I	input voltage		0	3.6	V
V_O	output voltage	Active mode	0	V_{CC}	V
		Power-down mode; $V_{CC} = 0$ V	0	3.6	V
T_{amb}	ambient temperature		-40	+125	°C
$\Delta t/\Delta V$	input transition rise and fall rate	$V_{CC} = 0.8$ V to 3.6 V	0	200	ns/V

10. Static characteristics

Table 7. Static characteristics

At recommended operating conditions; voltages are referenced to GND (ground = 0 V).

Symbol	Parameter	Conditions	Min	Typ	Max	Unit
T_{amb} = 25 °C						
V _{IH}	HIGH-level input voltage	V _{CC} = 0.8 V	0.70 × V _{CC}	-	-	V
		V _{CC} = 0.9 V to 1.95 V	0.65 × V _{CC}	-	-	V
		V _{CC} = 2.3 V to 2.7 V	1.6	-	-	V
		V _{CC} = 3.0 V to 3.6 V	2.0	-	-	V
V _{IL}	LOW-level input voltage	V _{CC} = 0.8 V	-	-	0.30 × V _{CC}	V
		V _{CC} = 0.9 V to 1.95 V	-	-	0.35 × V _{CC}	V
		V _{CC} = 2.3 V to 2.7 V	-	-	0.7	V
		V _{CC} = 3.0 V to 3.6 V	-	-	0.9	V
V _{OH}	HIGH-level output voltage	V _I = V _{IH} or V _{IL}				
		I _O = -20 μA; V _{CC} = 0.8 V to 3.6 V	V _{CC} - 0.1	-	-	V
		I _O = -1.1 mA; V _{CC} = 1.1 V	0.75 × V _{CC}	-	-	V
		I _O = -1.7 mA; V _{CC} = 1.4 V	1.11	-	-	V
		I _O = -1.9 mA; V _{CC} = 1.65 V	1.32	-	-	V
		I _O = -2.3 mA; V _{CC} = 2.3 V	2.05	-	-	V
		I _O = -3.1 mA; V _{CC} = 2.3 V	1.9	-	-	V
		I _O = -2.7 mA; V _{CC} = 3.0 V	2.72	-	-	V
		I _O = -4.0 mA; V _{CC} = 3.0 V	2.6	-	-	V
V _{OL}	LOW-level output voltage	V _I = V _{IH} or V _{IL}				
		I _O = 20 μA; V _{CC} = 0.8 V to 3.6 V	-	-	0.1	V
		I _O = 1.1 mA; V _{CC} = 1.1 V	-	-	0.3 × V _{CC}	V
		I _O = 1.7 mA; V _{CC} = 1.4 V	-	-	0.31	V
		I _O = 1.9 mA; V _{CC} = 1.65 V	-	-	0.31	V
		I _O = 2.3 mA; V _{CC} = 2.3 V	-	-	0.31	V
		I _O = 3.1 mA; V _{CC} = 2.3 V	-	-	0.44	V
		I _O = 2.7 mA; V _{CC} = 3.0 V	-	-	0.31	V
		I _O = 4.0 mA; V _{CC} = 3.0 V	-	-	0.44	V
I _I	input leakage current	V _I = GND to 3.6 V; V _{CC} = 0 V to 3.6 V	-	-	±0.1	μA
I _{OZ}	OFF-state output current	V _I = V _{IH} or V _{IL} ; V _O = 0 V to 3.6 V; V _{CC} = 0 V to 3.6 V	-	-	±0.1	μA
I _{OFF}	power-off leakage current	V _I or V _O = 0 V to 3.6 V; V _{CC} = 0 V	-	-	±0.2	μA
ΔI _{OFF}	additional power-off leakage current	V _I or V _O = 0 V to 3.6 V; V _{CC} = 0 V to 0.2 V	-	-	±0.2	μA
I _{CC}	supply current	V _I = GND or V _{CC} ; I _O = 0 A; V _{CC} = 0.8 V to 3.6 V	-	-	0.5	μA

Table 7. Static characteristics ...continued

At recommended operating conditions; voltages are referenced to GND (ground = 0 V).

Symbol	Parameter	Conditions	Min	Typ	Max	Unit	
ΔI_{CC}	additional supply current	data input; $V_I = V_{CC} - 0.6$ V; $I_O = 0$ A; $V_{CC} = 3.3$ V	[1]	-	40	μ A	
		\overline{OE} input; $V_I = V_{CC} - 0.6$ V; $I_O = 0$ A; $V_{CC} = 3.3$ V	[1]	-	110	μ A	
		all inputs; $V_I =$ GND to 3.6 V; $\overline{OE} = V_{CC}$; $V_{CC} = 0.8$ V to 3.6 V	[2]	-	1	μ A	
C_I	input capacitance	$V_{CC} = 0$ V to 3.6 V; $V_I =$ GND or V_{CC}	-	0.9	-	pF	
C_O	output capacitance	output enabled	$V_O =$ GND; $V_{CC} = 0$ V	-	1.7	-	pF
		output disabled	$V_{CC} = 0$ V to 3.6 V; $V_O =$ GND or V_{CC}	-	1.5	-	pF
$T_{amb} = -40$ °C to $+85$ °C							
V_{IH}	HIGH-level input voltage	$V_{CC} = 0.8$ V	$0.70 \times V_{CC}$	-	-	V	
		$V_{CC} = 0.9$ V to 1.95 V	$0.65 \times V_{CC}$	-	-	V	
		$V_{CC} = 2.3$ V to 2.7 V	1.6	-	-	V	
		$V_{CC} = 3.0$ V to 3.6 V	2.0	-	-	V	
V_{IL}	LOW-level input voltage	$V_{CC} = 0.8$ V	-	-	$0.30 \times V_{CC}$	V	
		$V_{CC} = 0.9$ V to 1.95 V	-	-	$0.35 \times V_{CC}$	V	
		$V_{CC} = 2.3$ V to 2.7 V	-	-	0.7	V	
		$V_{CC} = 3.0$ V to 3.6 V	-	-	0.9	V	
V_{OH}	HIGH-level output voltage	$V_I = V_{IH}$ or V_{IL}					
		$I_O = -20$ μ A; $V_{CC} = 0.8$ V to 3.6 V	$V_{CC} - 0.1$	-	-	V	
		$I_O = -1.1$ mA; $V_{CC} = 1.1$ V	$0.7 \times V_{CC}$	-	-	V	
		$I_O = -1.7$ mA; $V_{CC} = 1.4$ V	1.03	-	-	V	
		$I_O = -1.9$ mA; $V_{CC} = 1.65$ V	1.30	-	-	V	
		$I_O = -2.3$ mA; $V_{CC} = 2.3$ V	1.97	-	-	V	
		$I_O = -3.1$ mA; $V_{CC} = 2.3$ V	1.85	-	-	V	
		$I_O = -2.7$ mA; $V_{CC} = 3.0$ V	2.67	-	-	V	
V_{OL}	LOW-level output voltage	$V_I = V_{IH}$ or V_{IL}					
		$I_O = 20$ μ A; $V_{CC} = 0.8$ V to 3.6 V	-	-	0.1	V	
		$I_O = 1.1$ mA; $V_{CC} = 1.1$ V	-	-	$0.3 \times V_{CC}$	V	
		$I_O = 1.7$ mA; $V_{CC} = 1.4$ V	-	-	0.37	V	
		$I_O = 1.9$ mA; $V_{CC} = 1.65$ V	-	-	0.35	V	
		$I_O = 2.3$ mA; $V_{CC} = 2.3$ V	-	-	0.33	V	
		$I_O = 3.1$ mA; $V_{CC} = 2.3$ V	-	-	0.45	V	
		$I_O = 2.7$ mA; $V_{CC} = 3.0$ V	-	-	0.33	V	
I_I	input leakage current	$V_I =$ GND to 3.6 V; $V_{CC} = 0$ V to 3.6 V	-	-	± 0.5	μ A	
I_{OZ}	OFF-state output current	$V_I = V_{IH}$ or V_{IL} ; $V_O = 0$ V to 3.6 V; $V_{CC} = 0$ V to 3.6 V	-	-	± 0.5	μ A	
I_{OFF}	power-off leakage current	V_I or $V_O = 0$ V to 3.6 V; $V_{CC} = 0$ V	-	-	± 0.5	μ A	

Table 7. Static characteristics ...continued

At recommended operating conditions; voltages are referenced to GND (ground = 0 V).

Symbol	Parameter	Conditions	Min	Typ	Max	Unit
ΔI_{OFF}	additional power-off leakage current	V_I or $V_O = 0$ V to 3.6 V; $V_{CC} = 0$ V to 0.2 V	-	-	± 0.6	μ A
I_{CC}	supply current	$V_I = GND$ or V_{CC} ; $I_O = 0$ A; $V_{CC} = 0.8$ V to 3.6 V	-	-	0.9	μ A
ΔI_{CC}	additional supply current	data input; $V_I = V_{CC} - 0.6$ V; $I_O = 0$ A; $V_{CC} = 3.3$ V	[1]	-	50	μ A
		\overline{OE} input; $V_I = V_{CC} - 0.6$ V; $I_O = 0$ A; $V_{CC} = 3.3$ V	[1]	-	120	μ A
		all inputs; $V_I = GND$ to 3.6 V; $\overline{OE} = V_{CC}$; $V_{CC} = 0.8$ V to 3.6 V	[2]	-	1	μ A
$T_{amb} = -40$ °C to $+125$ °C						
V_{IH}	HIGH-level input voltage	$V_{CC} = 0.8$ V	$0.75 \times V_{CC}$	-	-	V
		$V_{CC} = 0.9$ V to 1.95 V	$0.70 \times V_{CC}$	-	-	V
		$V_{CC} = 2.3$ V to 2.7 V	1.6	-	-	V
		$V_{CC} = 3.0$ V to 3.6 V	2.0	-	-	V
V_{IL}	LOW-level input voltage	$V_{CC} = 0.8$ V	-	-	$0.25 \times V_{CC}$	V
		$V_{CC} = 0.9$ V to 1.95 V	-	-	$0.30 \times V_{CC}$	V
		$V_{CC} = 2.3$ V to 2.7 V	-	-	0.7	V
		$V_{CC} = 3.0$ V to 3.6 V	-	-	0.9	V
V_{OH}	HIGH-level output voltage	$V_I = V_{IH}$ or V_{IL}				
		$I_O = -20$ μ A; $V_{CC} = 0.8$ V to 3.6 V	$V_{CC} - 0.11$	-	-	V
		$I_O = -1.1$ mA; $V_{CC} = 1.1$ V	$0.6 \times V_{CC}$	-	-	V
		$I_O = -1.7$ mA; $V_{CC} = 1.4$ V	0.93	-	-	V
		$I_O = -1.9$ mA; $V_{CC} = 1.65$ V	1.17	-	-	V
		$I_O = -2.3$ mA; $V_{CC} = 2.3$ V	1.77	-	-	V
		$I_O = -3.1$ mA; $V_{CC} = 2.3$ V	1.67	-	-	V
		$I_O = -2.7$ mA; $V_{CC} = 3.0$ V	2.40	-	-	V
V_{OL}	LOW-level output voltage	$V_I = V_{IH}$ or V_{IL}				
		$I_O = 20$ μ A; $V_{CC} = 0.8$ V to 3.6 V	-	-	0.11	V
		$I_O = 1.1$ mA; $V_{CC} = 1.1$ V	-	-	$0.33 \times V_{CC}$	V
		$I_O = 1.7$ mA; $V_{CC} = 1.4$ V	-	-	0.41	V
		$I_O = 1.9$ mA; $V_{CC} = 1.65$ V	-	-	0.39	V
		$I_O = 2.3$ mA; $V_{CC} = 2.3$ V	-	-	0.36	V
		$I_O = 3.1$ mA; $V_{CC} = 2.3$ V	-	-	0.50	V
		$I_O = 2.7$ mA; $V_{CC} = 3.0$ V	-	-	0.36	V
I_I	input leakage current	$V_I = GND$ to 3.6 V; $V_{CC} = 0$ V to 3.6 V	-	-	± 0.75	μ A
		$V_I = V_{IH}$ or V_{IL} ; $V_O = 0$ V to 3.6 V; $V_{CC} = 0$ V to 3.6 V	-	-	± 0.75	μ A
I_{OFF}	power-off leakage current	V_I or $V_O = 0$ V to 3.6 V; $V_{CC} = 0$ V	-	-	± 0.75	μ A

Table 7. Static characteristics ...continued

At recommended operating conditions; voltages are referenced to GND (ground = 0 V).

Symbol	Parameter	Conditions	Min	Typ	Max	Unit
ΔI_{OFF}	additional power-off leakage current	V_I or $V_O = 0$ V to 3.6 V; $V_{CC} = 0$ V to 0.2 V	-	-	± 0.75	μA
I_{CC}	supply current	$V_I = GND$ or V_{CC} ; $I_O = 0$ A; $V_{CC} = 0.8$ V to 3.6 V	-	-	1.4	μA
ΔI_{CC}	additional supply current	data input; $V_I = V_{CC} - 0.6$ V; $I_O = 0$ A; $V_{CC} = 3.3$ V	[1]	-	75	μA
		\overline{OE} input; $V_I = V_{CC} - 0.6$ V; $I_O = 0$ A; $V_{CC} = 3.3$ V	[1]	-	180	μA
		all inputs; $V_I = GND$ to 3.6 V; $\overline{OE} = V_{CC}$; $V_{CC} = 0.8$ V to 3.6 V	[2]	-	1	μA

[1] One input at $V_{CC} - 0.6$ V, other input at V_{CC} or GND.

[2] To show I_{CC} remains very low when the input-disable feature is enabled.

11. Dynamic characteristics

Table 8. Dynamic characteristics

Voltages are referenced to GND (ground = 0 V); for test circuit see [Figure 10](#)

Symbol	Parameter	Conditions	Min	Typ [1]	Max	Unit
$T_{amb} = 25$ °C; $C_L = 5$ pF						
t_{pd}	propagation delay	A to Y; see Figure 8	[2]			
		$V_{CC} = 0.8$ V	-	20.6	-	ns
		$V_{CC} = 1.1$ V to 1.3 V	2.8	5.5	10.5	ns
		$V_{CC} = 1.4$ V to 1.6 V	2.2	3.9	6.1	ns
		$V_{CC} = 1.65$ V to 1.95 V	1.9	3.2	4.8	ns
		$V_{CC} = 2.3$ V to 2.7 V	1.6	2.6	3.6	ns
		$V_{CC} = 3.0$ V to 3.6 V	1.4	2.4	3.1	ns
t_{en}	enable time	\overline{OE} to Y; see Figure 9	[3]			
		$V_{CC} = 0.8$ V	-	69.9	-	ns
		$V_{CC} = 1.1$ V to 1.3 V	3.1	6.1	11.8	ns
		$V_{CC} = 1.4$ V to 1.6 V	2.5	4.2	6.6	ns
		$V_{CC} = 1.65$ V to 1.95 V	2.1	3.4	5.1	ns
		$V_{CC} = 2.3$ V to 2.7 V	1.8	2.6	3.7	ns
		$V_{CC} = 3.0$ V to 3.6 V	1.7	2.4	3.1	ns
t_{dis}	disable time	\overline{OE} to Y; see Figure 9	[4]			
		$V_{CC} = 0.8$ V	-	14.3	-	ns
		$V_{CC} = 1.1$ V to 1.3 V	2.7	4.3	6.5	ns
		$V_{CC} = 1.4$ V to 1.6 V	2.1	3.2	4.4	ns
		$V_{CC} = 1.65$ V to 1.95 V	2.0	3.0	4.3	ns
		$V_{CC} = 2.3$ V to 2.7 V	1.4	2.2	2.9	ns
		$V_{CC} = 3.0$ V to 3.6 V	1.7	2.5	3.2	ns

Table 8. Dynamic characteristics ...continuedVoltages are referenced to GND (ground = 0 V); for test circuit see [Figure 10](#)

Symbol	Parameter	Conditions	Min	Typ ^[1]	Max	Unit
T_{amb} = 25 °C; C_L = 10 pF						
t _{pd}	propagation delay	A to Y; see Figure 8 ^[2]				
		V _{CC} = 0.8 V	-	24.0	-	ns
		V _{CC} = 1.1 V to 1.3 V	3.2	6.4	12.3	ns
		V _{CC} = 1.4 V to 1.6 V	2.1	4.5	7.3	ns
		V _{CC} = 1.65 V to 1.95 V	1.9	3.8	5.5	ns
		V _{CC} = 2.3 V to 2.7 V	2.1	3.2	4.2	ns
		V _{CC} = 3.0 V to 3.6 V	1.8	3.0	3.8	ns
t _{en}	enable time	$\overline{\text{OE}}$ to Y; see Figure 9 ^[3]				
		V _{CC} = 0.8 V	-	73.7	-	ns
		V _{CC} = 1.1 V to 1.3 V	3.6	6.9	13.5	ns
		V _{CC} = 1.4 V to 1.6 V	2.3	4.8	7.7	ns
		V _{CC} = 1.65 V to 1.95 V	2.0	3.9	5.8	ns
		V _{CC} = 2.3 V to 2.7 V	1.8	3.2	4.3	ns
		V _{CC} = 3.0 V to 3.6 V	1.7	3.0	3.9	ns
t _{dis}	disable time	$\overline{\text{OE}}$ to Y; see Figure 9 ^[4]				
		V _{CC} = 0.8 V	-	32.7	-	ns
		V _{CC} = 1.1 V to 1.3 V	3.4	5.4	7.9	ns
		V _{CC} = 1.4 V to 1.6 V	2.2	4.1	5.5	ns
		V _{CC} = 1.65 V to 1.95 V	2.2	4.2	5.6	ns
		V _{CC} = 2.3 V to 2.7 V	1.7	3.0	3.8	ns
		V _{CC} = 3.0 V to 3.6 V	2.1	3.8	4.8	ns
T_{amb} = 25 °C; C_L = 15 pF						
t _{pd}	propagation delay	A to Y; see Figure 8 ^[2]				
		V _{CC} = 0.8 V	-	27.4	-	ns
		V _{CC} = 1.1 V to 1.3 V	3.6	7.2	14.1	ns
		V _{CC} = 1.4 V to 1.6 V	3.0	5.1	8.1	ns
		V _{CC} = 1.65 V to 1.95 V	2.2	4.3	6.3	ns
		V _{CC} = 2.3 V to 2.7 V	2.0	3.7	4.9	ns
		V _{CC} = 3.0 V to 3.6 V	2.0	3.5	4.4	ns
t _{en}	enable time	$\overline{\text{OE}}$ to Y; see Figure 9 ^[3]				
		V _{CC} = 0.8 V	-	77.5	-	ns
		V _{CC} = 1.1 V to 1.3 V	4.0	7.7	15.2	ns
		V _{CC} = 1.4 V to 1.6 V	3.0	5.3	8.4	ns
		V _{CC} = 1.65 V to 1.95 V	2.3	4.4	6.5	ns
		V _{CC} = 2.3 V to 2.7 V	2.1	3.6	5.0	ns
		V _{CC} = 3.0 V to 3.6 V	2.0	3.5	4.5	ns

Table 8. Dynamic characteristics ...continuedVoltages are referenced to GND (ground = 0 V); for test circuit see [Figure 10](#)

Symbol	Parameter	Conditions	Min	Typ [1]	Max	Unit
t _{dis}	disable time	\overline{OE} to Y; see Figure 9 [4]				
		V _{CC} = 0.8 V	-	60.8	-	ns
		V _{CC} = 1.1 V to 1.3 V	4.3	6.5	9.2	ns
		V _{CC} = 1.4 V to 1.6 V	3.0	5.0	6.5	ns
		V _{CC} = 1.65 V to 1.95 V	3.0	5.3	6.6	ns
		V _{CC} = 2.3 V to 2.7 V	2.1	3.8	4.9	ns
		V _{CC} = 3.0 V to 3.6 V	2.9	5.0	6.2	ns
T_{amb} = 25 °C; C_L = 30 pF						
t _{pd}	propagation delay	A to Y; see Figure 8 [2]				
		V _{CC} = 0.8 V	-	37.4	-	ns
		V _{CC} = 1.1 V to 1.3 V	4.8	9.5	19.0	ns
		V _{CC} = 1.4 V to 1.6 V	4.0	6.7	10.8	ns
		V _{CC} = 1.65 V to 1.95 V	2.9	5.6	8.4	ns
		V _{CC} = 2.3 V to 2.7 V	2.7	4.8	6.3	ns
		V _{CC} = 3.0 V to 3.6 V	2.7	4.6	5.8	ns
t _{en}	enable time	\overline{OE} to Y; see Figure 9 [3]				
		V _{CC} = 0.8 V	-	88.9	-	ns
		V _{CC} = 1.1 V to 1.3 V	5.2	9.9	19.8	ns
		V _{CC} = 1.4 V to 1.6 V	4.0	6.8	10.8	ns
		V _{CC} = 1.65 V to 1.95 V	3.0	5.6	8.5	ns
		V _{CC} = 2.3 V to 2.7 V	2.7	4.8	6.5	ns
		V _{CC} = 3.0 V to 3.6 V	2.7	4.6	6.0	ns
t _{dis}	disable time	\overline{OE} to Y; see Figure 9 [4]				
		V _{CC} = 0.8 V	-	49.9	-	ns
		V _{CC} = 1.1 V to 1.3 V	6.0	9.9	13.3	ns
		V _{CC} = 1.4 V to 1.6 V	4.4	7.7	9.6	ns
		V _{CC} = 1.65 V to 1.95 V	5.1	8.7	11.1	ns
		V _{CC} = 2.3 V to 2.7 V	3.6	6.2	7.4	ns
		V _{CC} = 3.0 V to 3.6 V	5.2	8.7	10.5	ns

Table 8. Dynamic characteristics ...continued

Voltages are referenced to GND (ground = 0 V); for test circuit see [Figure 10](#)

Symbol	Parameter	Conditions	Min	Typ [1]	Max	Unit
T_{amb} = 25 °C						
C _{PD}	power dissipation capacitance	f = 1 MHz; V _I = GND to V _{CC} [5]				
		output enabled				
		V _{CC} = 0.8 V	-	2.7	-	pF
		V _{CC} = 1.1 V to 1.3 V	-	2.8	-	pF
		V _{CC} = 1.4 V to 1.6 V	-	2.9	-	pF
		V _{CC} = 1.65 V to 1.95 V	-	3.0	-	pF
		V _{CC} = 2.3 V to 2.7 V	-	3.6	-	pF
		V _{CC} = 3.0 V to 3.6 V	-	4.2	-	pF

- [1] All typical values are measured at nominal V_{CC}.
- [2] t_{pd} is the same as t_{PLH} and t_{PHL}.
- [3] t_{en} is the same as t_{PZH} and t_{PZL}.
- [4] t_{dis} is the same as t_{PHZ} and t_{PLZ}.
- [5] C_{PD} is used to determine the dynamic power dissipation (P_D in μW).
 $P_D = C_{PD} \times V_{CC}^2 \times f_i \times N + \Sigma(C_L \times V_{CC}^2 \times f_o)$ where:
 f_i = input frequency in MHz;
 f_o = output frequency in MHz;
 C_L = output load capacitance in pF;
 V_{CC} = supply voltage in V;
 N = number of inputs switching;
 Σ(C_L × V_{CC}² × f_o) = sum of the outputs.

Table 9. Dynamic characteristics

Voltages are referenced to GND (ground = 0 V); for test circuit see [Figure 10](#)

Symbol	Parameter	Conditions	-40 °C to +85 °C		-40 °C to +125 °C		Unit
			Min	Max	Min	Max	
C_L = 5 pF							
t _{pd}	propagation delay	A to Y; see Figure 8 [1]					
		V _{CC} = 1.1 V to 1.3 V	2.5	11.7	2.5	12.9	ns
		V _{CC} = 1.4 V to 1.6 V	2.0	7.3	2.0	8.1	ns
		V _{CC} = 1.65 V to 1.95 V	1.7	6.1	1.7	6.7	ns
		V _{CC} = 2.3 V to 2.7 V	1.4	4.3	1.4	4.9	ns
		V _{CC} = 3.0 V to 3.6 V	1.2	3.9	1.2	4.4	ns
t _{en}	enable time	\overline{OE} to Y; see Figure 9 [2]					
		V _{CC} = 1.1 V to 1.3 V	2.9	13.9	2.9	15.4	ns
		V _{CC} = 1.4 V to 1.6 V	2.3	7.7	2.3	8.3	ns
		V _{CC} = 1.65 V to 1.95 V	2.0	6.2	2.0	6.8	ns
		V _{CC} = 2.3 V to 2.7 V	1.7	4.5	1.7	5.0	ns
		V _{CC} = 3.0 V to 3.6 V	1.7	3.5	1.7	3.9	ns

Table 9. Dynamic characteristics ...continued

Voltages are referenced to GND (ground = 0 V); for test circuit see [Figure 10](#)

Symbol	Parameter	Conditions	-40 °C to +85 °C		-40 °C to +125 °C		Unit
			Min	Max	Min	Max	
t _{dis}	disable time	\overline{OE} to Y; see Figure 9 ^[3]					
		V _{CC} = 1.1 V to 1.3 V	2.7	7.3	2.7	8.2	ns
		V _{CC} = 1.4 V to 1.6 V	2.1	5.1	2.1	5.7	ns
		V _{CC} = 1.65 V to 1.95 V	2.0	5.0	2.0	5.7	ns
		V _{CC} = 2.3 V to 2.7 V	1.4	3.3	1.4	4.1	ns
		V _{CC} = 3.0 V to 3.6 V	1.7	3.4	1.7	3.9	ns
C_L = 10 pF							
t _{pd}	propagation delay	A to Y; see Figure 8 ^[1]					
		V _{CC} = 1.1 V to 1.3 V	3.0	13.8	3.0	15.2	ns
		V _{CC} = 1.4 V to 1.6 V	1.9	8.5	1.9	9.4	ns
		V _{CC} = 1.65 V to 1.95 V	1.7	6.8	1.7	7.6	ns
		V _{CC} = 2.3 V to 2.7 V	1.6	5.3	1.6	5.9	ns
		V _{CC} = 3.0 V to 3.6 V	1.6	4.6	1.6	5.2	ns
t _{en}	enable time	\overline{OE} to Y; see Figure 9 ^[2]					
		V _{CC} = 1.1 V to 1.3 V	3.4	15.8	3.4	17.5	ns
		V _{CC} = 1.4 V to 1.6 V	2.2	8.6	2.2	9.4	ns
		V _{CC} = 1.65 V to 1.95 V	1.9	6.8	1.9	7.4	ns
		V _{CC} = 2.3 V to 2.7 V	1.7	5.3	1.7	5.9	ns
		V _{CC} = 3.0 V to 3.6 V	1.7	4.3	1.7	4.8	ns
t _{dis}	disable time	\overline{OE} to Y; see Figure 9 ^[3]					
		V _{CC} = 1.1 V to 1.3 V	3.4	8.8	3.4	9.9	ns
		V _{CC} = 1.4 V to 1.6 V	2.2	6.2	2.2	7.1	ns
		V _{CC} = 1.65 V to 1.95 V	1.9	6.3	1.9	7.1	ns
		V _{CC} = 2.3 V to 2.7 V	1.7	4.5	1.7	5.1	ns
		V _{CC} = 3.0 V to 3.6 V	1.7	5.0	1.7	5.6	ns
C_L = 15 pF							
t _{pd}	propagation delay	A to Y; see Figure 8 ^[1]					
		V _{CC} = 1.1 V to 1.3 V	3.3	15.8	3.3	17.5	ns
		V _{CC} = 1.4 V to 1.6 V	2.5	9.8	2.5	10.9	ns
		V _{CC} = 1.65 V to 1.95 V	2.0	7.9	2.0	8.8	ns
		V _{CC} = 2.3 V to 2.7 V	1.8	6.0	1.8	6.7	ns
		V _{CC} = 3.0 V to 3.6 V	1.8	5.4	1.8	6.1	ns
t _{en}	enable time	\overline{OE} to Y; see Figure 9 ^[2]					
		V _{CC} = 1.1 V to 1.3 V	3.7	17.6	3.7	19.6	ns
		V _{CC} = 1.4 V to 1.6 V	2.5	9.8	2.5	10.7	ns
		V _{CC} = 1.65 V to 1.95 V	2.1	7.7	2.1	8.5	ns
		V _{CC} = 2.3 V to 2.7 V	2.0	6.1	2.0	6.8	ns
		V _{CC} = 3.0 V to 3.6 V	1.9	4.9	1.9	5.5	ns

Table 9. Dynamic characteristics ...continuedVoltages are referenced to GND (ground = 0 V); for test circuit see [Figure 10](#)

Symbol	Parameter	Conditions	-40 °C to +85 °C		-40 °C to +125 °C		Unit
			Min	Max	Min	Max	
t_{dis}	disable time	\overline{OE} to Y; see Figure 9 ^[3]					
		$V_{CC} = 1.1\text{ V to }1.3\text{ V}$	3.7	10.3	3.7	11.6	ns
		$V_{CC} = 1.4\text{ V to }1.6\text{ V}$	2.5	7.4	2.5	8.4	ns
		$V_{CC} = 1.65\text{ V to }1.95\text{ V}$	2.1	7.4	2.1	8.9	ns
		$V_{CC} = 2.3\text{ V to }2.7\text{ V}$	2.0	5.1	2.0	6.4	ns
		$V_{CC} = 3.0\text{ V to }3.6\text{ V}$	1.9	6.6	1.9	7.4	ns
$C_L = 30\text{ pF}$							
t_{pd}	propagation delay	A to Y; see Figure 8 ^[1]					
		$V_{CC} = 1.1\text{ V to }1.3\text{ V}$	4.4	21.6	4.4	24.0	ns
		$V_{CC} = 1.4\text{ V to }1.6\text{ V}$	3.0	13.0	3.0	14.5	ns
		$V_{CC} = 1.65\text{ V to }1.95\text{ V}$	2.6	10.3	2.6	11.5	ns
		$V_{CC} = 2.3\text{ V to }2.7\text{ V}$	2.5	7.8	2.5	8.7	ns
		$V_{CC} = 3.0\text{ V to }3.6\text{ V}$	2.5	7.5	2.5	8.3	ns
t_{en}	enable time	\overline{OE} to Y; see Figure 9 ^[2]					
		$V_{CC} = 1.1\text{ V to }1.3\text{ V}$	4.8	22.8	4.8	25.3	ns
		$V_{CC} = 1.4\text{ V to }1.6\text{ V}$	3.1	12.6	3.1	14.1	ns
		$V_{CC} = 1.65\text{ V to }1.95\text{ V}$	2.8	10.2	2.8	11.3	ns
		$V_{CC} = 2.3\text{ V to }2.7\text{ V}$	2.6	7.8	2.6	8.8	ns
		$V_{CC} = 3.0\text{ V to }3.6\text{ V}$	2.6	6.9	2.6	7.7	ns
t_{dis}	disable time	\overline{OE} to Y; see Figure 9 ^[3]					
		$V_{CC} = 1.1\text{ V to }1.3\text{ V}$	4.8	14.8	4.8	16.5	ns
		$V_{CC} = 1.4\text{ V to }1.6\text{ V}$	3.1	10.7	3.1	12.1	ns
		$V_{CC} = 1.65\text{ V to }1.95\text{ V}$	2.8	12.4	2.8	13.8	ns
		$V_{CC} = 2.3\text{ V to }2.7\text{ V}$	2.6	8.6	2.6	9.6	ns
		$V_{CC} = 3.0\text{ V to }3.6\text{ V}$	2.6	10.8	2.6	13.1	ns

[1] t_{pd} is the same as t_{PLH} and t_{PHL} .[2] t_{en} is the same as t_{PZH} and t_{PZL} .[3] t_{dis} is the same as t_{PHZ} and t_{PLZ} .

12. Waveforms

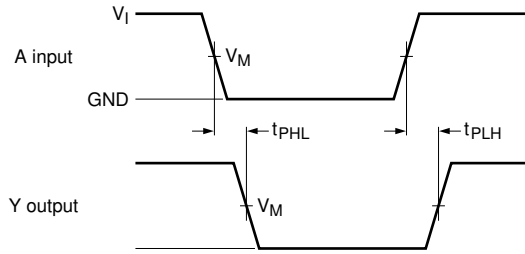

001aad070

Measurement points are given in [Table 10](#).

Logic levels: V_{OL} and V_{OH} are typical output voltage drops that occur with the output load.

Fig 8. The data input (A) to output (Y) propagation delays

Table 10. Measurement points

Supply voltage	Output	Input	V_I	$t_r = t_f$
V_{CC}	V_M	V_M	V_{CC}	≤ 3.0 ns
0.8 V to 3.6 V	$0.5 \times V_{CC}$	$0.5 \times V_{CC}$	V_{CC}	

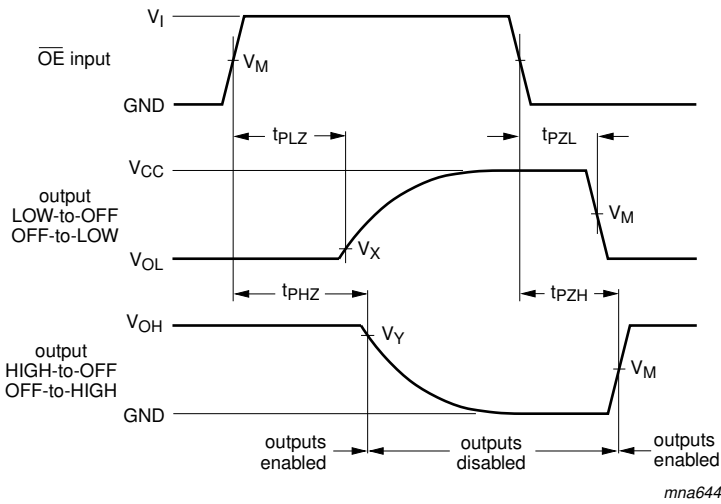

mna644

Measurement points are given in [Table 11](#).

Logic levels: V_{OL} and V_{OH} are typical output voltage drops that occur with the output load.

Fig 9. Enable and disable times

Table 11. Measurement points

Supply voltage	Input	Output		
V_{CC}	V_M	V_M	V_X	V_Y
0.8 V to 1.6 V	$0.5 \times V_{CC}$	$0.5 \times V_{CC}$	$V_{OL} + 0.1 \text{ V}$	$V_{OH} - 0.1 \text{ V}$
1.65 V to 2.7 V	$0.5 \times V_{CC}$	$0.5 \times V_{CC}$	$V_{OL} + 0.15 \text{ V}$	$V_{OH} - 0.15 \text{ V}$
3.0 V to 3.6 V	$0.5 \times V_{CC}$	$0.5 \times V_{CC}$	$V_{OL} + 0.3 \text{ V}$	$V_{OH} - 0.3 \text{ V}$

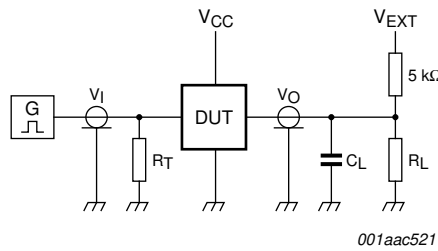

Test data is given in [Table 12](#).

Definitions for test circuit:

R_L = Load resistance.

C_L = Load capacitance including jig and probe capacitance.

R_T = Termination resistance should be equal to the output impedance Z_o of the pulse generator.

V_{EXT} = External voltage for measuring switching times.

Fig 10. Test circuit for measuring switching times

Table 12. Test data

Supply voltage	Load		V_{EXT}			
V_{CC}	C_L	R_L [1]	t_{PLH} , t_{PHL}	t_{PZH} , t_{PHZ}	t_{PZL} , t_{PLZ}	
0.8 V to 3.6 V	5 pF, 10 pF, 15 pF and 30 pF	5 kΩ or 1 MΩ	open	GND	$2 \times V_{CC}$	

[1] For measuring enable and disable times $R_L = 5 \text{ k}\Omega$, for measuring propagation delays, setup and hold times and pulse width $R_L = 1 \text{ M}\Omega$.

13. Package outline

TSSOP5: plastic thin shrink small outline package; 5 leads; body width 1.25 mm

SOT353-1

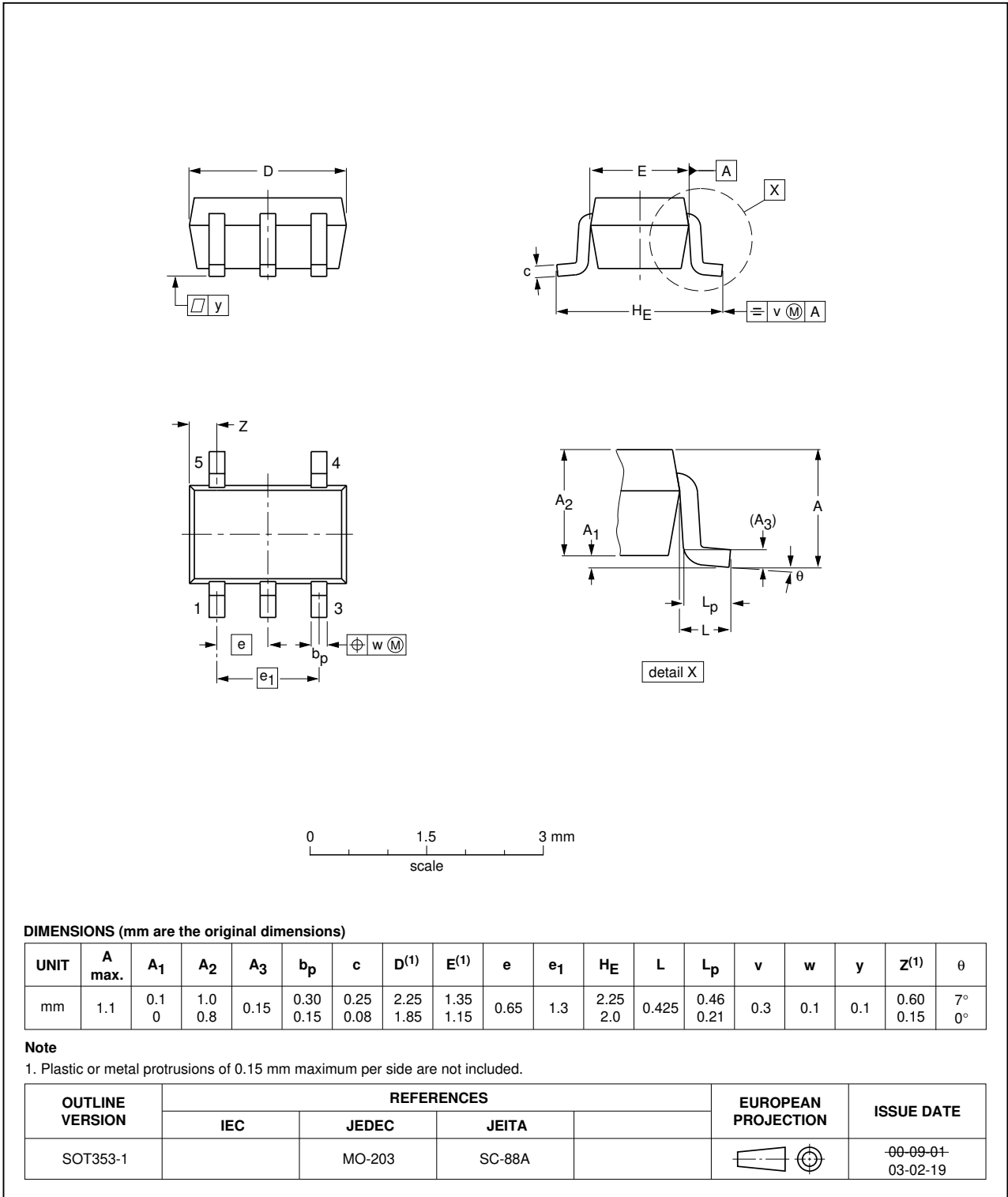

Fig 11. Package outline SOT353-1 (TSSOP5)

XSON6: plastic extremely thin small outline package; no leads; 6 terminals; body 1 x 1.45 x 0.5 mm

SOT886

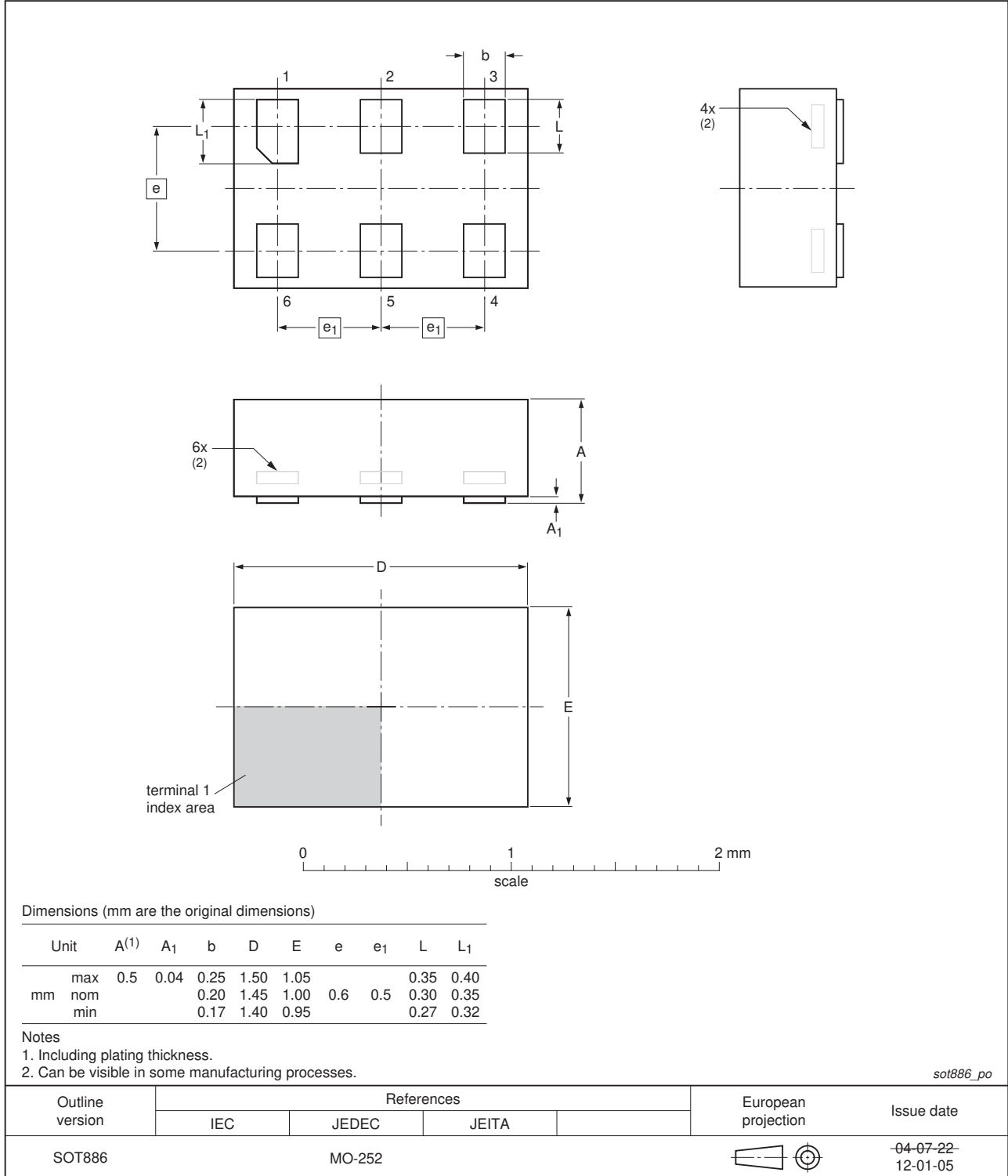

Fig 12. Package outline SOT886 (XSON6)

XSON6: plastic extremely thin small outline package; no leads; 6 terminals; body 1 x 1 x 0.5 mm

SOT891

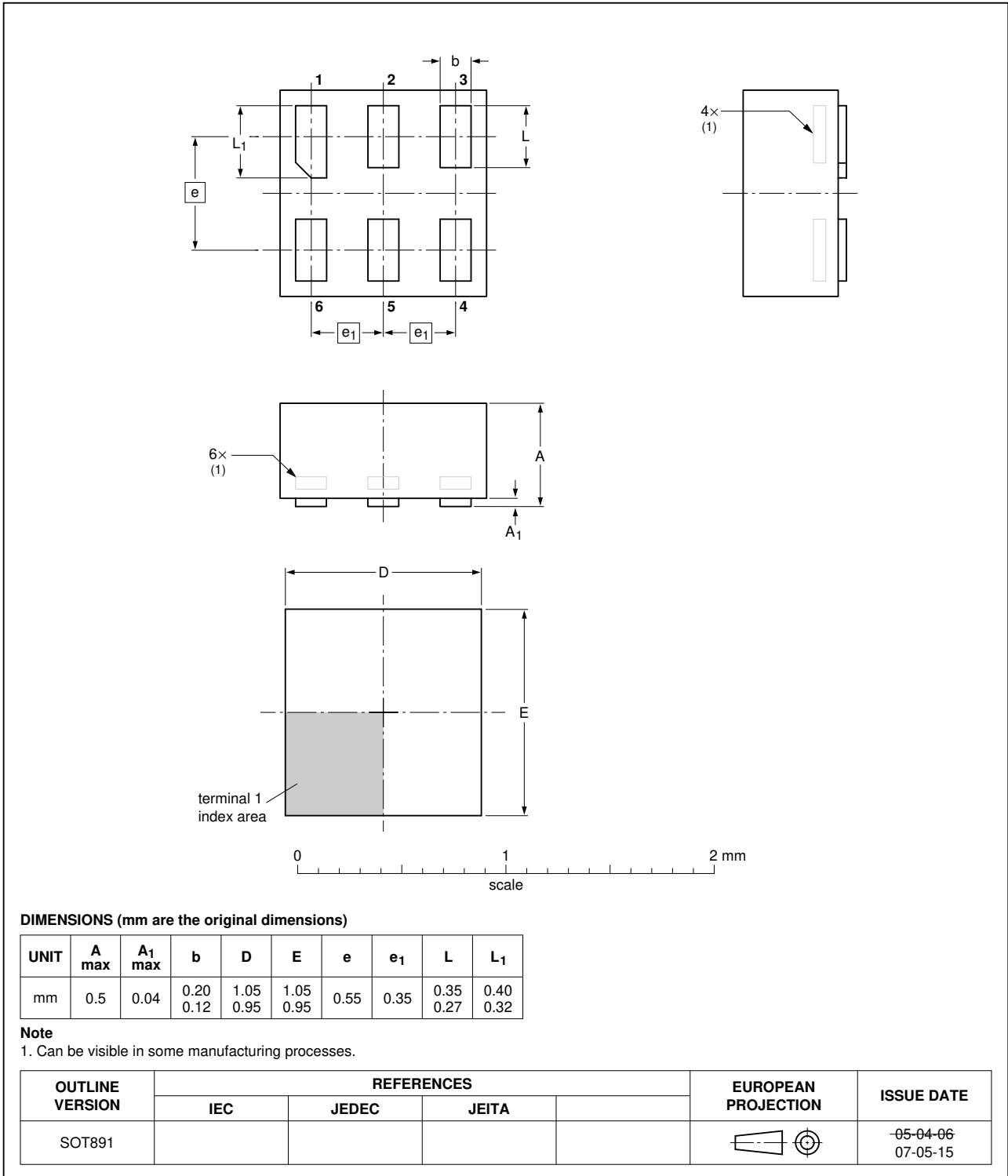

Fig 13. Package outline SOT891 (XSON6)

**XSON6: extremely thin small outline package; no leads;
6 terminals; body 0.9 x 1.0 x 0.35 mm**

SOT1115

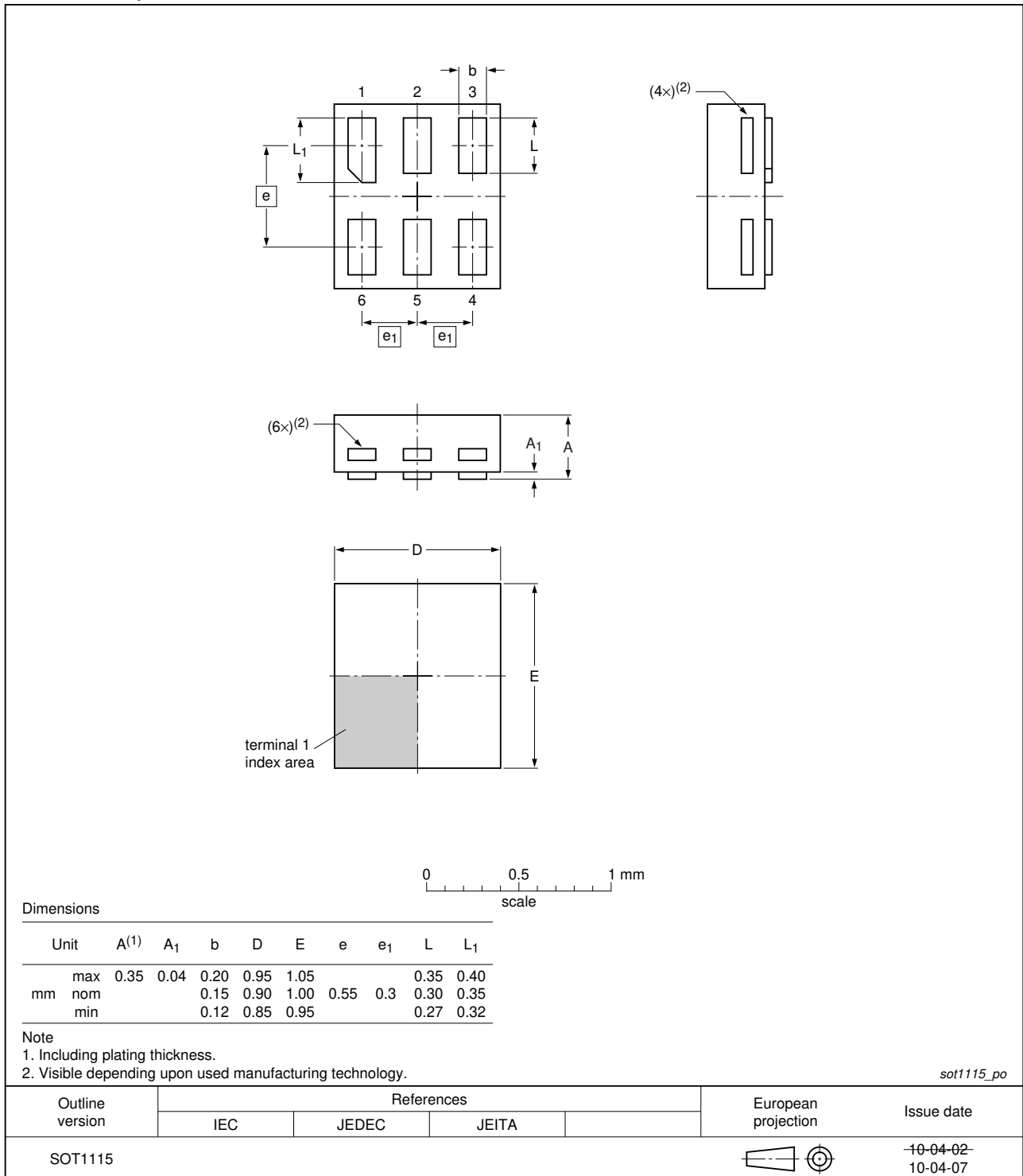

Fig 14. Package outline SOT1115 (XSON6)

**XSON6: extremely thin small outline package; no leads;
6 terminals; body 1.0 x 1.0 x 0.35 mm**

SOT1202

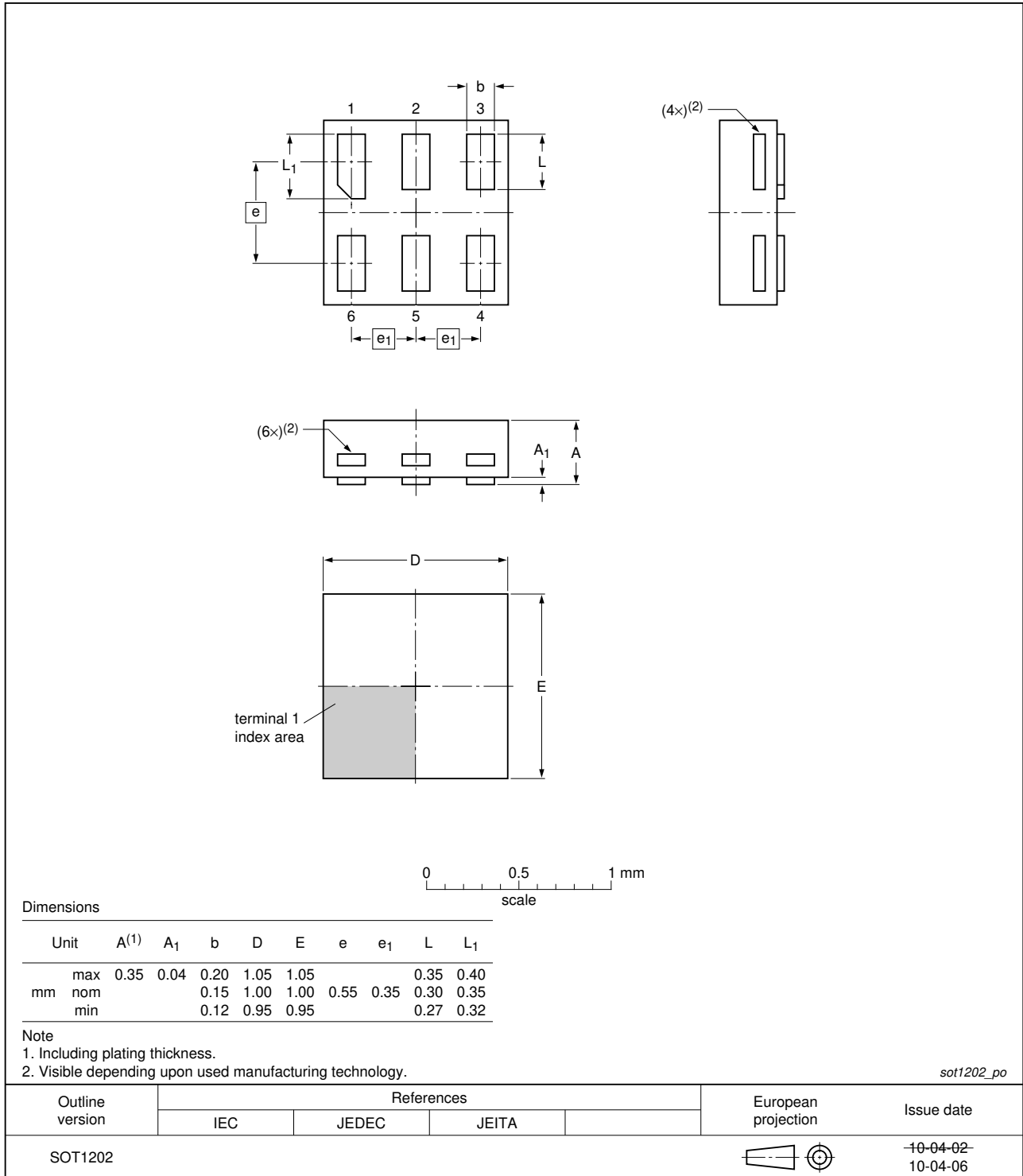

Fig 15. Package outline SOT1202 (XSON6)

X2SON5: plastic thermal enhanced extremely thin small outline package; no leads;
5 terminals; body 0.8 x 0.8 x 0.35 mm

SOT1226

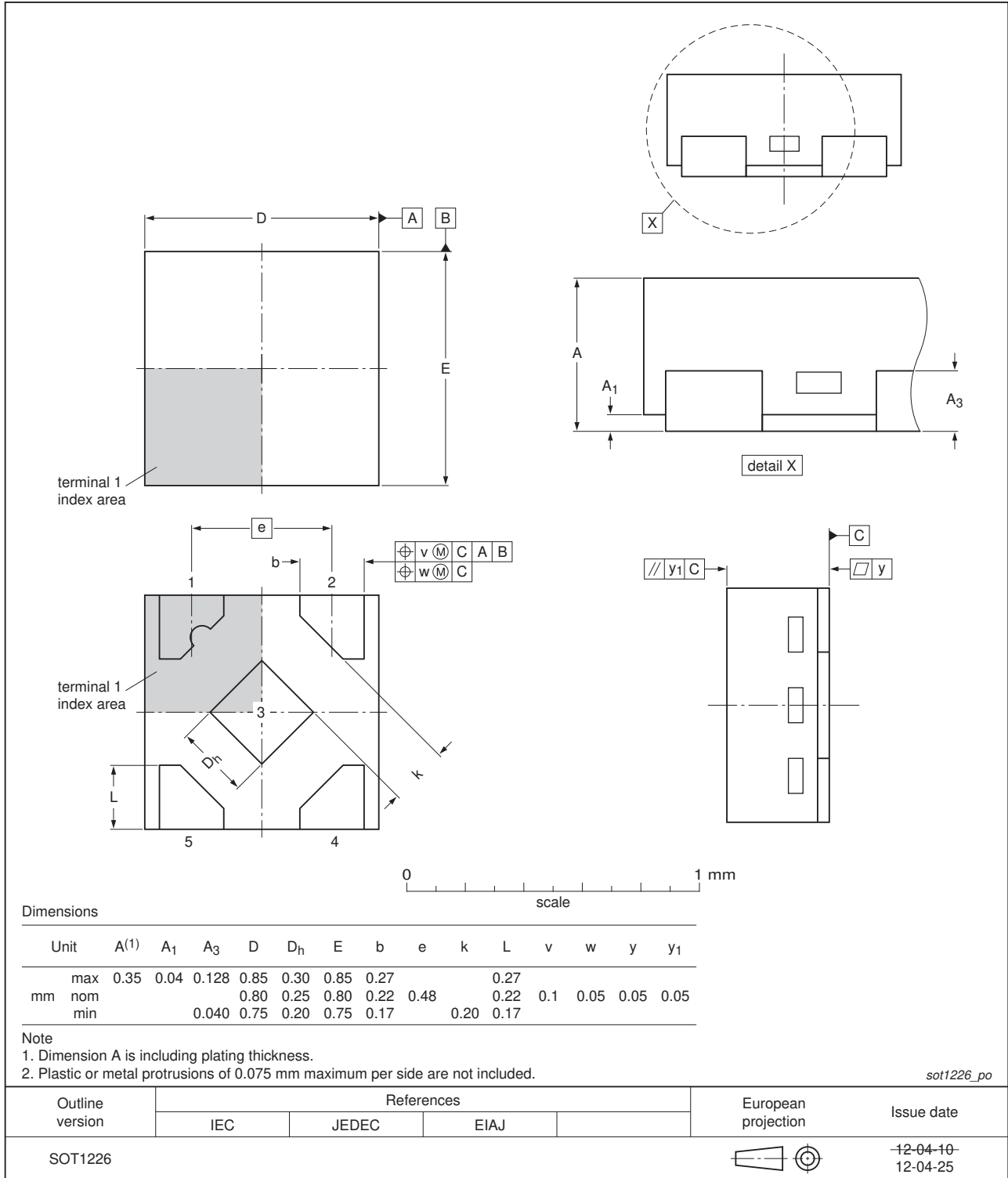

Fig 16. Package outline SOT1226 (X2SON5)

14. Abbreviations

Table 13. Abbreviations

Acronym	Description
CDM	Charged Device Model
DUT	Device Under Test
ESD	ElectroStatic Discharge
HBM	Human Body Model
MM	Machine Model

15. Revision history

Table 14. Revision history

Document ID	Release date	Data sheet status	Change notice	Supersedes
74AUP1G125 v.6	20120815	Product data sheet	-	74AUP1G125 v.5
Modifications:	<ul style="list-style-type: none"> Errata in general description corrected 			
74AUP1G125 v.5	20120731	Product data sheet	-	74AUP1G125 v.4
Modifications:	<ul style="list-style-type: none"> Added type number 74AUP1G125GX (SOT1226) Package outline drawing of SOT886 (Figure 12) modified. 			
74AUP1G125 v.4	20111129	Product data sheet	-	74AUP1G125 v.3
74AUP1G125 v.3	20100901	Product data sheet	-	74AUP1G125 v.2
74AUP1G125 v.2	20060630	Product data sheet	-	74AUP1G125 v.1
74AUP1G125 v.1	20050718	Product data sheet	-	-

16. Legal information

16.1 Data sheet status

Document status ^{[1][2]}	Product status ^[3]	Definition
Objective [short] data sheet	Development	This document contains data from the objective specification for product development.
Preliminary [short] data sheet	Qualification	This document contains data from the preliminary specification.
Product [short] data sheet	Production	This document contains the product specification.

[1] Please consult the most recently issued document before initiating or completing a design.

[2] The term 'short data sheet' is explained in section "Definitions".

[3] The product status of device(s) described in this document may have changed since this document was published and may differ in case of multiple devices. The latest product status information is available on the Internet at URL <http://www.nxp.com>.

16.2 Definitions

Draft — The document is a draft version only. The content is still under internal review and subject to formal approval, which may result in modifications or additions. NXP Semiconductors does not give any representations or warranties as to the accuracy or completeness of information included herein and shall have no liability for the consequences of use of such information.

Short data sheet — A short data sheet is an extract from a full data sheet with the same product type number(s) and title. A short data sheet is intended for quick reference only and should not be relied upon to contain detailed and full information. For detailed and full information see the relevant full data sheet, which is available on request via the local NXP Semiconductors sales office. In case of any inconsistency or conflict with the short data sheet, the full data sheet shall prevail.

Product specification — The information and data provided in a Product data sheet shall define the specification of the product as agreed between NXP Semiconductors and its customer, unless NXP Semiconductors and customer have explicitly agreed otherwise in writing. In no event however, shall an agreement be valid in which the NXP Semiconductors product is deemed to offer functions and qualities beyond those described in the Product data sheet.

16.3 Disclaimers

Limited warranty and liability — Information in this document is believed to be accurate and reliable. However, NXP Semiconductors does not give any representations or warranties, expressed or implied, as to the accuracy or completeness of such information and shall have no liability for the consequences of use of such information. NXP Semiconductors takes no responsibility for the content in this document if provided by an information source outside of NXP Semiconductors.

In no event shall NXP Semiconductors be liable for any indirect, incidental, punitive, special or consequential damages (including - without limitation - lost profits, lost savings, business interruption, costs related to the removal or replacement of any products or rework charges) whether or not such damages are based on tort (including negligence), warranty, breach of contract or any other legal theory.

Notwithstanding any damages that customer might incur for any reason whatsoever, NXP Semiconductors' aggregate and cumulative liability towards customer for the products described herein shall be limited in accordance with the *Terms and conditions of commercial sale* of NXP Semiconductors.

Right to make changes — NXP Semiconductors reserves the right to make changes to information published in this document, including without limitation specifications and product descriptions, at any time and without notice. This document supersedes and replaces all information supplied prior to the publication hereof.

Suitability for use — NXP Semiconductors products are not designed, authorized or warranted to be suitable for use in life support, life-critical or safety-critical systems or equipment, nor in applications where failure or malfunction of an NXP Semiconductors product can reasonably be expected to result in personal injury, death or severe property or environmental damage. NXP Semiconductors and its suppliers accept no liability for inclusion and/or use of NXP Semiconductors products in such equipment or applications and therefore such inclusion and/or use is at the customer's own risk.

Applications — Applications that are described herein for any of these products are for illustrative purposes only. NXP Semiconductors makes no representation or warranty that such applications will be suitable for the specified use without further testing or modification.

Customers are responsible for the design and operation of their applications and products using NXP Semiconductors products, and NXP Semiconductors accepts no liability for any assistance with applications or customer product design. It is customer's sole responsibility to determine whether the NXP Semiconductors product is suitable and fit for the customer's applications and products planned, as well as for the planned application and use of customer's third party customer(s). Customers should provide appropriate design and operating safeguards to minimize the risks associated with their applications and products.

NXP Semiconductors does not accept any liability related to any default, damage, costs or problem which is based on any weakness or default in the customer's applications or products, or the application or use by customer's third party customer(s). Customer is responsible for doing all necessary testing for the customer's applications and products using NXP Semiconductors products in order to avoid a default of the applications and the products or of the application or use by customer's third party customer(s). NXP does not accept any liability in this respect.

Limiting values — Stress above one or more limiting values (as defined in the Absolute Maximum Ratings System of IEC 60134) will cause permanent damage to the device. Limiting values are stress ratings only and (proper) operation of the device at these or any other conditions above those given in the Recommended operating conditions section (if present) or the Characteristics sections of this document is not warranted. Constant or repeated exposure to limiting values will permanently and irreversibly affect the quality and reliability of the device.

Terms and conditions of commercial sale — NXP Semiconductors products are sold subject to the general terms and conditions of commercial sale, as published at <http://www.nxp.com/profile/terms>, unless otherwise agreed in a valid written individual agreement. In case an individual agreement is concluded only the terms and conditions of the respective agreement shall apply. NXP Semiconductors hereby expressly objects to applying the customer's general terms and conditions with regard to the purchase of NXP Semiconductors products by customer.

No offer to sell or license — Nothing in this document may be interpreted or construed as an offer to sell products that is open for acceptance or the grant, conveyance or implication of any license under any copyrights, patents or other industrial or intellectual property rights.

Export control — This document as well as the item(s) described herein may be subject to export control regulations. Export might require a prior authorization from competent authorities.

Non-automotive qualified products — Unless this data sheet expressly states that this specific NXP Semiconductors product is automotive qualified, the product is not suitable for automotive use. It is neither qualified nor tested in accordance with automotive testing or application requirements. NXP Semiconductors accepts no liability for inclusion and/or use of non-automotive qualified products in automotive equipment or applications.

In the event that customer uses the product for design-in and use in automotive applications to automotive specifications and standards, customer (a) shall use the product without NXP Semiconductors' warranty of the product for such automotive applications, use and specifications, and (b) whenever customer uses the product for automotive applications beyond

NXP Semiconductors' specifications such use shall be solely at customer's own risk, and (c) customer fully indemnifies NXP Semiconductors for any liability, damages or failed product claims resulting from customer design and use of the product for automotive applications beyond NXP Semiconductors' standard warranty and NXP Semiconductors' product specifications.

Translations — A non-English (translated) version of a document is for reference only. The English version shall prevail in case of any discrepancy between the translated and English versions.

16.4 Trademarks

Notice: All referenced brands, product names, service names and trademarks are the property of their respective owners.

17. Contact information

For more information, please visit: <http://www.nxp.com>

For sales office addresses, please send an email to: salesaddresses@nxp.com