



Chipsmall Limited consists of a professional team with an average of over 10 year of expertise in the distribution of electronic components. Based in Hongkong, we have already established firm and mutual-benefit business relationships with customers from,Europe,America and south Asia,supplying obsolete and hard-to-find components to meet their specific needs.

With the principle of “Quality Parts,Customers Priority,Honest Operation,and Considerate Service”,our business mainly focus on the distribution of electronic components. Line cards we deal with include Microchip,ALPS,ROHM,Xilinx,Pulse,ON,Everlight and Freescale. Main products comprise IC,Modules,Potentiometer,IC Socket,Relay,Connector.Our parts cover such applications as commercial,industrial, and automotives areas.

We are looking forward to setting up business relationship with you and hope to provide you with the best service and solution. Let us make a better world for our industry!



## Contact us

Tel: +86-755-8981 8866 Fax: +86-755-8427 6832

Email & Skype: info@chipsmall.com Web: www.chipsmall.com

Address: A1208, Overseas Decoration Building, #122 Zhenhua RD., Futian, Shenzhen, China



## Important notice

Dear Customer,

On 7 February 2017 the former NXP Standard Product business became a new company with the tradename **Nexperia**. Nexperia is an industry leading supplier of Discrete, Logic and PowerMOS semiconductors with its focus on the automotive, industrial, computing, consumer and wearable application markets

In data sheets and application notes which still contain NXP or Philips Semiconductors references, use the references to Nexperia, as shown below.

Instead of <http://www.nxp.com>, <http://www.philips.com/> or <http://www.semiconductors.philips.com/>, use <http://www.nexperia.com>

Instead of [sales.addresses@www.nxp.com](mailto:sales.addresses@www.nxp.com) or [sales.addresses@www.semiconductors.philips.com](mailto:sales.addresses@www.semiconductors.philips.com), use [salesaddresses@nexperia.com](mailto:salesaddresses@nexperia.com) (email)

Replace the copyright notice at the bottom of each page or elsewhere in the document, depending on the version, as shown below:

- © NXP N.V. (year). All rights reserved or © Koninklijke Philips Electronics N.V. (year). All rights reserved

Should be replaced with:

- © **Nexperia B.V. (year). All rights reserved.**

If you have any questions related to the data sheet, please contact our nearest sales office via e-mail or telephone (details via [salesaddresses@nexperia.com](mailto:salesaddresses@nexperia.com)). Thank you for your cooperation and understanding,

Kind regards,

Team Nexperia

# DATA SHEET

## **74AVC16244**

**16-bit buffer/line driver; 3-state  
(3.6 V tolerant)**

Product specification  
Supersedes data of 1998 Dec 11  
File under Integrated Circuits, IC24

1999 Nov 15

**16-bit buffer/line driver; 3-state  
(3.6 V tolerant)**

**74AVC16244**

**FEATURES**

- Wide supply voltage range from 1.2 to 3.6 V
- Complies with JEDEC standard no. 8-1A/5/7
- CMOS low power consumption
- Input/output tolerant up to 3.6 V
- Dynamic Controlled Output (DCO) circuit dynamically changes output impedance, resulting in noise reduction without speed degradation
- Low inductance multiple power and ground pins for minimum noise and ground bounce
- Power off disables 74AVC16244 outputs, permitting live insertion.

**DESCRIPTION**

The 74AVC16244 is a 16-bit non-inverting buffer/line driver with 3-state outputs. This device can be used as four 4-bit buffers, two 8-bit buffers or one 16-bit buffer. The 3-state outputs are controlled by the output enable inputs  $n\overline{OE}$ . A HIGH level on input  $n\overline{OE}$  causes the outputs to assume a high-impedance OFF-state.

This product is designed to have an extremely fast propagation delay and a minimum amount of power consumption.

To ensure the high-impedance output state during power-up or power-down, input  $n\overline{OE}$  should be tied to  $V_{CC}$  through a pull-up resistor (live insertion).

A DCO circuitry is implemented to support termination line drive during transient (see Figs 1 and 2).

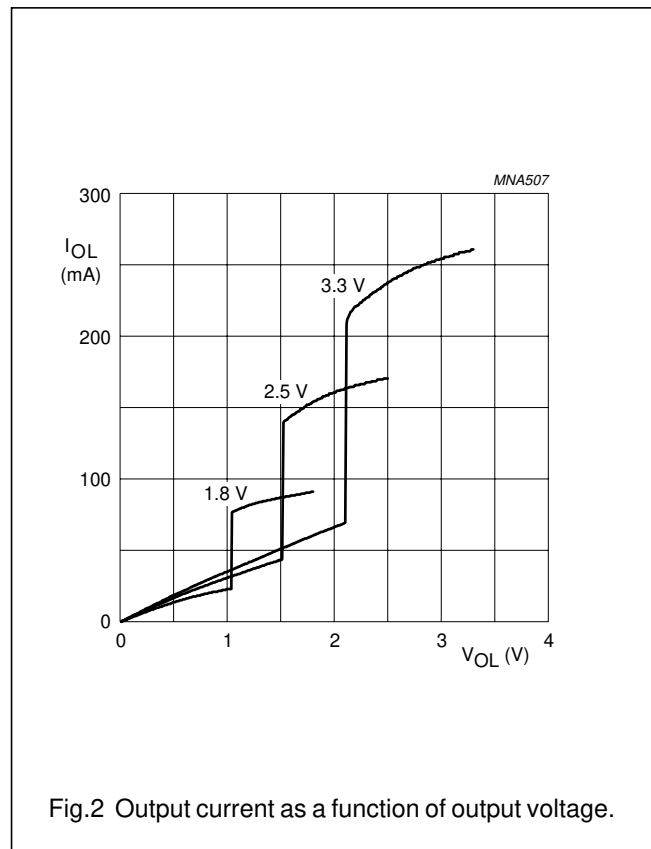
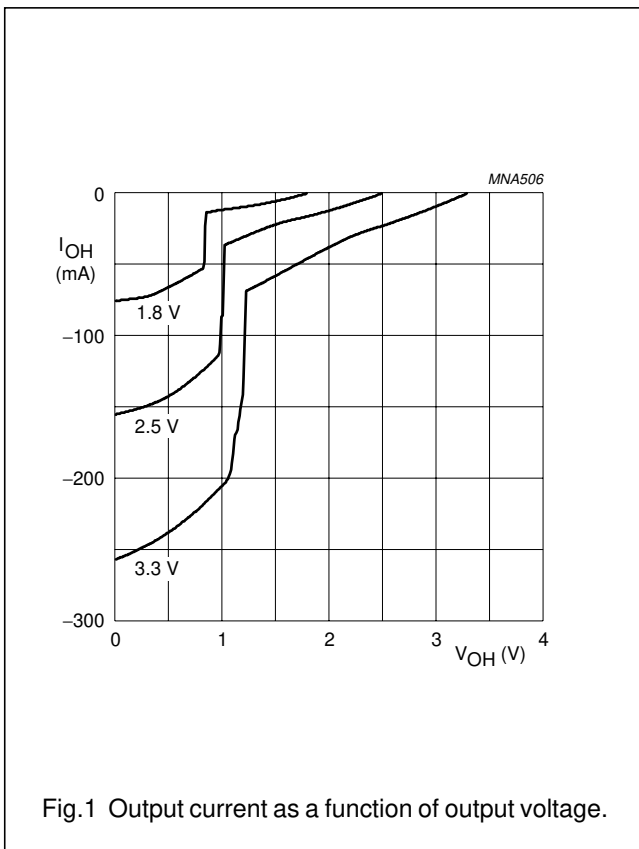

**16-bit buffer/line driver; 3-state  
(3.6 V tolerant)**

**74AVC16244**

**QUICK REFERENCE DATA**

GND = 0 V; T<sub>amb</sub> = 25 °C; t<sub>r</sub> = t<sub>f</sub> ≤ 2.0 ns; C<sub>L</sub> = 30 pF.

SYMBOL	PARAMETER	CONDITIONS	TYP.	UNIT
t <sub>PHL</sub> /t <sub>PLH</sub>	propagation delay nA <sub>n</sub> to nY <sub>n</sub>	V <sub>CC</sub> = 1.2 V	2.6	ns
		V <sub>CC</sub> = 1.5 V	1.8	ns
		V <sub>CC</sub> = 1.8 V	1.7	ns
		V <sub>CC</sub> = 2.5 V	1.3	ns
		V <sub>CC</sub> = 3.3 V	1.1	ns
C <sub>I</sub>	input capacitance		5.0	pF
C <sub>PD</sub>	power dissipation capacitance per buffer	notes 1 and 2 outputs enabled	34	pF
		outputs disabled	1	pF

**Notes**

1. C<sub>PD</sub> is used to determine the dynamic power dissipation (P<sub>D</sub> in μW).

$P_D = C_{PD} \times V_{CC}^2 \times f_i + \sum (C_L \times V_{CC}^2 \times f_o)$  where:

f<sub>i</sub> = input frequency in MHz;

f<sub>o</sub> = output frequency in MHz;

C<sub>L</sub> = output load capacitance in pF;

V<sub>CC</sub> = supply voltage in Volts;

∑ (C<sub>L</sub> × V<sub>CC</sub><sup>2</sup> × f<sub>o</sub>) = sum of outputs.

2. The condition is V<sub>I</sub> = GND to V<sub>CC</sub>.

**FUNCTION TABLE**

See note 1.

INPUTS		OUTPUTS
nOE	nA <sub>n</sub>	nY <sub>n</sub>
L	L	L
L	H	H
H	X	Z

**Note**

1. H = HIGH voltage level;

L = LOW voltage level;

X = don't care;

Z = high-impedance OFF-state.

16-bit buffer/line driver; 3-state  
(3.6 V tolerant)

74AVC16244

**ORDERING INFORMATION**

TYPE NUMBER	PACKAGE				
	TEMPERATURE RANGE	PINS	PACKAGE	MATERIAL	CODE
74AVC16244DGG	-40 to +85 °C	48	TSSOP	plastic	SOT362-1

**PINNING**

PIN	SYMBOL	DESCRIPTION
1	$1\overline{OE}$	output enable input (active LOW)
2, 3, 5 and 6	$1Y_0$ to $1Y_3$	data outputs
4, 10, 15, 21, 28, 34, 39 and 45	GND	ground (0 V)
7, 18, 31 and 42	$V_{CC}$	positive supply voltage
8, 9, 11 and 12	$2Y_0$ to $2Y_3$	data outputs
13, 14, 16 and 17	$3Y_0$ to $3Y_3$	data outputs
19, 20, 22 and 23	$4Y_0$ to $4Y_3$	data outputs
24	$4\overline{OE}$	output enable input (active LOW)
25	$3\overline{OE}$	output enable input (active LOW)
26, 27, 29 and 30	$4A_3$ to $4A_0$	data inputs
32, 33, 35 and 36	$3A_3$ to $3A_0$	data inputs
37, 38, 40 and 41	$2A_3$ to $2A_0$	data inputs
43, 44, 46 and 47	$1A_3$ to $1A_0$	data inputs
48	$2\overline{OE}$	output enable input (active LOW)

16-bit buffer/line driver; 3-state  
(3.6 V tolerant)

74AVC16244

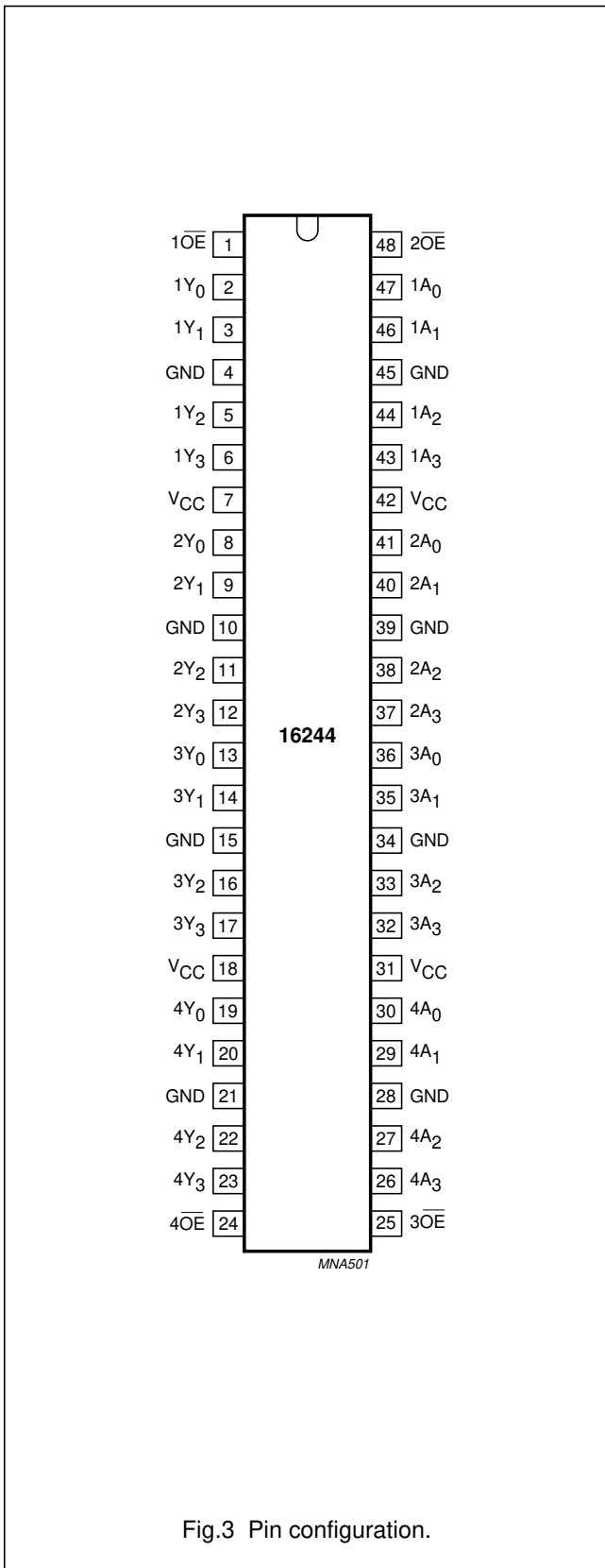

Fig.3 Pin configuration.

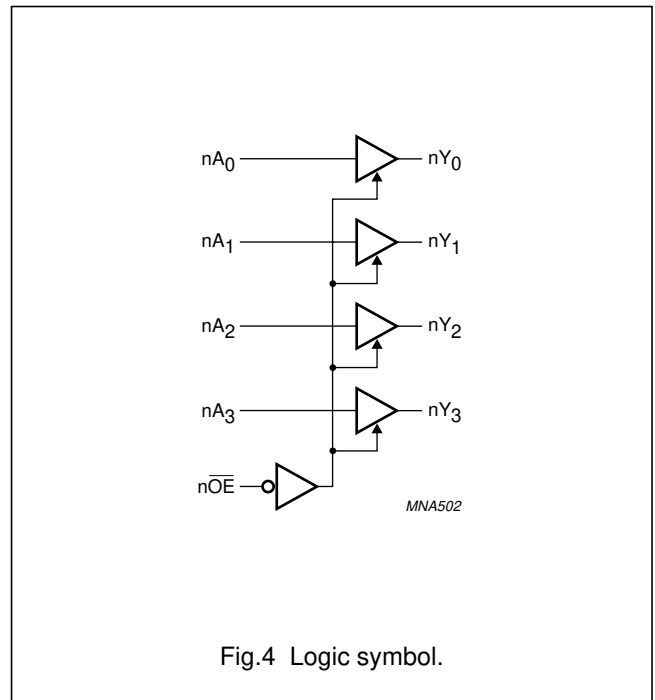

Fig.4 Logic symbol.

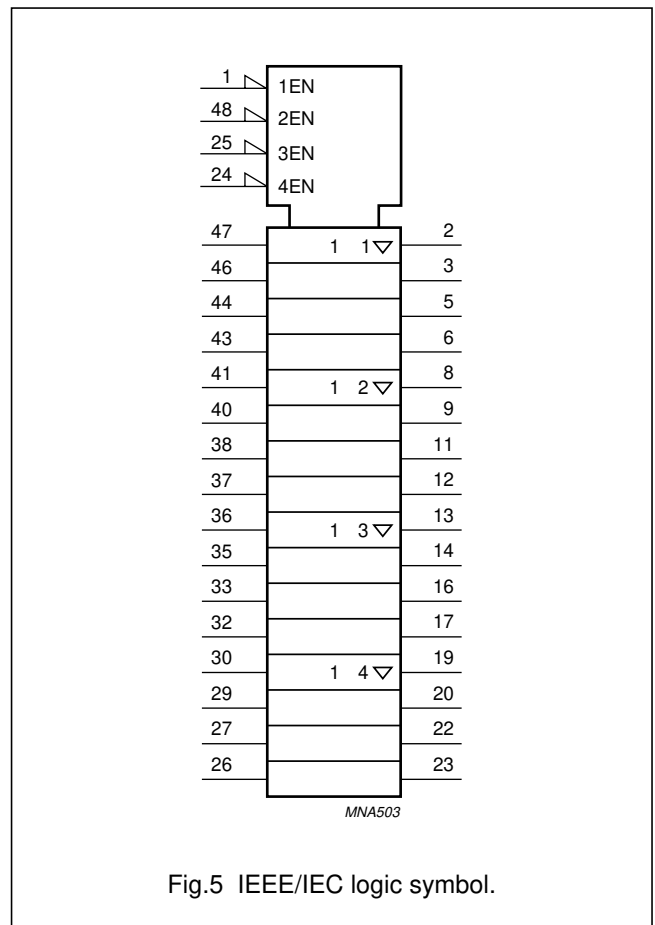

Fig.5 IEEE/IEC logic symbol.

# 16-bit buffer/line driver; 3-state (3.6 V tolerant)

74AVC16244

## RECOMMENDED OPERATING CONDITIONS

SYMBOL	PARAMETER	CONDITIONS	MIN.	MAX.	UNIT
$V_{CC}$	DC supply voltage	according JEDEC low-voltage standards	1.65 2.3 3.0	1.95 2.7 3.6	V V V
		low-voltage applications	1.2	3.6	V
$V_I$	DC input voltage		0	3.6	V
$V_O$	DC output voltage	3-state	0	3.6	V
		HIGH or LOW state	0	$V_{CC}$	V
$T_{amb}$	operating ambient temperature	in free air	-40	+85	°C
$t_r, t_f$	input rise and fall times	$V_{CC} = 1.65$ to $2.3$ V	0	30	ns/V
		$V_{CC} = 2.3$ to $3.0$ V	0	20	ns/V
		$V_{CC} = 3.0$ to $3.6$ V	0	10	ns/V

## LIMITING VALUES

In accordance with the Absolute Maximum Rating System (IEC 134); voltages are referenced to GND (ground = 0 V).

SYMBOL	PARAMETER	CONDITIONS	MIN.	MAX.	UNIT
$V_{CC}$	DC supply voltage		-0.5	+4.6	V
$I_{IK}$	DC input diode current	$V_I < 0$ V	-	-50	mA
$V_I$	DC input voltage	for inputs; note 1	-0.5	+4.6	V
$I_{OK}$	DC output diode current	$V_O > V_{CC}$ or $V_O < 0$ V	-	±50	mA
$V_O$	DC output voltage	HIGH or LOW state; note 1	-0.5	$V_{CC} + 0.5$	V
		3-state; note 1	-0.5	+4.6	V
$I_O$	DC output source or sink current	$V_O = 0$ V to $V_{CC}$	-	±50	mA
$I_{CC}, I_{GND}$	DC $V_{CC}$ or GND current		-	±100	mA
$T_{stg}$	storage temperature		-65	+150	°C
$P_D$	power dissipation per package	temperature range from -40 to +85 °C; note 2	-	500	mW

## Notes

1. The input and output voltage ratings may be exceeded if the input and output current ratings are observed.
2. Above 60 °C the value of  $P_D$  derates linearly with 5.5 mW/K.



# 16-bit buffer/line driver; 3-state (3.6 V tolerant)

74AVC16244

## DC CHARACTERISTICS

Over recommended operating conditions; voltages are referenced to GND (ground = 0 V).

SYMBOL	PARAMETER	TEST CONDITIONS		T <sub>amb</sub> (°C)			UNIT
		OTHER	V <sub>CC</sub> (V)	40 to +85			
				MIN.	TYP. <sup>(1)</sup>	MAX.	
V <sub>IH</sub>	HIGH-level input voltage		1.2	V <sub>CC</sub>	–	–	V
			1.65 to 1.95	0.65V <sub>CC</sub>	0.9	–	V
			2.3 to 2.7	1.7	1.2	–	V
			3.0 to 3.6	2.0	1.5	–	V
V <sub>IL</sub>	LOW-level input voltage		1.2	–	–	GND	V
			1.65 to 1.95	–	0.9	0.35V <sub>CC</sub>	V
			2.3 to 2.7	–	1.2	0.7	V
			3.0 to 3.6	–	1.5	0.8	V
V <sub>OH</sub>	HIGH-level output voltage	V <sub>I</sub> = V <sub>IH</sub> or V <sub>IL</sub> I <sub>O</sub> = –100 μA	1.65 to 3.6	V <sub>CC</sub> – 0.20	V <sub>CC</sub>	–	V
		I <sub>O</sub> = –4 mA	1.65	V <sub>CC</sub> – 0.45	V <sub>CC</sub> – 0.10	–	V
		I <sub>O</sub> = –8 mA	2.3	V <sub>CC</sub> – 0.55	V <sub>CC</sub> – 0.28	–	V
		I <sub>O</sub> = –12 mA	3.0	V <sub>CC</sub> – 0.70	V <sub>CC</sub> – 0.32	–	V
V <sub>OL</sub>	LOW-level output voltage	V <sub>I</sub> = V <sub>IH</sub> or V <sub>IL</sub> I <sub>O</sub> = 100 μA	1.65 to 3.6	–	GND	0.20	V
		I <sub>O</sub> = 4 mA	1.65	–	0.10	0.45	V
		I <sub>O</sub> = 8 mA	2.3	–	0.26	0.55	V
		I <sub>O</sub> = 12 mA	3.0	–	0.36	0.70	V
I <sub>I</sub>	input leakage current per pin	V <sub>I</sub> = V <sub>CC</sub> or GND	1.65 to 3.6	–	0.1	2.5	μA
I <sub>off</sub>	power off leakage current	V <sub>I</sub> or V <sub>O</sub> = 3.6 V	0	–	0.1	±10	μA
I <sub>IHZ</sub> /I <sub>ILZ</sub>	input current for common I/O pins	V <sub>I</sub> = V <sub>CC</sub> or GND	1.65 to 3.6	–	0.1	12.5	μA
I <sub>OZ</sub>	3-state output OFF-state current	V <sub>I</sub> = V <sub>IH</sub> or V <sub>IL</sub> ; V <sub>O</sub> = V <sub>CC</sub> or GND	1.65 to 2.7	–	0.1	5	μA
			3.0 to 3.6	–	0.1	10	μA
I <sub>CC</sub>	quiescent supply current	V <sub>I</sub> = V <sub>CC</sub> or GND; I <sub>O</sub> = 0	1.65 to 2.7	–	0.1	20	μA
			3.0 to 3.6	–	0.2	40	μA

### Note

1. All typical values are measured at T<sub>amb</sub> = 25 °C.

# 16-bit buffer/line driver; 3-state (3.6 V tolerant)

74AVC16244

## AC CHARACTERISTICS

GND = 0 V;  $t_r = t_f \leq 2.0$  ns;  $C_L = 30$  pF.

SYMBOL	PARAMETER	TEST CONDITIONS		$T_{amb}$			UNIT
		WAVEFORMS	$V_{CC}$ (V)	-40 to +85 °C			
				MIN.	TYP. <sup>(1)</sup>	MAX.	
$t_{PHL}/t_{PLH}$	propagation delay $nA_n$ to $nY_n$	see Figs 6 and 8	1.2	–	2.6	–	ns
			1.40 to 1.60	–	1.8	–	ns
			1.65 to 1.95	0.7	1.7	3.1	ns
			2.3 to 2.7	0.6	1.3	1.9	ns
			3.0 to 3.6	0.5	1.1	1.7	ns
$t_{PZH}/t_{PZL}$	3-state output enable time $nOE$ to $nY_n$	see Figs 7 and 8	1.2	–	5.2	–	ns
			1.40 to 1.60	–	3.3	–	ns
			1.65 to 1.95	1.3	2.7	5.5	ns
			2.3 to 2.7	0.9	1.9	4.3	ns
			3.0 to 3.6	0.7	1.7	3.5	ns
$t_{PHZ}/t_{PLZ}$	3-state output disable time $nOE$ to $nY_n$	see Figs 7 and 8	1.2	–	5.7	–	ns
			1.40 to 1.60	–	4.3	–	ns
			1.65 to 1.95	2.0	3.2	6.2	ns
			2.3 to 2.7	1.0	1.9	4.0	ns
			3.0 to 3.6	1.2	1.8	3.5	ns

### Note

- All typical values are measured at  $T_{amb} = 25$  °C and at  $V_{CC} = 1.2$  V, 1.5 V, 1.8 V, 2.5 V or 3.3 V.

## AC WAVEFORMS

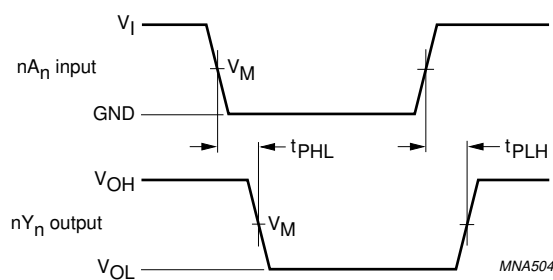

$V_{CC}$	$V_M$	$V_I$
$\leq 2.3$ to 2.7 V	$0.5V_{CC}$	$V_{CC}$
3.0 to 3.6 V	$0.5V_{CC}$	$V_{CC}$

$V_{OL}$  and  $V_{OH}$  are typical output voltage drop that occur with the output load.

Fig.6 The input ( $nA_n$ ) to output ( $nY_n$ ) propagation delay.

16-bit buffer/line driver; 3-state  
(3.6 V tolerant)

74AVC16244

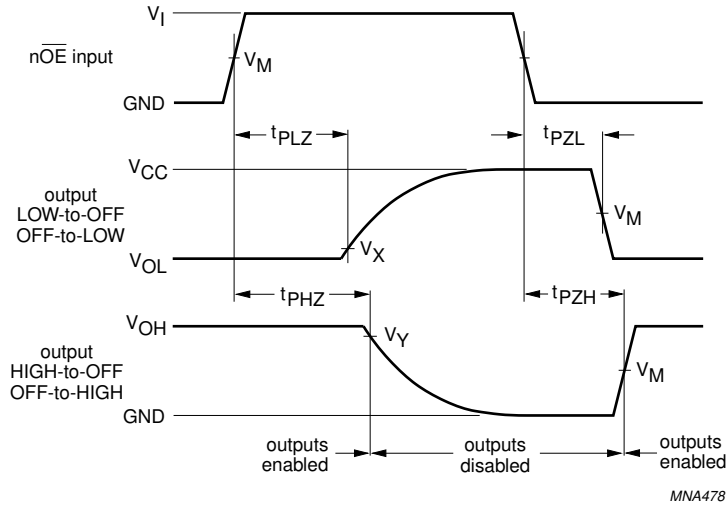

MNA478

V <sub>CC</sub>	V <sub>M</sub>	V <sub>X</sub>	V <sub>Y</sub>	V <sub>I</sub>
≤2.3 to 2.7 V	0.5V <sub>CC</sub>	V <sub>OL</sub> + 0.15 V	V <sub>OH</sub> - 0.15 V	V <sub>CC</sub>
3.0 to 3.6 V	0.5V <sub>CC</sub>	V <sub>OL</sub> + 0.3 V	V <sub>OH</sub> - 0.3 V	V <sub>CC</sub>

V<sub>OL</sub> and V<sub>OH</sub> are typical output voltage drop that occur with the output load.

Fig.7 The 3-state output enable and disable times.

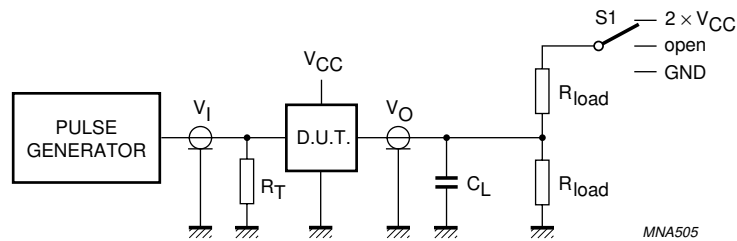

MNA505

TEST	S1	V <sub>CC</sub>	V <sub>I</sub>	R <sub>load</sub>
t <sub>PLH</sub> /t <sub>PHL</sub>	open	<2.3 V	V <sub>CC</sub>	1000 Ω
t <sub>PLZ</sub> /t <sub>PZL</sub>	2 x V <sub>CC</sub>	2.3 to 2.7 V	V <sub>CC</sub>	500 Ω
t <sub>PHZ</sub> /t <sub>PZH</sub>	GND	3.0 to 3.6 V	V <sub>CC</sub>	500 Ω

Definitions for test circuit:  
 C<sub>L</sub> = load capacitance including jig and probe capacitance (See Chapter "AC characteristics");  
 R<sub>T</sub> = termination resistance should be equal to the output impedance Z<sub>o</sub> of the pulse generator.

Fig.8 Test circuitry for switching times.

16-bit buffer/line driver; 3-state  
(3.6 V tolerant)

74AVC16244

PACKAGE OUTLINE

TSSOP48: plastic thin shrink small outline package; 48 leads; body width 6.1 mm

SOT362-1

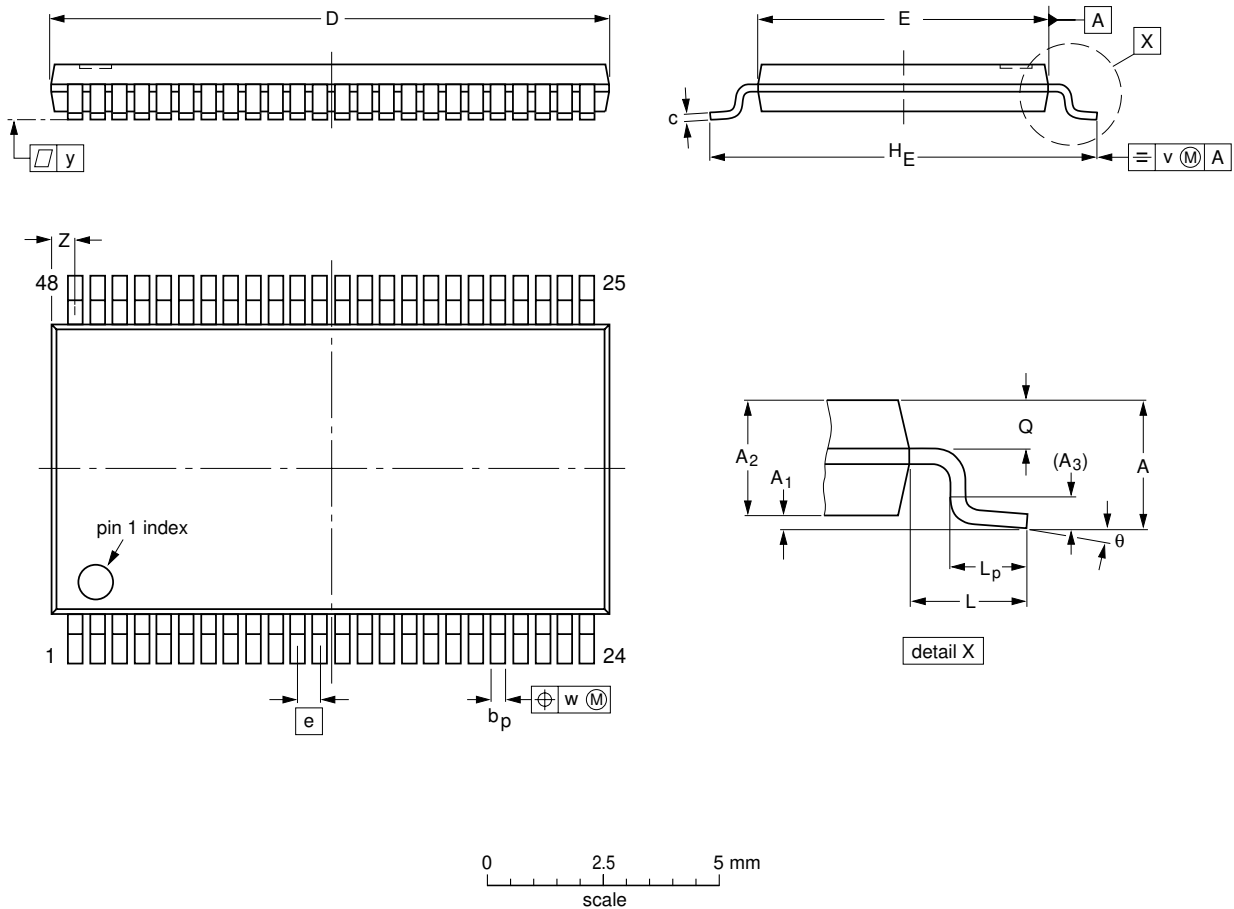

DIMENSIONS (mm are the original dimensions).

UNIT	A max.	A <sub>1</sub>	A <sub>2</sub>	A <sub>3</sub>	b <sub>p</sub>	c	D <sup>(1)</sup>	E <sup>(2)</sup>	e	H <sub>E</sub>	L	L <sub>p</sub>	Q	v	w	y	Z	θ
mm	1.2	0.15 0.05	1.05 0.85	0.25	0.28 0.17	0.2 0.1	12.6 12.4	6.2 6.0	0.5	8.3 7.9	1	0.8 0.4	0.50 0.35	0.25	0.08	0.1	0.8 0.4	8° 0°

Notes

1. Plastic or metal protrusions of 0.15 mm maximum per side are not included.
2. Plastic interlead protrusions of 0.25 mm maximum per side are not included.

OUTLINE VERSION	REFERENCES				EUROPEAN PROJECTION	ISSUE DATE
	IEC	JEDEC	EIAJ			
SOT362-1		MO-153ED				-93-02-03 95-02-10

## 16-bit buffer/line driver; 3-state (3.6 V tolerant)

74AVC16244

### SOLDERING

#### Introduction to soldering surface mount packages

This text gives a very brief insight to a complex technology. A more in-depth account of soldering ICs can be found in our *"Data Handbook IC26; Integrated Circuit Packages"* (document order number 9398 652 90011).

There is no soldering method that is ideal for all surface mount IC packages. Wave soldering is not always suitable for surface mount ICs, or for printed-circuit boards with high population densities. In these situations reflow soldering is often used.

#### Reflow soldering

Reflow soldering requires solder paste (a suspension of fine solder particles, flux and binding agent) to be applied to the printed-circuit board by screen printing, stencilling or pressure-syringe dispensing before package placement.

Several methods exist for reflowing; for example, infrared/convection heating in a conveyor type oven. Throughput times (preheating, soldering and cooling) vary between 100 and 200 seconds depending on heating method.

Typical reflow peak temperatures range from 215 to 250 °C. The top-surface temperature of the packages should preferably be kept below 230 °C.

#### Wave soldering

Conventional single wave soldering is not recommended for surface mount devices (SMDs) or printed-circuit boards with a high component density, as solder bridging and non-wetting can present major problems.

To overcome these problems the double-wave soldering method was specifically developed.

If wave soldering is used the following conditions must be observed for optimal results:

- Use a double-wave soldering method comprising a turbulent wave with high upward pressure followed by a smooth laminar wave.
- For packages with leads on two sides and a pitch (e):
  - larger than or equal to 1.27 mm, the footprint longitudinal axis is **preferred** to be parallel to the transport direction of the printed-circuit board;
  - smaller than 1.27 mm, the footprint longitudinal axis **must** be parallel to the transport direction of the printed-circuit board.

The footprint must incorporate solder thieves at the downstream end.

- For packages with leads on four sides, the footprint must be placed at a 45° angle to the transport direction of the printed-circuit board. The footprint must incorporate solder thieves downstream and at the side corners.

During placement and before soldering, the package must be fixed with a droplet of adhesive. The adhesive can be applied by screen printing, pin transfer or syringe dispensing. The package can be soldered after the adhesive is cured.

Typical dwell time is 4 seconds at 250 °C.

A mildly-activated flux will eliminate the need for removal of corrosive residues in most applications.

#### Manual soldering

Fix the component by first soldering two diagonally-opposite end leads. Use a low voltage (24 V or less) soldering iron applied to the flat part of the lead. Contact time must be limited to 10 seconds at up to 300 °C.

When using a dedicated tool, all other leads can be soldered in one operation within 2 to 5 seconds between 270 and 320 °C.

# 16-bit buffer/line driver; 3-state (3.6 V tolerant)

74AVC16244

## Suitability of surface mount IC packages for wave and reflow soldering methods

PACKAGE	SOLDERING METHOD	
	WAVE	REFLOW <sup>(1)</sup>
BGA, LFBGA, SQFP, TFBGA	not suitable	suitable
HBCC, HLQFP, HSQFP, HSOP, HTQFP, HTSSOP, SMS	not suitable <sup>(2)</sup>	suitable
PLCC <sup>(3)</sup> , SO, SOJ	suitable	suitable
LQFP, QFP, TQFP	not recommended <sup>(3)(4)</sup>	suitable
SSOP, TSSOP, VSO	not recommended <sup>(5)</sup>	suitable

### Notes

- All surface mount (SMD) packages are moisture sensitive. Depending upon the moisture content, the maximum temperature (with respect to time) and body size of the package, there is a risk that internal or external package cracks may occur due to vaporization of the moisture in them (the so called popcorn effect). For details, refer to the Drypack information in the "Data Handbook IC26; Integrated Circuit Packages; Section: Packing Methods".
- These packages are not suitable for wave soldering as a solder joint between the printed-circuit board and heatsink (at bottom version) can not be achieved, and as solder may stick to the heatsink (on top version).
- If wave soldering is considered, then the package must be placed at a 45° angle to the solder wave direction. The package footprint must incorporate solder thieves downstream and at the side corners.
- Wave soldering is only suitable for LQFP, TQFP and QFP packages with a pitch (e) equal to or larger than 0.8 mm; it is definitely not suitable for packages with a pitch (e) equal to or smaller than 0.65 mm.
- Wave soldering is only suitable for SSOP and TSSOP packages with a pitch (e) equal to or larger than 0.65 mm; it is definitely not suitable for packages with a pitch (e) equal to or smaller than 0.5 mm.

### DEFINITIONS

Data sheet status	
Objective specification	This data sheet contains target or goal specifications for product development.
Preliminary specification	This data sheet contains preliminary data; supplementary data may be published later.
Product specification	This data sheet contains final product specifications.
Limiting values	
Limiting values given are in accordance with the Absolute Maximum Rating System (IEC 134). Stress above one or more of the limiting values may cause permanent damage to the device. These are stress ratings only and operation of the device at these or at any other conditions above those given in the Characteristics sections of the specification is not implied. Exposure to limiting values for extended periods may affect device reliability.	
Application information	
Where application information is given, it is advisory and does not form part of the specification.	

### LIFE SUPPORT APPLICATIONS

These products are not designed for use in life support appliances, devices, or systems where malfunction of these products can reasonably be expected to result in personal injury. Philips customers using or selling these products for use in such applications do so at their own risk and agree to fully indemnify Philips for any damages resulting from such improper use or sale.

---

16-bit buffer/line driver; 3-state  
(3.6 V tolerant)

---

74AVC16244

**NOTES**

---

16-bit buffer/line driver; 3-state  
(3.6 V tolerant)

---

74AVC16244

**NOTES**



---

16-bit buffer/line driver; 3-state  
(3.6 V tolerant)

---

74AVC16244

**NOTES**

# Philips Semiconductors – a worldwide company

**Argentina:** see South America

**Australia:** 3 Figtree Drive, HOMEBUSH, NSW 2140,  
Tel. +61 2 9704 8141, Fax. +61 2 9704 8139

**Austria:** Computerstr. 6, A-1101 WIEN, P.O. Box 213,  
Tel. +43 1 60 101 1248, Fax. +43 1 60 101 1210

**Belarus:** Hotel Minsk Business Center, Bld. 3, r. 1211, Volodarski Str. 6,  
220050 MINSK, Tel. +375 172 20 0733, Fax. +375 172 20 0773

**Belgium:** see The Netherlands

**Brazil:** see South America

**Bulgaria:** Philips Bulgaria Ltd., Energoproject, 15th floor,  
51 James Bourchier Blvd., 1407 SOFIA,  
Tel. +359 2 68 9211, Fax. +359 2 68 9102

**Canada:** PHILIPS SEMICONDUCTORS/COMPONENTS,  
Tel. +1 800 234 7381, Fax. +1 800 943 0087

**China/Hong Kong:** 501 Hong Kong Industrial Technology Centre,  
72 Tat Chee Avenue, Kowloon Tong, HONG KONG,  
Tel. +852 2319 7888, Fax. +852 2319 7700

**Colombia:** see South America

**Czech Republic:** see Austria

**Denmark:** Sydhavnsgade 23, 1780 COPENHAGEN V,  
Tel. +45 33 29 3333, Fax. +45 33 29 3905

**Finland:** Sinikalliontie 3, FIN-02630 ESPOO,  
Tel. +358 9 615 800, Fax. +358 9 6158 0920

**France:** 51 Rue Carnot, BP317, 92156 SURESNES Cedex,  
Tel. +33 1 4099 6161, Fax. +33 1 4099 6427

**Germany:** Hammerbrookstraße 69, D-20097 HAMBURG,  
Tel. +49 40 2353 60, Fax. +49 40 2353 6300

**Hungary:** see Austria

**India:** Philips INDIA Ltd, Band Box Building, 2nd floor,  
254-D, Dr. Annie Besant Road, Worli, MUMBAI 400 025,  
Tel. +91 22 493 8541, Fax. +91 22 493 0966

**Indonesia:** PT Philips Development Corporation, Semiconductors Division,  
Gedung Philips, Jl. Buncit Raya Kav.99-100, JAKARTA 12510,  
Tel. +62 21 794 0040 ext. 2501, Fax. +62 21 794 0080

**Ireland:** Newstead, Clonskeagh, DUBLIN 14,  
Tel. +353 1 7640 000, Fax. +353 1 7640 200

**Israel:** RAPAC Electronics, 7 Kehilat Saloniki St, PO Box 18053,  
TEL AVIV 61180, Tel. +972 3 645 0444, Fax. +972 3 649 1007

**Italy:** PHILIPS SEMICONDUCTORS, Via Casati, 23 - 20052 MONZA (MI),  
Tel. +39 039 203 6838, Fax +39 039 203 6800

**Japan:** Philips Bldg 13-37, Kohnan 2-chome, Minato-ku,  
TOKYO 108-8507, Tel. +81 3 3740 5130, Fax. +81 3 3740 5057

**Korea:** Philips House, 260-199 Itaewon-dong, Yongsan-ku, SEOUL,  
Tel. +82 2 709 1412, Fax. +82 2 709 1415

**Malaysia:** No. 76 Jalan Universiti, 46200 PETALING JAYA, SELANGOR,  
Tel. +60 3 750 5214, Fax. +60 3 757 4880

**Mexico:** 5900 Gateway East, Suite 200, EL PASO, TEXAS 79905,  
Tel. +9-5 800 234 7381, Fax +9-5 800 943 0087

**Middle East:** see Italy

**Netherlands:** Postbus 90050, 5600 PB EINDHOVEN, Bldg. VB,  
Tel. +31 40 27 82785, Fax. +31 40 27 88399

**New Zealand:** 2 Wagener Place, C.P.O. Box 1041, AUCKLAND,  
Tel. +64 9 849 4160, Fax. +64 9 849 7811

**Norway:** Box 1, Manglerud 0612, OSLO,  
Tel. +47 22 74 8000, Fax. +47 22 74 8341

**Pakistan:** see Singapore

**Philippines:** Philips Semiconductors Philippines Inc.,  
106 Valero St. Salcedo Village, P.O. Box 2108 MCC, MAKATI,  
Metro MANILA, Tel. +63 2 816 6380, Fax. +63 2 817 3474

**Poland:** Al.Jerozolimskie 195 B, 02-222 WARSAW,  
Tel. +48 22 5710 000, Fax. +48 22 5710 001

**Portugal:** see Spain

**Romania:** see Italy

**Russia:** Philips Russia, Ul. Usatcheva 35A, 119048 MOSCOW,  
Tel. +7 095 755 6918, Fax. +7 095 755 6919

**Singapore:** Lorong 1, Toa Payoh, SINGAPORE 319762,  
Tel. +65 350 2538, Fax. +65 251 6500

**Slovakia:** see Austria

**Slovenia:** see Italy

**South Africa:** S.A. PHILIPS Pty Ltd., 195-215 Main Road Martindale,  
2092 JOHANNESBURG, P.O. Box 58088 Newville 2114,  
Tel. +27 11 471 5401, Fax. +27 11 471 5398

**South America:** Al. Vicente Pinzon, 173, 6th floor,  
04547-130 SÃO PAULO, SP, Brazil,  
Tel. +55 11 821 2333, Fax. +55 11 821 2382

**Spain:** Balmes 22, 08007 BARCELONA,  
Tel. +34 93 301 6312, Fax. +34 93 301 4107

**Sweden:** Kottbygatan 7, Akalla, S-16485 STOCKHOLM,  
Tel. +46 8 5985 2000, Fax. +46 8 5985 2745

**Switzerland:** Allmendstrasse 140, CH-8027 ZÜRICH,  
Tel. +41 1 488 2741 Fax. +41 1 488 3263

**Taiwan:** Philips Semiconductors, 6F, No. 96, Chien Kuo N. Rd., Sec. 1,  
TAIPEI, Taiwan Tel. +886 2 2134 2886, Fax. +886 2 2134 2874

**Thailand:** PHILIPS ELECTRONICS (THAILAND) Ltd.,  
209/2 Sanpavuth-Bangna Road Prakanong, BANGKOK 10260,  
Tel. +66 2 745 4090, Fax. +66 2 398 0793

**Turkey:** Yukari Dudullu, Org. San. Blg., 2.Cad. Nr. 28 81260 Umraniye,  
ISTANBUL, Tel. +90 216 522 1500, Fax. +90 216 522 1813

**Ukraine:** PHILIPS UKRAINE, 4 Patrice Lumumba str., Building B, Floor 7,  
252042 KIEV, Tel. +380 44 264 2776, Fax. +380 44 268 0461

**United Kingdom:** Philips Semiconductors Ltd., 276 Bath Road, Hayes,  
MIDDLESEX UB3 5BX, Tel. +44 208 730 5000, Fax. +44 208 754 8421

**United States:** 811 East Arques Avenue, SUNNYVALE, CA 94088-3409,  
Tel. +1 800 234 7381, Fax. +1 800 943 0087

**Uruguay:** see South America

**Vietnam:** see Singapore

**Yugoslavia:** PHILIPS, Trg N. Pasica 5/v, 11000 BEOGRAD,  
Tel. +381 11 62 5344, Fax.+381 11 63 5777

**For all other countries apply to:** Philips Semiconductors,  
International Marketing & Sales Communications, Building BE-p, P.O. Box 218,  
5600 MD EINDHOVEN, The Netherlands, Fax. +31 40 27 24825

**Internet:** <http://www.semiconductors.philips.com>

© Philips Electronics N.V. 1999

SCA68

All rights are reserved. Reproduction in whole or in part is prohibited without the prior written consent of the copyright owner.

The information presented in this document does not form part of any quotation or contract, is believed to be accurate and reliable and may be changed without notice. No liability will be accepted by the publisher for any consequence of its use. Publication thereof does not convey nor imply any license under patent- or other industrial or intellectual property rights.

Printed in The Netherlands

245004/02/pp16

Date of release: 1999 Nov 15

Document order number: 9397 750 06479

*Let's make things better.*

**Philips  
Semiconductors**



**PHILIPS**